



# BROCHURE

## LED SENSOR SWITCH



[www.surmountor.com](http://www.surmountor.com)



# 2025

ONE-STOP SERVICE

◆ Proximity Sensor Switch / PIR Sensor Switch / Light Sensor Switch  
IR Door Switch / IR Hand Switch/ Button Switch / Hand Switch /  
Touch Dimmer / Mirror Sensor

### Surmountor Lighting Co., Limited

☎ +86-755-27926119 / 27926326    ✉ sales@surmountor.com

🌐 [www.surmountor.com](http://www.surmountor.com) / [www.sur-led.com](http://www.sur-led.com) / [www.ledstrip.cc](http://www.ledstrip.cc)

📍 4/F, No.2 Factory Building, Dayang, No.4 Tangwei Industrial Avenue, FuHai Street, Bao'an, Shenzhen, China.

## OEM&ODM



# TABLE OF CONTENTS

## About Surmountor

Company Overview	01-02
Main Markets Distribution	03-04

## LED Sensor Switch

Proximity Sensor Switch	05-06
PIR Motion Sensor	07-10
Light Sensor Switch	11
IR Hand Sensor	12-16
IR Door Sensor	17-20
IR Hand/Door Sensor	21-23
Mirror Sensor Switch	24
Touch Dimmer	25-31
Button Switch	34-36
PIR motion sensor for running water step light system	37-40

# ABOUT OUR COMPANY



## We have an excellent team!

Our energetic and creative sales team understand customers' demands deeply and solve problems promptly. Every customer will be concerned and respected seriously, patiently, responsibly from enquiry-design-sampling-order-production-export-after sales service. Based on all our efforts, we attained great achievements and progress in the past 10 years, and also help our customers to expand their markets by constantly developing new products.



## Our strength and pursuit!

Our main strength is equipped with professional engineers, can provide customers with customized lighting solutions and win the market with clients together. Our goal is to build long term win-win relationship with our customers.



## We are professional manufacturer!

Surmountor Lighting Co.,LTD was founded in 2011, and has been diligently devoted in the LED lighting industry. With over 10 years experience, We are specialized in LED LED Neon Flex,Linear Lighting, LED Flexible Strip, LED Sensor Switches and LED Aluminum Profile, . And our products are widely used in outdoor or indoor lighting, hotel lighting, office lighting, shop lighting, kitchen lighting, etc.

Our factory is over 8000 m<sup>2</sup>, with more than 100 employees. What's more, with the aim to be continuously competitive, our company is equipped with 10 professional R&D staffs. Our factory production monthly capacity reach more than 120,000 meters of flexible LED strips, 150,000 meters LED profiles, 100,000 pieces sensor switches, 36000 meters of neon light and so on.

## One-stop production and Continuous innovation!

With wide range led products line, we concentrate on offering one stop and one package service. To fulfil our worldwide partners different needs, our R&D departments always committed to continuously creating and innovating new products. In 2017, we developed LED Neon Lights. All of our neon flex products are of matte-finished texture, which helps feeling elegant and of higher quality level.



## We have ISO quality control System!

Our LED products are quality oriented and have passed a series of certifications, including CE, RoHS, UL, ISO9001:2015 management system, etc. We are committed to continuously providing our customers with high performance and reliable quality products. By offering competitive price, stable quality, timely delivery and good service, we gained good reputation among our customers all over the world, such as Europe, North America, Latin America, Australia, Middle East and Southeast Asia



# MAIN MARKETS DISTRIBUTION

Based on excellent quality and dedicated service, Surmountor is highly recognized and favored by foreign customers, enjoys a high reputation and fame in overseas markets, and has become one of the global consumers ' reliable led brands. Products are exported to Europe, North America, Latin America, Australia, Middle East and more than 50 countries.



Cooperation Partners  
**> 90**

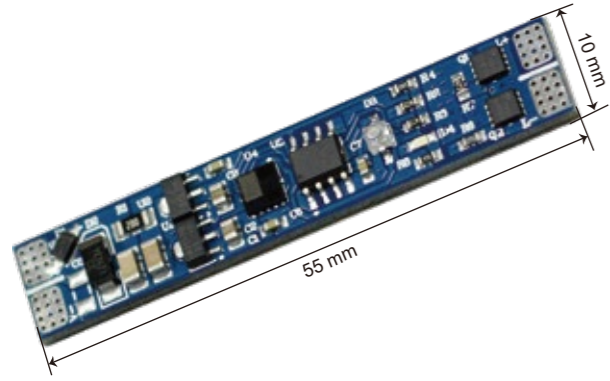

## Proximity sensor switch: PS001

- 1 , Input voltage: 12-24V DC.
- 2 , Current: 8A max.
- 3 , Power: 96W for 12V, and 192 W for 24V.
- 4 , Detection range:  $\leq 18\text{cm}$ (when there is no pc cover).
- 5 , Turn on/off the light when hand pass over the sensor within 18cm.

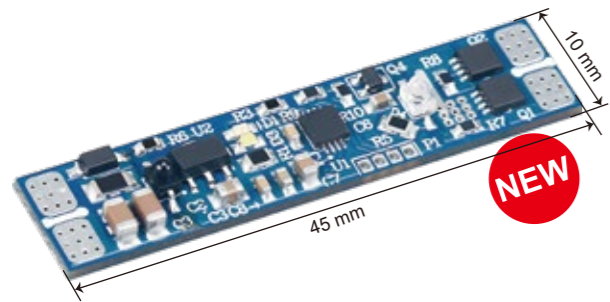

## Proximity sensor switch: EPS002

- 1 , Input voltage: 12-24V DC.
- 2 , Current: 6A max.
- 3 , Power: 72W for 12V, and 144W for 24V.
- 4 , Operating max height: 12cm (without any cover, If the surface has a cover, the sensing distance is 4-5cm).
- 5 , Support operation: turn on/off : swipe hand left and right  
dimming: keep hand on the sensor switch over 1.5 seconds.
- 6 , Dimming range: 0.8-100%.
- 7 , 0V memory: memory after 5 seconds of no operation.
- 8 , Suggestion: recommend to use a PC cover with transmittance above 70%.

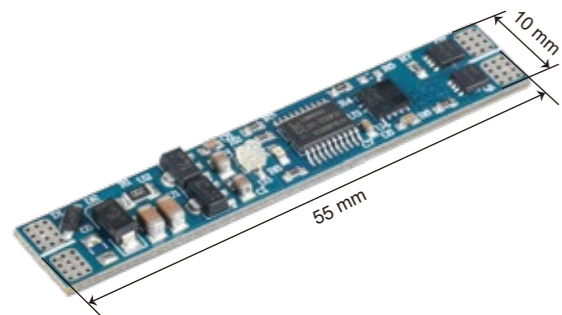

## Proximity sensor switch: PS002

- 1 , Input voltage: 12-24V DC.
- 2 , Current: 8A max.
- 3 , Power: 96W for 12V, and 192W for 24V.
- 4 , Detection range:  $\leq 18\text{cm}$ (when there is no pc cover).
- 5 , Turn on/off the light when hand pass over the sensor within 18cm.
- 6 , Hold the hand over the sensor more than 1 seconda, djusting the brightness from 3 % to 100%.
- 7 , With 0V memory function.

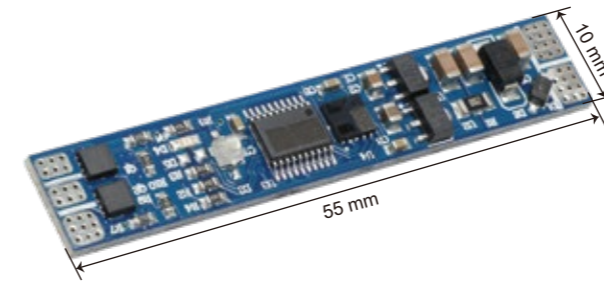

## Proximity sensor switch: PS003

- 1 , Input voltage: 12-24V DC.
- 2 , Current: 4A max each channel.
- 3 , Power: 48W for 12V, and 96W for 24V.
- 4 , Detection range:  $\leq 18\text{cm}$ (when there is no pc cover).
- 5 , Turn on/off the light when hand pass over the sensor within 18cm.
- 6 , Hold the hand over the sensor switch within 18cm more than 1 second, adjusting the double color LED light brightness of one LED color from 0% to 100% and of another LED color from 100% to 0 %; only the LED color temperature is adjustable, the blue LED on the switch is flashing at the same time.
- 7 , With 0V memory function.

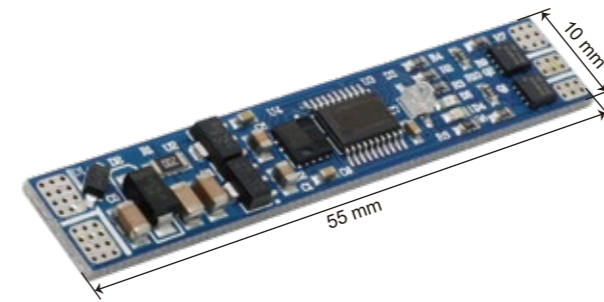

## Proximity sensor switch: PS004

- 1 , Input voltage: 12-24V DC.
- 2 , Current: 4A max each channel.
- 3 , Power: 48W for 12V, and 96W for 24V.
- 4 , Detection range:  $\leq 18\text{cm}$ (when there is no pc cover).
- 5 , Turn on/off . the light when hand pass over the sensor once in 1.5 seconds.
- 6 , Switching dimming mode when hand pass over the sensor round trip twice in 1.5 seconds.
- 7 , With 0V memory function.

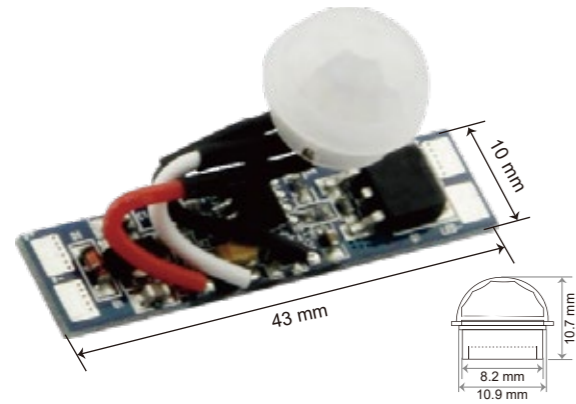

## PIR sensor switch: PIR001

- 1, Input voltage: 12-24V DC.
- 2, Current: 8A max.
- 3, Power: 96W for 12V, and 192W for 24V.
- 4, Detection range:  $\leq 2m$ .
- 5, Delay time: about 40 seconds.
- 6, Automatically on/off.

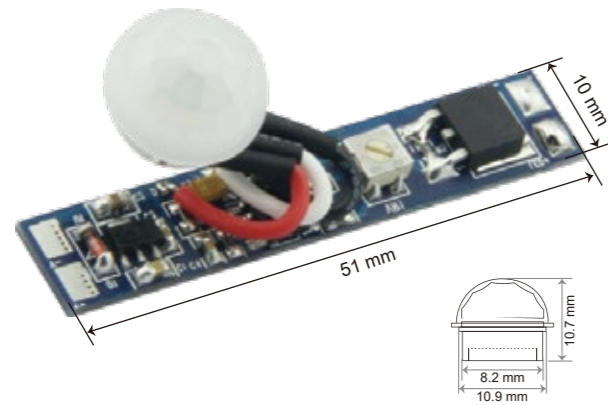

## PIR sensor switch: PIR001T

- 1, Input voltage: 12-24V DC.
- 2, Current: 8A max.
- 3, Power: 96W for 12V, and 192W for 24V.
- 4, Detection range:  $\leq 2m$ .
- 5, Delay time: adjustable about 6-70s.
- 6, Automatically on/off.

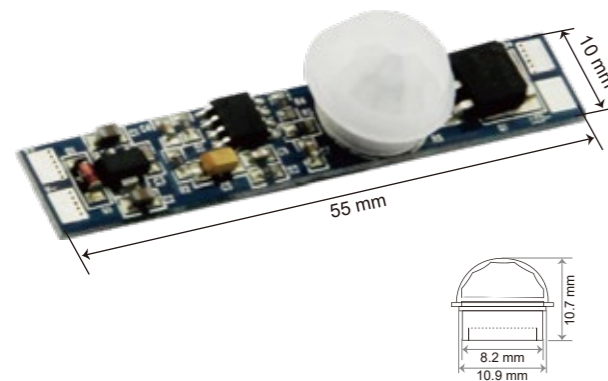

## PIR sensor switch: PIR002

- 1, Input voltage: 12-24V DC.
- 2, Current: 2.5A max.
- 3, Power: 30W for 12V, and 60W for 24V.
- 4, Detection range:  $\leq 2m$ .
- 5, Delay time: about 40 seconds.
- 6, Automatically on/off.

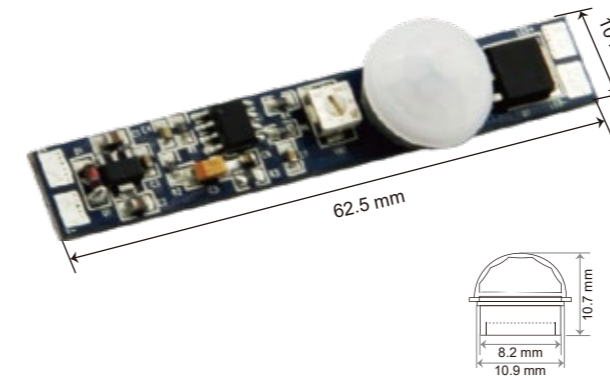

## PIR sensor switch: PIR002T

- 1, Input voltage: 12-24V DC.
- 2, Current: 2.5A max.
- 3, Power: 30W for 12V, and 60W for 24V.
- 4, Detection range:  $\leq 2m$ .
- 5, Delay time: adjustable about 6-70s.
- 6, Automatically on/off.



## Recessed PIR sensor switch: PIR003

- 1, Outside dimension: 16x60mm.
- 2, Input voltage: 12-24V DC.
- 3, Current: 4A max.
- 4, Power: 48W for 12V, and 96W for 24V.
- 5, Detection range:  $\leq 2m$ .
- 6, Delay time: about 40 seconds.
- 7, Automatically on/off.
- 8, Cable length: 1m with mini connector.



## Surface mounting PIR sensor switch: PIR004

- 1, Input voltage: 12-24V DC.
- 2, Current: 4A max.
- 3, Power: 48W for 12V, and 96W for 24V.
- 4, Detection range:  $\leq 2m$ .
- 5, Delay time: about 40 seconds.
- 6, Automatically on/off.
- 7, Cable length: 1m with mini connector.

## PIR MOTION SENSOR

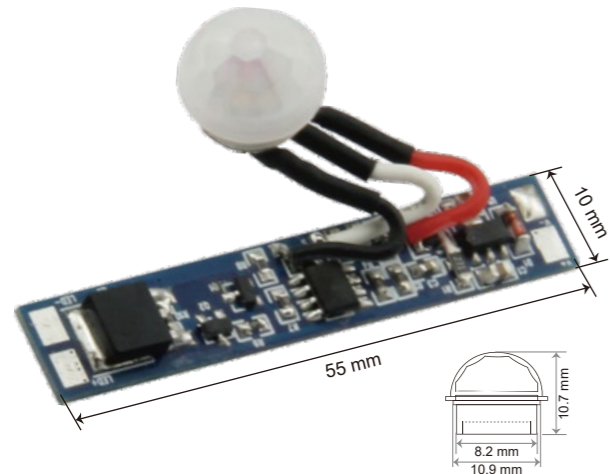

### PIR sensor switch: PIR005

- 1, Input voltage: 12-24V DC.
- 2, Current: 8A max.
- 3, Power: 96W for 12V, and 192W for 24V.
- 4, Detection range:  $\leq 2m$ .
- 5, Delay time: about 40 seconds.
- 6, Automatically on/off.
- 7, The light will be turn on in 2 seconds slowly from 0% to 100% when people move inside 2 meters PIR sensor detective range. The light will turn off slowly in 8 to 10 seconds after people leave PIR sensor detective range 40 seconds.



### Recessed PIR sensor switch: PIR006A

- 1, Input voltage: 12-24V DC.
- 2, Current: 4A max.
- 3, Power: 48W for 12V, and 96W for 24V.
- 4, Detection range:  $\leq 2m$ .
- 5, Delay time: about 40 seconds.
- 6, Automatically on/off.
- 7, Input and output cable length: 1m(cable length can be customized).



### Recessed PIR sensor switch: PIR006B

- 1, Input voltage: 12-24V DC.
- 2, Current: 4A max.
- 3, Power: 48W for 12V, and 96W for 24V.
- 4, Detection range:  $\leq 2m$ .
- 5, Delay time: about 40 seconds.
- 6, Automatically on/off.
- 7, Input and output cable length: 25cm(cable length can be customized).
- 8, LED sensor detector cable length: 1m(cable length can be customized).



### PIR sensor switch: PIR010

- 1, Input voltage: 5-24V DC.
- 2, Current: 4A max.
- 3, Power: 20W for 5V, and 96W for 24V.
- 4, Detection range:  $\leq 6m$ .
- 5, Sensing angle: 100°.
- 6, Delay time: 30s, 60s, 380s for option.
- 7, Automatically on/off.

## LIGHT SENSOR SWITCH

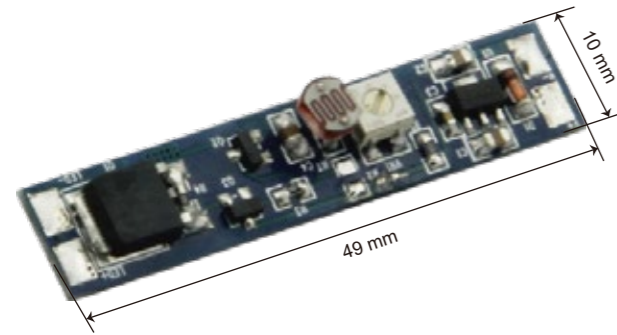

### Light sensor switch: LSS001

- 1, Input voltage: 12-24V DC.
- 2, Current: 8A max.
- 3, Power: 96W for 12V, and 192W for 24V.
- 4, Lux range: 2 ~ 60 lux.
- 5, Light is on at night, light is off in day time.

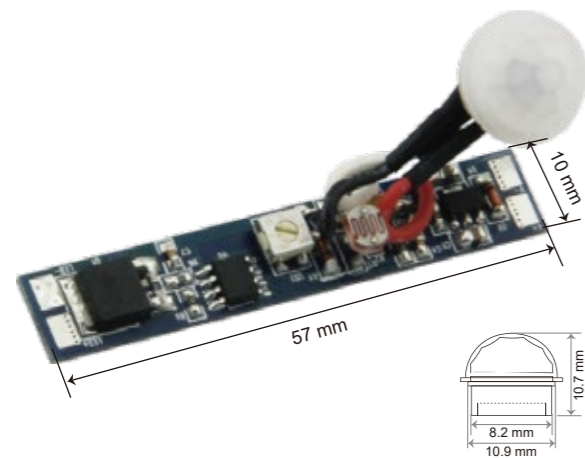

### Motion sensor with light sensor switch: LSS002

- 1, Input voltage: 12-24V DC.
- 2, Current: 8A max.
- 3, Power: 96W for 12V, and 192W for 24V.
- 4, Detection range:  $\leq 2\text{m}$ .
- 5, Lux range: 2 ~ 60 lux.
- 6, Delay time: about 40 seconds.
- 7, Light is off in day time, light is on when human body pass. within detection range at night.

滚滚长江东逝水

## IR HAND SENSOR

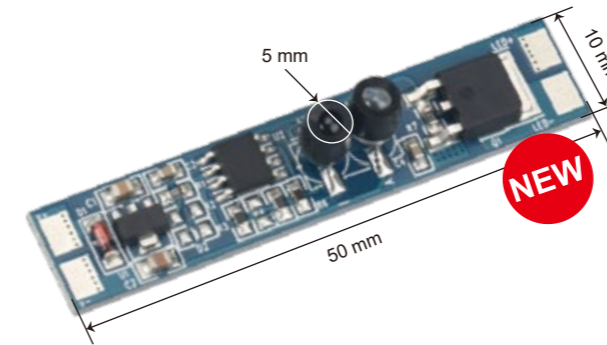

### Internal IR hand sensor switch: EIR001

- 1, Input voltage: 12-24V DC.
- 2, Current: 8A max.
- 3, Power: 96W for 12V, and 192W for 24V.
- 4, Detection range:  $0.5\text{cm} \leq \text{detection range} \leq 10\text{cm}$ .
- 5, Automatically switch on/off when the hand pass over.

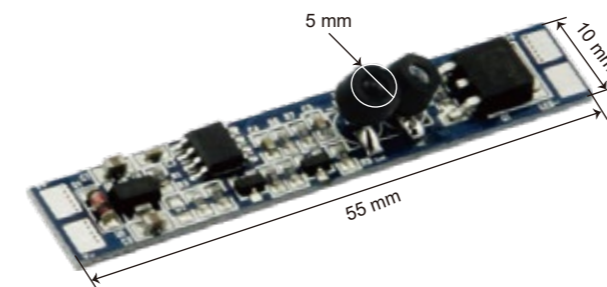

### Internal IR hand sensor switch: IR001

- 1, Input voltage: 12-24V DC.
- 2, Current: 8A max.
- 3, Power: 96W for 12V, and 192W for 24V.
- 4, Detection range:  $0.5\text{cm} \leq \text{detection range} \leq 10\text{cm}$ .
- 5, Automatically switch on/off when the hand pass over.

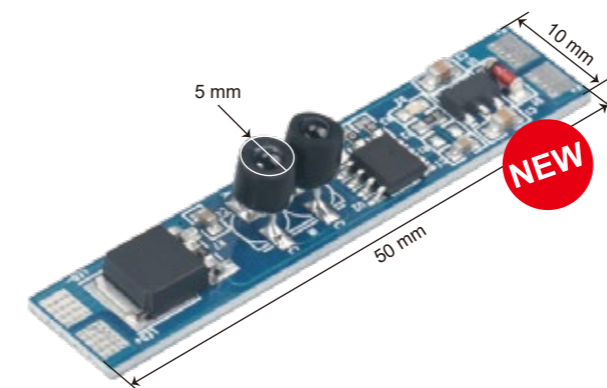

### IR hand sensor switch: EIR001D

- 1, Input voltage: 12-24V DC.
- 2, Current: 8A max.
- 3, Power: 96W for 12V, and 192W for 24V.
- 4, Detection range:  $0.5\text{cm} \leq \text{detection range} \leq 10\text{cm}$ .
- 5, Hold hand over the sensor for 3 seconds to dim from 1%~100%.
- 6, 12V-24V DC memory function.



## IR hand sensor switch: IR001D

- 1 , Input voltage: 12-24V DC.
- 2 , Current: 8A max.
- 3 , Power: 96W for 12V, and 192W for 24V.
- 4 , Detection range:  $0.5\text{cm} \leq \text{detection range} \leq 10\text{cm}$ .
- 5 , Hold hand over the sensor for 3 seconds to dim from 1%~100%.
- 6 , 12V-24V DC memory function.

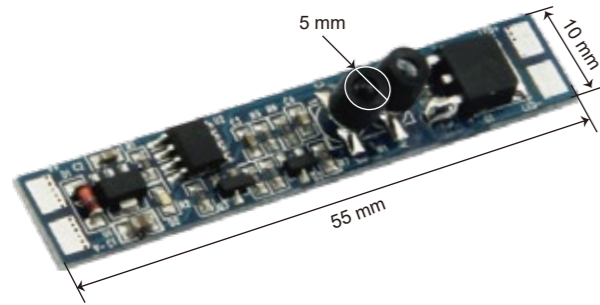

## External hand sensor: IR003

- 1 , Input voltage: 12-24V DC.
- 2 , Current: 4A max.
- 3 , Power: 48W for 12V, and 96W for 24V.
- 4 , Detection range:  $0.5\text{cm} \leq \text{detection range} \leq 10\text{cm}$ .
- 5 , Cable length: 15cm with dc plug.
- 6 , Material: aluminum housing.
- 7 , Automatically switch on/off when the hand pass over.

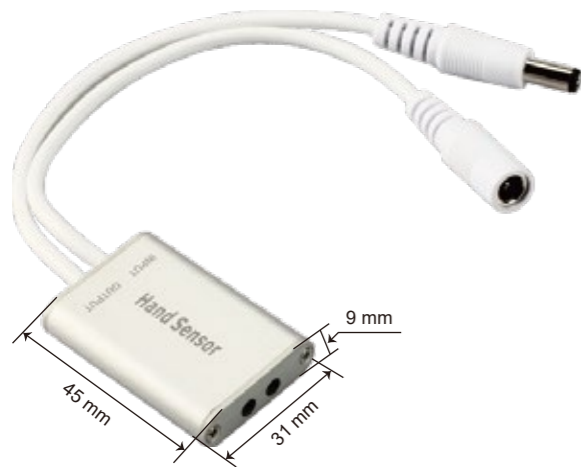

## Recessed hand sensor switch: IR005-H

- 1 , Input voltage: 12-24V DC.
- 2 , Current: 4A max.
- 3 , Power: 48W for 12V, and 96W for 24V.
- 4 , Detection range:  $0.5\text{cm} \leq \text{detection range} \leq 10\text{cm}$ .
- 5 , Automatically switch on/off when the hand pass over.
- 6 , Cable length: 1m with mini connector.



## Surface mounting hand sensor switch: IR006-H

- 1 , Input voltage: 12-24V DC.
- 2 , Current: 4A max.
- 3 , Power: 48W for 12V, and 96W for 24V.
- 4 , Detection range:  $0.5\text{cm} \leq \text{detection range} \leq 10\text{cm}$ .
- 5 , Input and output cable length: 1m (customized length can be ordered).
- 6 , Automatically switch on/off when the hand pass over.

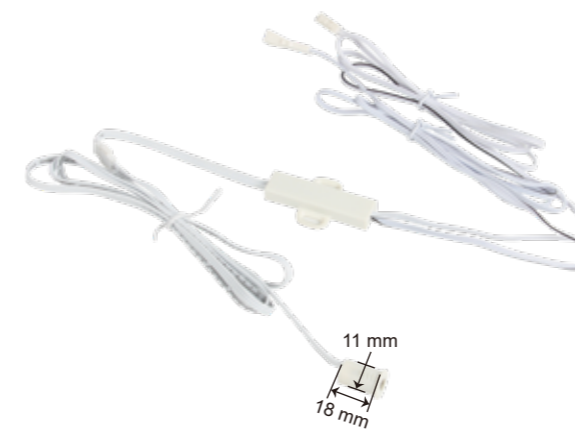

## Recessed hand sensor switch: IR008A-H

- 1 , Input voltage: 12-24V DC.
- 2 , Current: 4A max.
- 3 , Power: 48W for 12V, and 96W for 24V.
- 4 , Detection range:  $0.5\text{cm} \leq \text{detection range} \leq 10\text{cm}$ .
- 5 , Automatically switch on/off when the hand pass over.
- 6 , Input and output cable length: 1cm (cable length can be customized).
- 7 , LED sensor detector cable length: 1m (cable length can be customized).

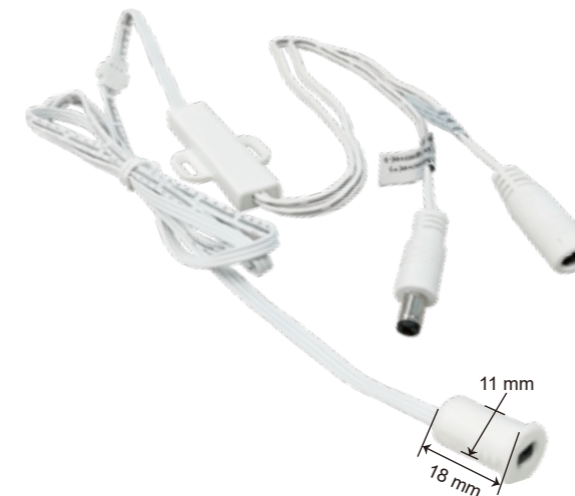

## Recessed hand sensor switch: IR008B-H

- 1 , Input voltage: 12-24V DC.
- 2 , Current: 4A max.
- 3 , Power: 48W for 12V, and 96W for 24V.
- 4 , Detection range:  $0.5\text{cm} \leq \text{detection range} \leq 10\text{cm}$ .
- 5 , Automatically switch on/off when the hand pass over.
- 6 , Input and output cable length: 25cm (cable length can be customized).
- 7 , LED sensor detector cable length: 1m (cable length can be customized).



## Surface mounting hand sensor switch: IR009A-H

- 1 , Input voltage: 12-24V DC.
- 2 , Current: 4A max.
- 3 , Power: 48W for 12V, and 96W for 24V.
- 4 , Detection range:  $0.5\text{cm} \leq \text{detection range} \leq 10\text{cm}$ .
- 5 , Automatically switch on/off when the hand pass over.
- 6 , Input and output cable length: 1cm(cable length can be customized).
- 7 , LED sensor detector cable length: 1m(cable length can be customized).



## Surface mounting hand sensor switch: IR009B-H

- 1 , Input voltage: 12-24V DC.
- 2 , Current: 4A max.
- 3 , Power: 48W for 12V, and 96W for 24V.
- 4 , Detection range:  $0.5\text{cm} \leq \text{detection range} \leq 10\text{cm}$ .
- 5 , Automatically switch on/off when the hand pass over.
- 6 , Input and output cable length: 25cm(cable length can be customized).
- 7 , LED sensor detector cable length: 1m(cable length can be customized).

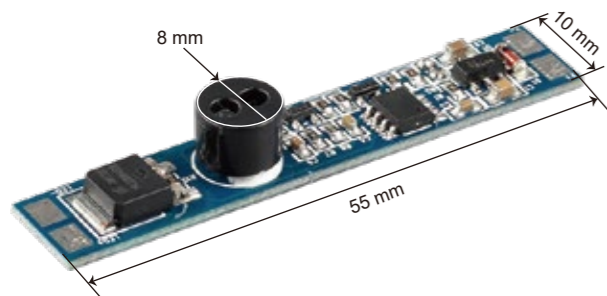

## IR hand sensor: IR012(Internal)

- 1 , Input voltage: 12-24V DC.
- 2 , Current: 8A max.
- 3 , Power: 96W for 12V, and 192W for 24V.
- 4 , Detection range:  $0.5\text{cm} \leq \text{detection range} \leq 10\text{cm}$ .
- 5 , Automatically switch on/off when the hand pass over.
- 6 , Dimension: 55\*10mm.

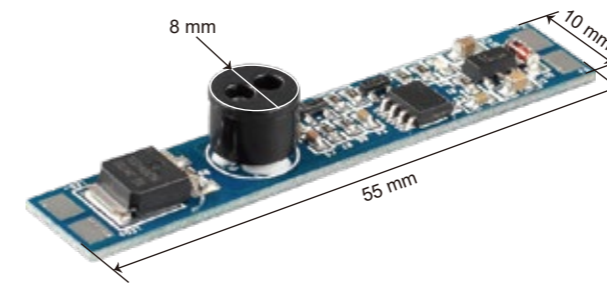

## IR hand sensor: IR012D Dimming+Memory

- 1 , Input voltage: 12-24V DC.
- 2 , Current: 8A max.
- 3 , Power: 96W for 12V, and 192W for 24V.
- 4 , Detection range:  $0.5\text{cm} \leq \text{detection range} \leq 10\text{cm}$ .
- 5 , Light will turn on/off when hand is passing over the sensor, dimmable when keeping covering. 12-24V memory function.
- 6 , Dimension: 55\*10mm.

# IR DOOR SENSOR

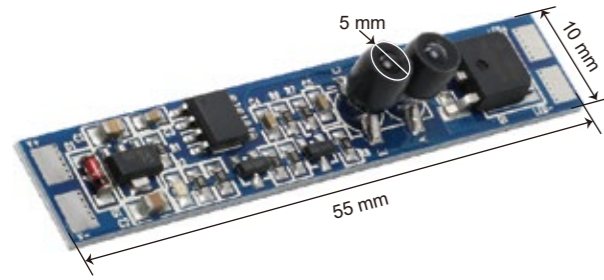

## IR door sensor switch: IR002

- 1 , Input voltage: 12-24V DC.
- 2 , Current: 8A max.
- 3 , Power: 96W for 12V, and 192W for 24V.
- 4 , Detection range: 0.5cm≤detection range≤10cm.
- 5 , Automatically switch on/off when open/close the door.



## External door sensor: IR004

- 1 , Input voltage: 12-24V DC.
- 2 , Current: 4A max.
- 3 , Power: 48W for 12V, and 96W for 24V.
- 4 , Detection range: 0.5cm≤detection range≤10cm.
- 5 , Cable length: 15cm with dc plug.
- 6 , Material: aluminum housing.
- 7 , Automatically switch on/off when open/close the door.



## Recessed door sensor switch: IR005-D

- 1 , Input voltage: 12-24V DC.
- 2 , Current: 4A max.
- 3 , Power: 48W for 12V, and 96W for 24V.
- 4 , Detection range: 0.5cm≤detection range≤10cm.
- 5 , Lights will be on/off when open/close the door.
- 6 , Cable length: 1m with mini connector.



## Surface mounting door sensor switch: IR006-D

- 1 , Input voltage: 12-24V DC.
- 2 , Current: 4A max.
- 3 , Power: 48W for 12V, and 96W for 24V.
- 4 , Detection range: 0.5cm≤detection range≤10cm.
- 5 , Lights will be on/off when open/close the door.
- 6 , Cable length: 1m with mini connector.

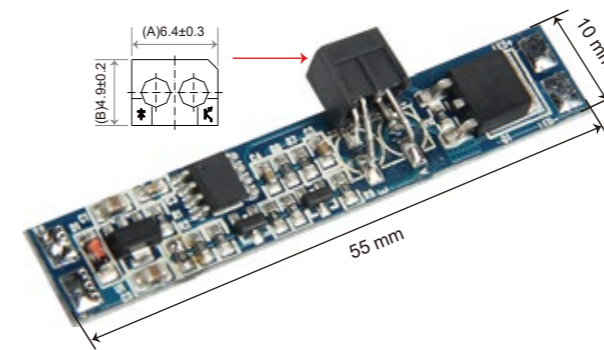

## Door Sensor IR007(Internal)

- 1 , Input Voltage: 12V-24V DC.
- 2 , Output Voltage: 12V-24V DC.
- 3 , Input Current: 8A max.
- 4 , Power: 96W for 12V, and 192W for 24V.
- 5 , Detection range: 0.5cm≤detection range≤10cm.
- 6 , Automatically switch on/off when open/close the door.
- 7 , Dimension: 55\*10mm.

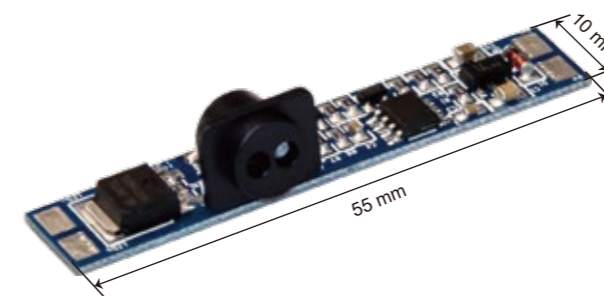

## IR door sensor switch: IR007-C

- 1 , Input voltage: 12-24V DC.
- 2 , Current: 8A max.
- 3 , Power: 96W for 12V, and 192W for 24V.
- 4 , Detection range: 0.5cm≤detection range≤10cm.
- 5 , Automatically switch on/off when open/close the door.
- 6 , Dimension: 55\*10mm.

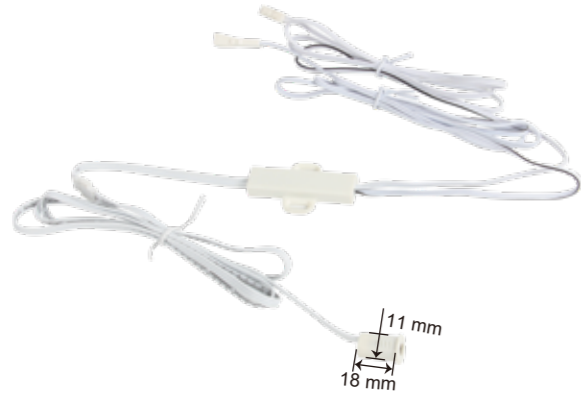

## Recessed door sensor switch: IR008A-D

- 1 , Input voltage: 12-24V DC.
- 2 , Current: 4A max.
- 3 , Power: 48W for 12V, and 96W for 24V.
- 4 , Detection range: 0.5cm≤detection range≤10cm.
- 5 , Automatically switch on/off when open/close the door.
- 6 , Input and output cable length: 1m(cable length can be customized).
- 7 , LED sensor detector cable length: 1m(cable length can be customized).



## Recessed door sensor switch: IR008B-D

- 1 , Input voltage: 12-24V DC.
- 2 , Current: 4A max.
- 3 , Power: 48W for 12V, and 96W for 24V.
- 4 , Detection range: 0.5cm≤detection range≤10cm.
- 5 , Automatically switch on/off when open/close the door.
- 6 , Input and output cable length: 25cm(cable length can be customized).
- 7 , LED sensor detector cable length: 1m(cable length can be customized).



## Surface mounting door sensor switch: IR009A-D

- 1 , Input voltage: 12-24V DC.
- 2 , Current: 4A max.
- 3 , Power: 48W for 12V, and 96W for 24V.
- 4 , Detection range: 0.5cm≤detection range≤10cm.
- 5 , Automatically switch on/off when open/close the door.
- 6 , Input and output cable length: 1cm(cable length can be customized).
- 7 , LED sensor detector cable length: 1m(cable length can be customized).

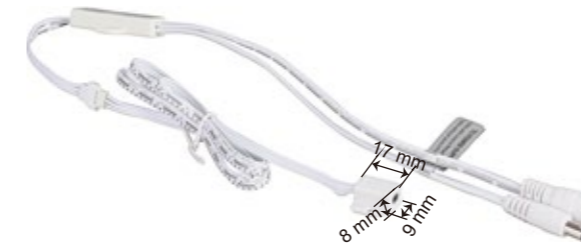

## Surface mounting door sensor switch: IR009B-D

- 1 , Input voltage: 12-24V DC.
- 2 , Current: 4A max.
- 3 , Power: 48W for 12V, and 96W for 24V.
- 4 , Detection range: 0.5cm≤detection range≤10cm.
- 5 , Automatically switch on/off when open/close the door.
- 6 , Input and output cable length: 25cm(cable length can be customized).
- 7 , LED sensor detector cable length: 1m(cable length can be customized).

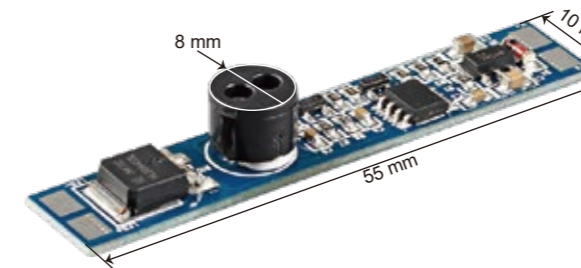

## IR door sensor: IR013(internal)

- 1 , Input voltage: 12-24V DC.
- 2 , Current: 8A max.
- 3 , Power: 96W for 12V, and 192W for 24V.
- 4 , Detection range: 0.5cm≤detection range≤10cm.
- 5 , Automatically switch on/off when open/close the door.
- 6 , Dimension: 55\*10mm.

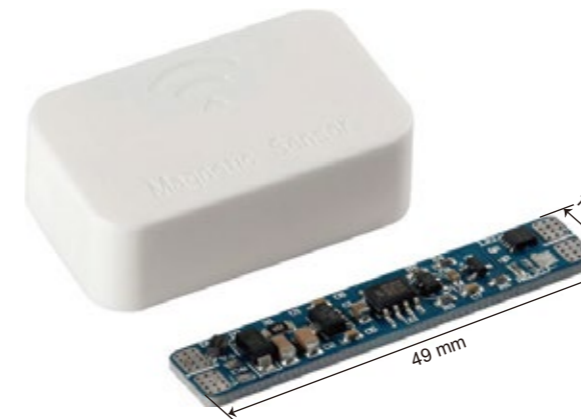

## Magnetic sensor switch: MC001

- 1 , Input voltage: 12-24V DC.
- 2 , Current: 3A max.
- 3 , Detection range: ≤1.5cm.
- 4 , Turn on/off the light when the magnet leaves or approaches.
- 5 , With brightness buffer function.

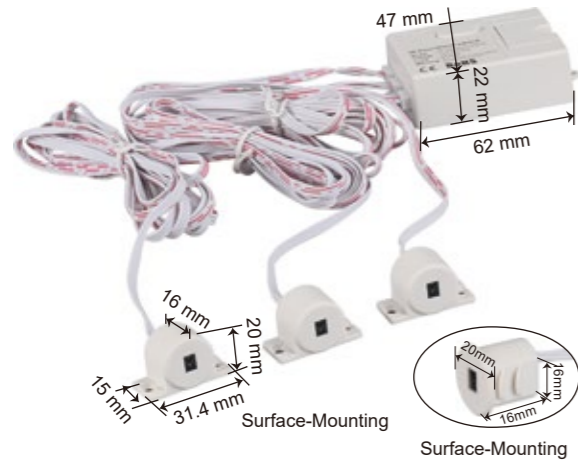

## IR door & hand sensor switch

- 1, Input voltage: 12-24V DC.
- 2, Current: 8A max.
- 3, Power: 96W for 12V, and 192W for 24V.
- 4, Detection range:  $0.5\text{cm} \leq \text{detection range} \leq 10\text{cm}$ .
- 5, Mode can be changed manually:  
door mode: turn on the light when the door is open.  
hand mode: turn on the light when the hand is passing over.
- 6, Workable with 1/2/3 detectors.

## Recessed door & hand sensor switch: IR010

- 1, Input voltage: 12-24V DC.
- 2, Current: 4A max.
- 3, Power: 48W for 12V, and 96W for 24V.
- 4, Detection range:  $0.5\text{cm} \leq \text{detection range} \leq 10\text{cm}$ .
- 5, Mode can be changed manually:  
door mode: turn on the light when the door is open.  
hand mode: turn on the light when the hand is passing over.
- 6, Input and output cable length: 25cm(cable length can be customized).
- 7, LED sensor detector cable length: 1m(cable length can be customized).

## Surface mounting door & hand sensor switch: IR011

- 1, Input voltage: 12-24V DC.
- 2, Current: 4A max.
- 3, Detection range:  $0.5\text{cm} \leq \text{detection range} \leq 10\text{cm}$ .
- 4, Power: 48W for 12V, and 96W for 24V.
- 5, Automatically switch on/off when open/close the door.
- 6, Mode can be changed manually:  
door mode: turn on the light when the door is open.  
hand mode: turn on the light when the hand is passing over.
- 7, Input and output cable length: 1m(cable length can be customized).
- 8, LED sensor detector cable length: 1m(cable length can be customized).



## Recessed Mounted Door/Hand Sensor IR010N

Fixed two detectors to make the sensor works.

- 1, Input voltage: 12-24V DC.
- 2, Current: 4A max.
- 3, Detection range:  $0.5\text{cm} \leq \text{detection range} \leq 10\text{cm}$ .
- 4, Hand Mode: the LED light will switch on when hand pass over the detectors within the 10cm detection range. the LED light will switch off when hand pass over the detectors within the 10cm detection range again.
- 5, Door Mode: when there are target objects in the detecting range of both of the two detectors, the LED light switches off. when there are not target objects in the detecting range of one of the detectors, the LED light switches on.



## Surface Mounted Door/Hand Sensor IR011N

Fixed two detectors to make the sensor works.

- 1, Input voltage: 12-24V DC.
- 2, Current: 4A max.
- 3, Detection range:  $0.5\text{cm} \leq \text{detection range} \leq 10\text{cm}$ .
- 4, Hand Mode: the LED light will switch on when hand pass over the detectors within the 10cm detection range. the LED light will switch off when hand pass over the detectors within the 10cm detection range again.
- 5, Door Mode: when there are target objects in the detecting range of both of the two detectors, the LED light switches off. when there are not target objects in the detecting range of one of the detectors, the LED light switches on.



## Recessed or surface mounted door/hand senso: IR015

- 1, Input voltage: 12-24V DC.
- 2, Output Voltage: 12V-24V DC.
- 3, Current: 2A max.
- 4, Detection range:  $0.5\text{cm} \leq \text{detection range} \leq 10\text{cm}$ .
- 5, Load croud: Load around 24W for 12V, 48W for 24V.



## IR HAND & DOOR SENSOR

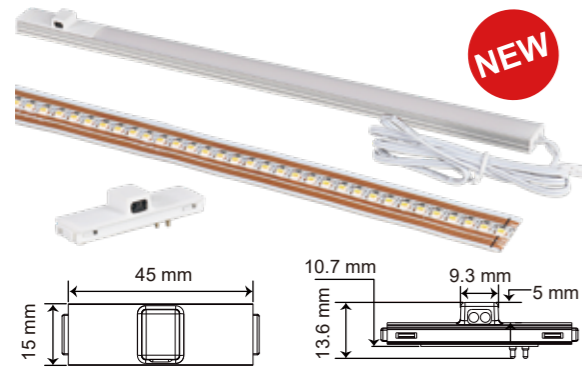

### Free move door sensor: IR016

Lights will be on/off when open/close the door.

- 1 , Input voltage: 12-24V DC.
- 2 , Output Voltage: 12V-24V DC.
- 3 , Current: 2A max.
- 4 , Detection range: 0.5cm≤detection range≤10cm.
- 5 , Load croud: Load around 24W for 12V, 48W for 24V.
- 6 , Color: white/Black.

## MIRROR SENSOR SWITCH

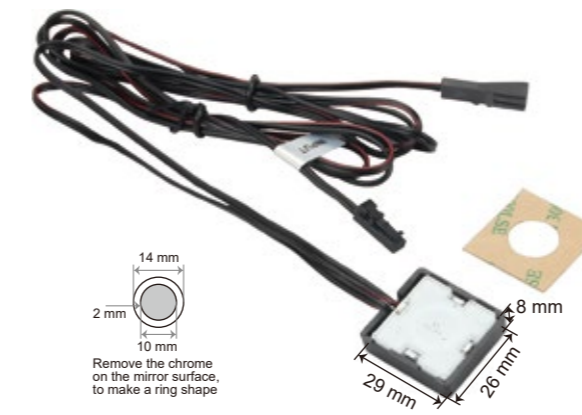

### Touch dimmer for mirror: TD009

Touch switch dimming+memory function

- 1 , Input voltage: 12-24V DC.
- 2 , Current: 4A max.
- 3 , Power: 48W for 12V, and 96W for 24V.
- 4 , Cable length: 1m with mini connector.
- 5 , Quick touch: switch on/off; long touch: dimming.

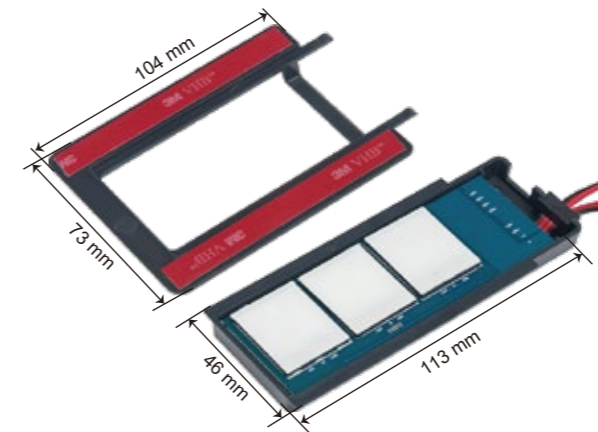

### Mirror touch dimmer: TD012B

- 1 , Input voltage: 12-24V DC.
- 2 , Current: 4A max.
- 3 , Power: 48W for 12V, and 96W for 24V.
- 4 , Mirror touch switch on/off+dimming+memory function.
- 5 , Input and output cable length: 200mm (customized length can be ordered).



### Mirror sensor switch: MSS001

Turn on/off the light when hand pass over the mirror within 10cm.

- 1 , Input voltage: 12-24V DC.
- 2 , Loading power: 4A max.
- 3 , Hold the hand over the sensor more than 1 second, adjusting the brightness from 3% to 100%.
- 4 , With 0V memory function.
- 5 , Load around 48W for 12V, and 96W for 24V.
- 6 , Input and output cable length: 1m(customized length can be ordered).

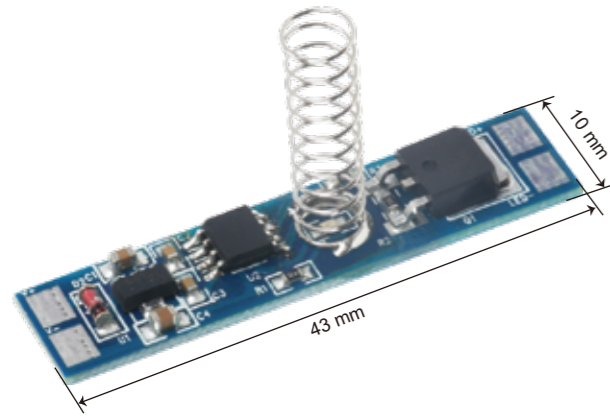

### Touch dimmer: TD001

Touch switch on/off function

- 1 , Input voltage: 12-24V DC.
- 2 , Current: 8A max.
- 3 ,Power: 96W for 12V, and 192W for 24V.
- 4 , Quick touch: switch on/off.

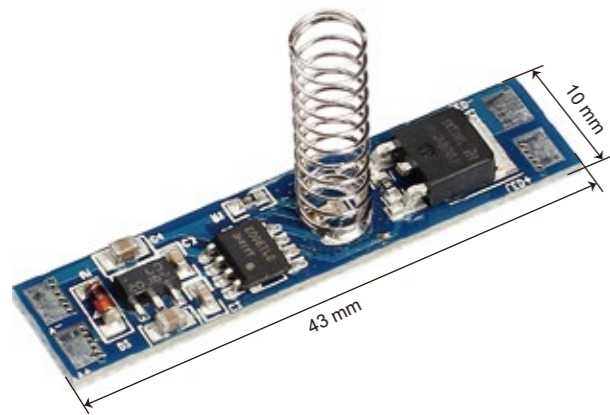

### Touch dimmer: TD002

Touch switch on/off with dimming function

- 1 , Input voltage: 12-24V DC.
- 2 , Current: 8A max.
- 3 ,Power: 96W for 12V, and 192W for 24V.
- 4 , Quick touch: switch on/off.
- 5 , Long touch: dimming.

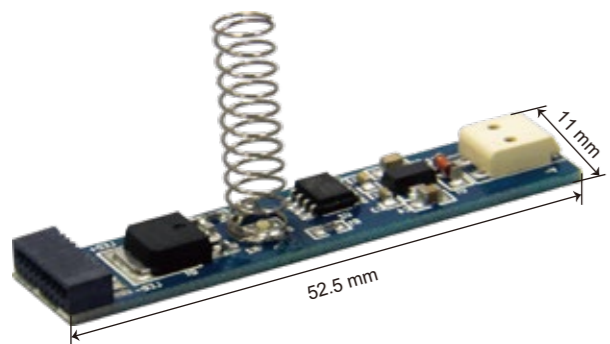

### Touch dimmer: TD002-TM

Touch switch on/off with dimming function.

- 1 , Input voltage: 12-24V DC.
- 2 , Output voltage: 12V-24V DC.
- 3 , Current: 3A max.
- 4 , Input wire: 26~20AWG.
- 5 , Recommended stripping length: 6-7mm.
- 6 , Connecting led strip thickness: 0.4-0.6mm.
- 7 , Connecting led strip width: 8-10mm.
- 8 , Height of spring 20mm(cutttable).
- 9 , Load around 36W for 12V, and 72W for 24V.

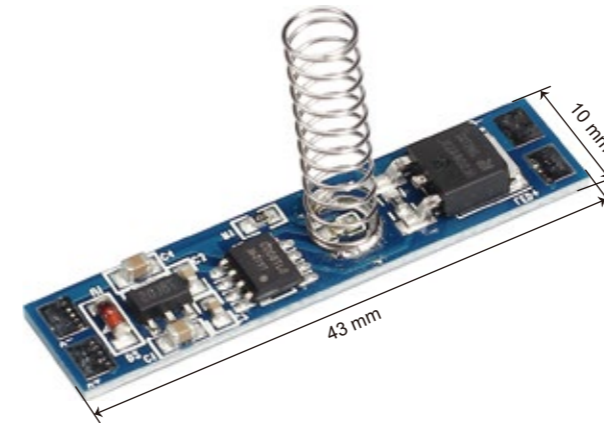

### Touch dimmer: TD003

Touch switch on/off with dimming function.

- 1 , Input voltage: 12-24V DC.
- 2 , Current: 8A max.
- 3 , Power: 96W for 12V, and 192W for 24V.
- 4 , Quick touch: switch on/off ; long touch: dimming.
- 5 , 12V-24V DC memory function.

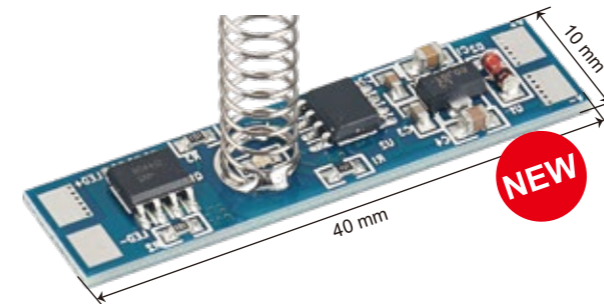

### Touch dimmer: ETD003

Touch switch on/off with dimming function.

- 1 , Input voltage: 12-24V DC.
- 2 , Current: 4A max.
- 3 , Power: 48W for 12V, and 96W for 24V.
- 4 , Quick touch: switch on/off ; long touch: dimming.
- 5 , 12V-24V DC. memory function.

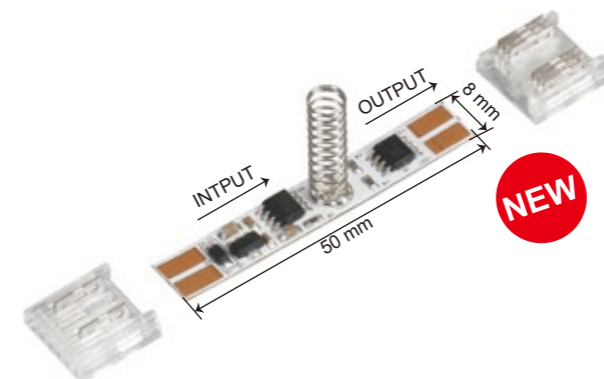

### CCT Touch dimmer switch: FTD003

Touch switch on/off with dimming function.

- 1 , Input voltage: 12-24V DC.
- 2 , Output voltage: 12V-24V DC.
- 3 , Input wire outer diameter: 1.9mm max.
- 4 , Input Current: 3A.
- 5 , Height of spring: 20mm.
- 6 , Load around: 48W for 12V, and 96W for 24V.

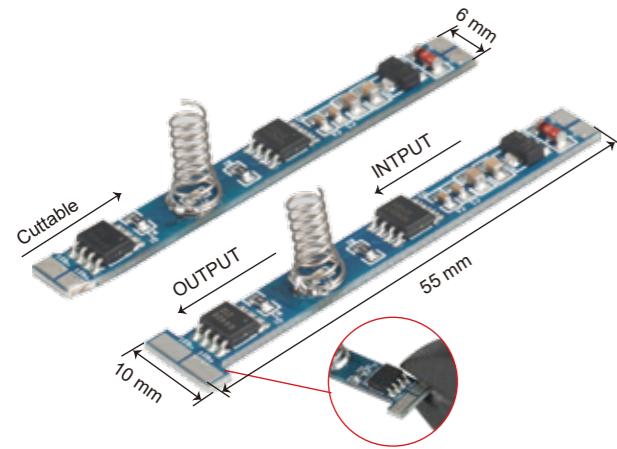

## Touch dimmer: MTD003

Touch switch on/off with dimming function.

- 1, Input voltage: 12-24V DC.
- 2, Current: 3A max.
- 3, Height of Spring: 20mm.
- 4, Power: 48W for 12V, and 96W for 24V.
- 5, LED Strip Width : 4-12mm.
- 6, Power off (0v) and 12V-24V DC memory function.

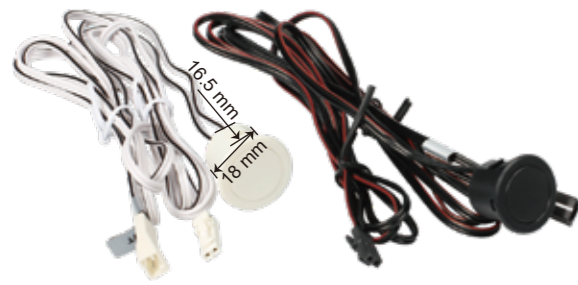

## Touch dimmer: TD004A

Touch switch on/off with dimming function.

- 1, Input voltage: 12-24V DC.
- 2, Current: 4A max.
- 3, Power: 48W for 12V, and 96W for 24V.
- 4, Cable length: 1m with mini connector.
- 5, Quick touch: switch on/off ; long touch: dimming.



## Touch dimmer: TD004B

Touch switch on/off with dimming function.

- 1, Input voltage: 12-24V DC.
- 2, Current: 4A max.
- 3, Power: 48W for 12V, and 96W for 24V.
- 4, Cable length: 15cm with dc 5.5x2.1 plug.
- 5, Quick touch: switch on/off ; long touch: dimming.



## Touch dimmer: TD004AM

Touch switch on/off with dimming and memory function.

- 1, Input voltage: 12-24V DC.
- 2, Current: 4A max.
- 3, Power: 48W for 12V, and 96W for 24V.
- 4, Cable length: 1m with mini connector.
- 5, Quick touch: switch on/off ; long touch: dimming.
- 6, 12V-24VDC memory function.



## Touch dimmer: TD004BM

Touch switch on/off with dimming and memory function.

- 1, Input voltage: 12-24V DC.
- 2, Current: 4A max.
- 3, Power: 48W for 12V, and 96W for 24V.
- 4, Cable length: 15cm with dc 5.5x2.1 plug.
- 5, Quick touch: switch on/off ; long touch: dimming.
- 6, 12V-24VDC memory function.



## External touch dimmer: TD005

Touch switch on/off with dimming function.

- 1, Input voltage: 12-24V DC.
- 2, Current: 4A max.
- 3, Power: 48W for 12V, and 96W for 24V.
- 4, Cable length: 15cm with dc 5.5x2.1 plug.
- 5, Quick touch: switch on/off ; long touch: dimming.



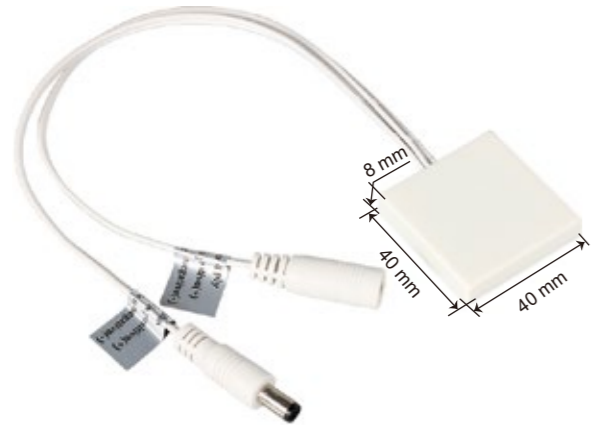

## External touch dimmer for panel: TD006

Touch switch on/off with dimming function+memory.

- 1 , Input voltage: 12-24V DC.
- 2 , Current: 4A max.
- 3 , Power: 48W for 12V, and 96W for 24V.
- 4 , Cable length: 25cm with dc 5.5x2.1 plug.
- 5 , Touch wood/glass panel, max 25mm.
- 6 , Quick touch: switch on/off ; long touch: dimming.



## Touch dimmer with LED: TD008

Touch switch on/off with dimming and memory function .

- 1 , Input voltage: 12-24V DC.
- 2 , Current: 4A max.
- 3 , Power: 48W for 12V, and 96 W for 24V.
- 4 , Cable length: 1m with mini connector.
- 5 , Quick touch: switch on/off; long touch: dimming.
- 6 , 12V-24V DC memory function.

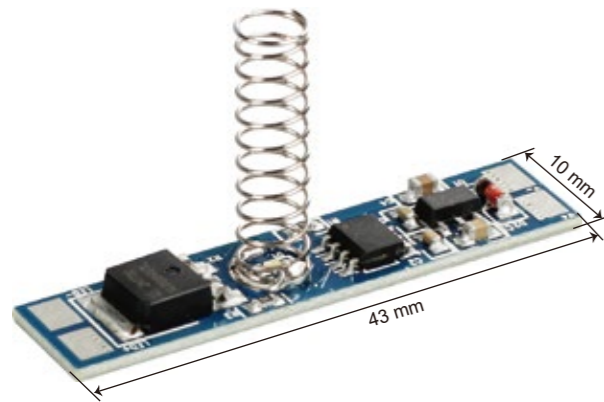

## Touch dimmer: TD007

Touch switch on/off with dimming and 0V memory function.

- 1 , Input voltage: 12-24V DC.
- 2 , Current: 8A max.
- 3 , Power: 96W for 12V, and 192W for 24V.
- 4 , Quick touch: switch on/off ; long touch: dimming.
- 5 , Power off (0V) and 12V-24V DC memory function.

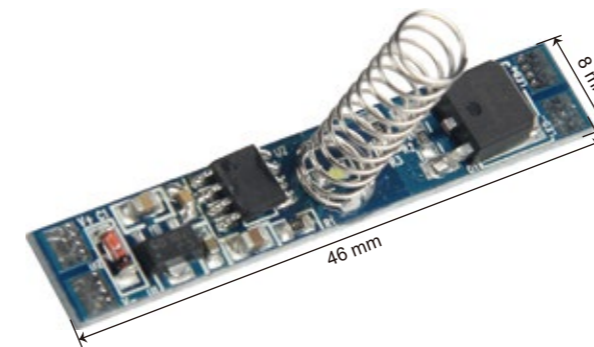

## Memory touch switch dimmer: TD010

Touch on/off switch with dimming and memory function.

- 1 , Input voltage: 12-24V DC.
- 2 , Current: 8A max.
- 3 , Power: 96W for 12V, and 196W for 24V.
- 4 , Quick touch: switch on/off; long touch: dimming.
- 5 , 12V-24V DC memory function.
- 6 , Brightness buffer in 3 seconds.

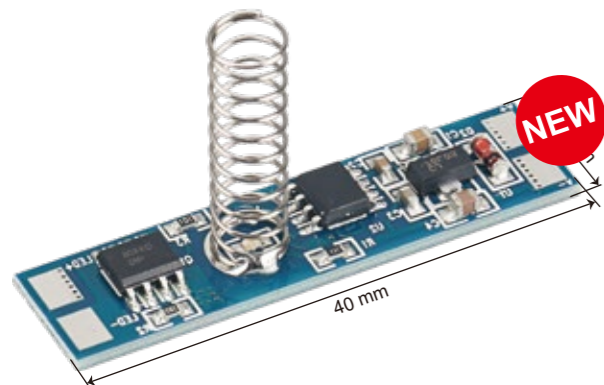

## Touch dimmer: ETD007

Touch switch on/off with dimming and 0V memory function.

- 1 , Input voltage: 12-24V DC.
- 2 , Current: 4A max.
- 3 , Power: 48W for 12V, and 96W for 24V.
- 4 , Quick touch: switch on/off ; long touch: dimming.
- 5 , Power off (0V) and 12V-24V DC memory function.

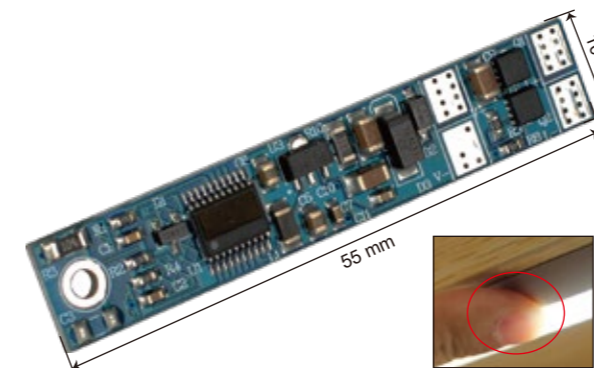

## Touch-aluminum profile LED sensor switch: TD011

- 1 , Input voltage: 12-24V DC.
- 2 , Current: 3A max.
- 3 , Power: 36W for 12V, and 72W for 24V.
- 4 , Quick touch: switch on/off ; long touch: dimming.
- 5 , 0V (power off) memory function.
- 6 , Accessory: pm2\*3mm screw\*1 pcs.

## TOUCH DIMMER

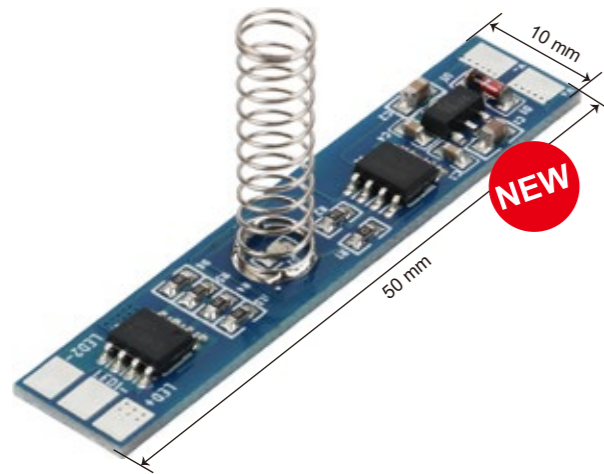

### CCT Touch dimmer switch: TD015

Touch to change color temperature and dimming and 0V memory.

- 1 , Input voltage: 12-24V DC.
- 2 , Output voltage: 12V-24V DC.
- 3 , Input current: single channel: max. 4A, total max. 6A.
- 4 , Height of spring: 20mm.
- 5 , Load around: 72W for 12V and 144W for 24V.

## BUTTON SWITCH

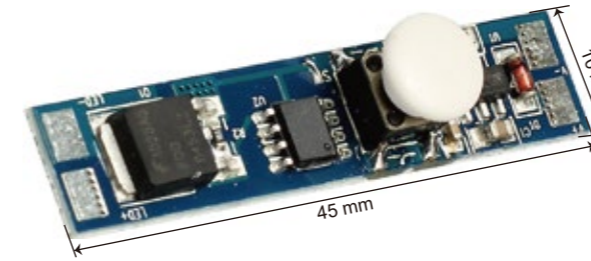

### Micro button switch: BS001

Button switch on/off with dimming and memory function.

- 1 , Input voltage: 12-24V DC.
- 2 , Current: 8A max.
- 3 , Power: 96W for 12V, and 192W for 24V.
- 4 , Quick press: switch on/off; long press: dimming.
- 5 , 12V-24V DC memory function.



### Micro button switch: BS002

Operation: on/off+dimming function and 0V memory.

- 1 , Input voltage: 12-24V DC.
- 2 , Output voltage: 12V-24V DC.
- 3 , Input current: 4A max.
- 4 , Input and output cable length: 30cm (length can be ordered).
- 5 , Load around: 48W for 12V, and 96W for 24V.
- 6 , Waterproof: IP65.



### Mini dimmer with CCT function: BS003-1

Operation: press, press twice, rotate.

- 1 , Input voltage: 12-24V DC.
- 2 , Input current: 3A/CH.
- 3 , IP rate: IP65.
- 4 , Dimming grade: 20.
- 5 , CCT grade: 21.
- 6 , Color: cold white+warm white.
- 6 , Rotate: Dimming or changing color temperature.

## BUTTON SWITCH



### Mini dimmer with CCT function: BS003-2

Operation: press, press twice, rotate

- 1 , Input voltage: 12-24V DC.
- 2 , Input current: 3A/CH.
- 3 , IP rate: IP65.
- 4 , Dimming grade: 10.
- 5 , CCT grade: 21.
- 6 , Color: cold white+warm white.

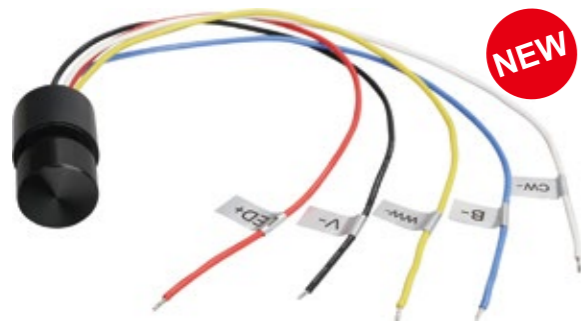

### Mini RGB controller button switch: BS004

Operation: press, press twice, press it 3 times, rotate

- 1 , Input voltage: 12-24V DC.
- 2 , Input current: 3A/CH.
- 3 , IP rate: IP65.
- 4 , Dimming grade: 20.
- 5 , CCT grade: 61.
- 6 , Color: RGB.

## WIRELESS SENSOR



### Wireless sensor: WS001 Series

The input and output voltage of WS001-IRE, 12-24V.  
The maximum current: 6A.

- 1 , The working voltage WS001-RE: 12-24V DC.
- 2 , WS001-DOOR WS001-2DOOR WS001-PIR WS001-TD  
Charging voltage: 5V.
- 3 , Wireless control distance: 10M.
- 4 , Size: 45\*45\*13mm.
- 5 , Working temperature: -20°C-40°C.
- 6 , Waterproof level: IP20.
- 7 , Service life: 50,000 hours.

#### Application scenarios:

- 1 , Widely used in hall cabinets, display cabinets, bookcases, cupboards, wardrobes, etc.
- 2 , Intelligent sensing is convenient, fast, exquisite in appearance, easy to install and use.
- 3 , Intelligent home experience, enjoy a better life.

#### 1. Wireless sensor function introduction:

- Touch wireless sensor switch: lightly touch the touch area to switch the light, long press the touch area to dim the light by 10-100%.
- PIR wireless sensor switch: When someone passes by, the light will turn on, and it will automatically turn off in about 30 seconds.
- Door sensor wireless sensor switch: Remotely turn off the lights when a magnet is detected, turn on the lights remotely when no magnet is detected.
- When the receiver receives multiple remote control command signals from the combined wireless remote control, the command signal from the last remote control is used to execute the working state.

#### 2. Features:

- For the constant voltage normal power supply, the independent receiver WS001-IRE uses a 2P(black and white wires) interface input/output voltage, to connect with the power supply and LED strips.
- The receiver WS001-RE uses a 3P interface input/output voltage of 12-24Vdc, and the output power is equal to the power supply.
- It is fixed magnetically, which is convenient and fast.
- Ultra-low standby power consumption, lithium battery can be used for more than one year.
- This product uses 2.4G wireless transmission method.
- The switch machine adopts advanced soft start technology.
- Advanced under-voltage protection. When the wireless sensor switch red LED flashes, it indicates that the battery power is insufficient and needs to be charged in time.
- Up to 7 wireless remote control switch combinations add unlimited possibilities for applications.

## Wireless sensor: WS002 Series



### 1 . Product Parameter

Model	WS002-TD	WS002-PIR	WS002-DOOR/DOOR2	WS002-RE	WS002-IRE
Communication Distance	< 15 meters				
Carrier Frequency	433.92 MHz				
Transmitting Power	+10dBm			—	
Receiving Sensitivity	—			-109dBm	
Input Voltage	DC5V			DC12-24V	
Load Current	—			6A MAX	
Matching Time	Each pair matches successfully in 6 seconds, the time will automatically continue				
Maximum Number of Pairings	—			Eight, in first-in, first-out order	
Tuning Time	—			3 seconds (With WS002-TD supports dimming only)	
Time Delay Time	—			30 seconds (With WS002-PIR support only)	
Magnetic Sensing Distance	—		1-1.5CM	—	
Sensing Distance	—	3 meters	—		



# PIR MOTION SENSOR FOR RUNNING WATER STEP LIGHT SYSTEM

## STAR HIGHT CONTROLLER SL001

### FEATURES

- 1, Each Stair light controller with 2 PIR sensor.
- 2, Input& Output Voltage: 12-24V DC.
- 3, Current: 3A Max. For main controller.
- 4, PIR sensor detective distance: 1.5-2 meter(each).
- 5, Function: The steplights will turn on step by step when people move into either PIR sensor detective range. The step lights will turn off step by step when people leave the PIR sensor detective range.
- 6, Adjustable options: 10 Steps light brightness adjustakle, Flowing speed 10 steps, Lights quantity 2-500pcs optional, Delay lighting time 0.5-10 minutes adjustable.



### DIMENSION

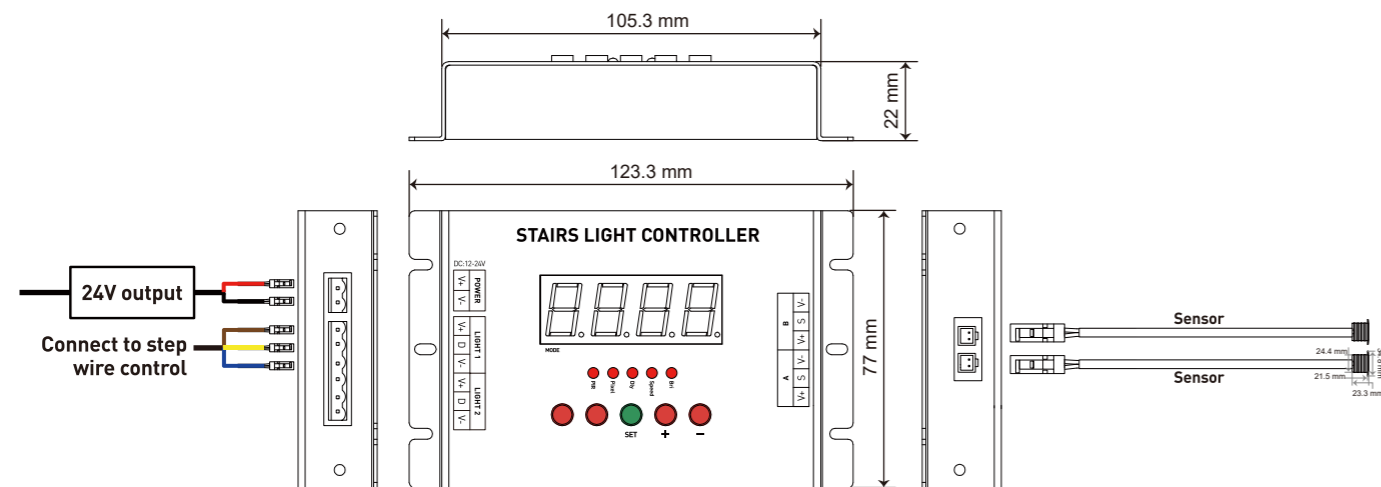

### CONTROLLER WIRING DIAGRAM

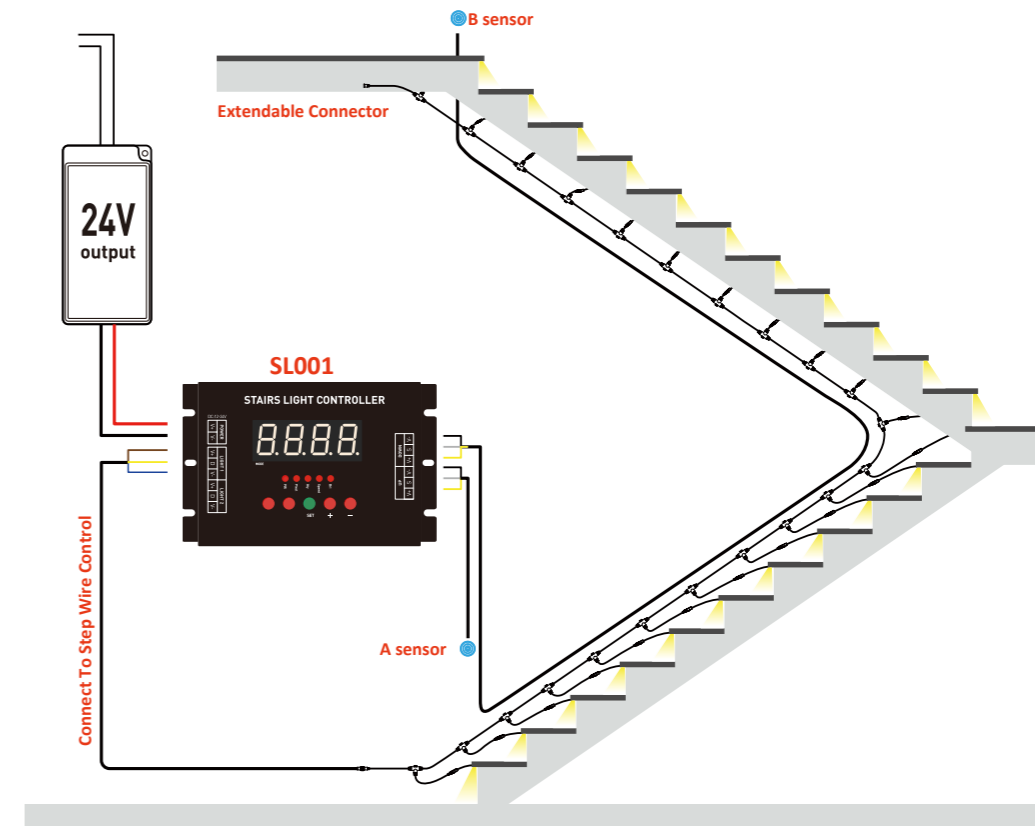



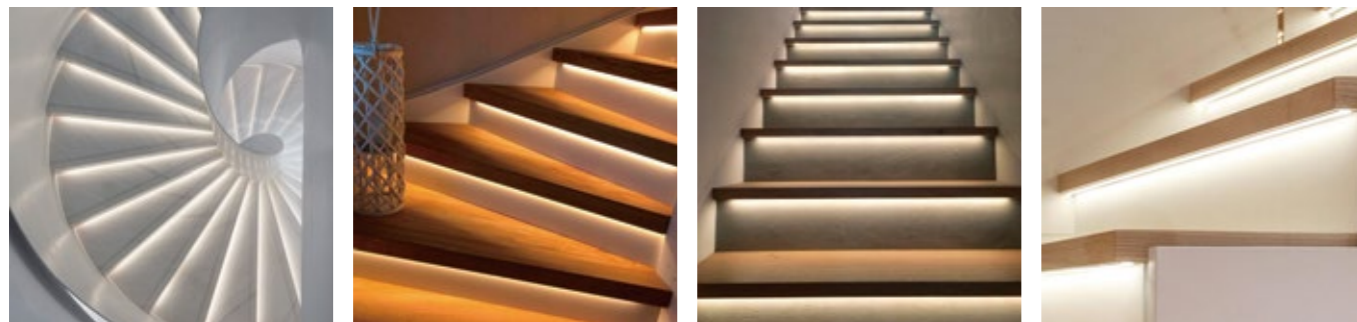

### SCENES TO BE USED



### STANDARD ACCESSORIES



 SET  Adjustable Parameters	 (Brightness)	1-10	Increased by 10%.
	 (Speed)	1-10	The larger number is, the longer interval time of light-on or light-off between 2 contiguous stairs is.
	 (Pixels)	2-500	Determine the controllable number of stair lights.
	 (Delay)	1-10	10-100 seconds.

# PIR MOTION SENSOR FOR RUNNING WATER STEP LIGHT SYSTEM

## STAR HIGHT CONTROLLER SL002

### FEATURES

- 1, Each Stair light controller with 2 PIR sensor.
- 2, Input& Output Voltage: 12-24V DC.
- 3, Current: 3A Max. For main controller.
- 4, PIR sensor detective distance: 1.5-2 meter(each).
- 5, CCT color 2700-6500K.
- 6, Function: The steplights will turn on step by step when people move into either PIR sensor detective range. The step lights will turn off step by step when people leave the PIR sensor detective range.
- 7, Adjustable options: 10 Steps light brightness adjustable, Flowing speed 10 steps, Lights quantity 2-500pcs optional, Delay lighting time 0.5-10 minutes adjustable, CCT color.



### CONTROLLER WIRING DIAGRAM

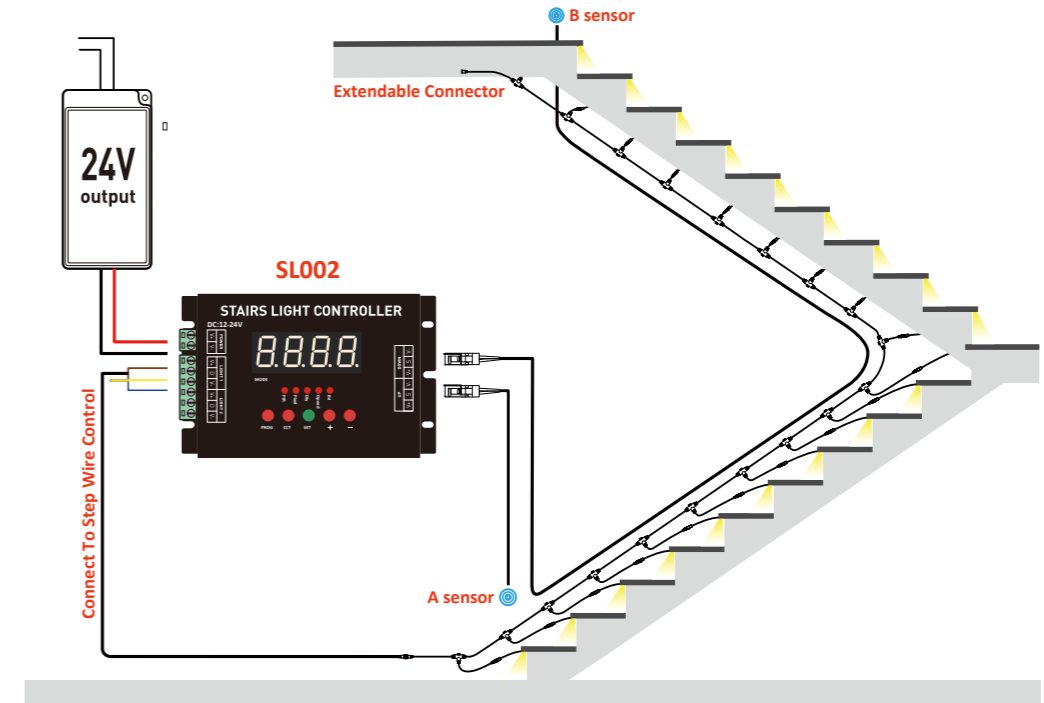

 <b>Adjustable Parameters</b>	 <b>(Brightness)</b>	1-10	The brightness of the light increases by 10%, the higher the value the brighter the light.
	 <b>(Speed)</b>	1-10	The flow speed of the light. The higher the value, the slower the flow speed of the light.
	 <b>(Pixels)</b>	2-500	Determines the number of step lights that can be controlled.
	 <b>(Delay)</b>	1-10	1. Lighting control duration range :1-100 seconds. 2. eg. 1 is 10 seconds, 2 is 20 seconds, 10 is 100 seconds.
	 <b>(Model)</b>	1-3	1. Flow in/out (flowing effect). 2. Overall fade in/fade out. 3. Individually fade in/fade out + flow in/out.

<b>2700-6500K</b> (color temperature)	10 levels	380K changes in each level gradually.(only for reference)
--	-----------	---

### SCENES TO BE USED

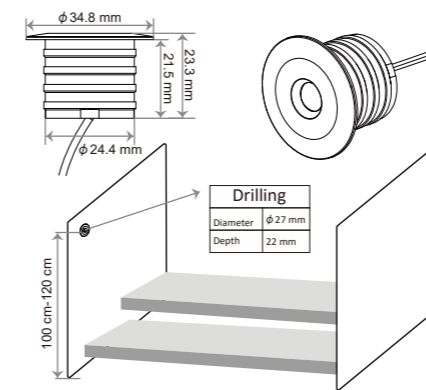
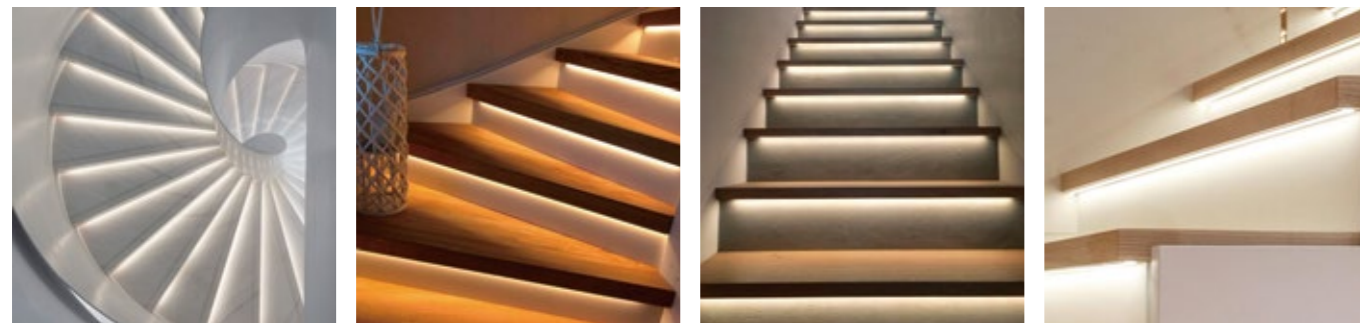

The sensor is suggested to be installed at a height of 100cm-120cm from the ground.



### STANDARD ACCESSORIES

