



[www.surmountor.com](http://www.surmountor.com)

+86-755-27926119/27926326    sales@surmountor.com

[www.surmountor.com](http://www.surmountor.com) / [www.sur-led.com](http://www.sur-led.com) / [www.ledstrip.cc](http://www.ledstrip.cc)

4/F, No.2 Factory Building, Dayang, No.4 Tangwei Industrial Avenue,  
Fuyong Street, Bao'an, Shenzhen, China

# 2024-2025

Neon led strip light/ 360° Round silicone neon light

Rectangle silicone neon light

## SILICONE NEON LIGHT

► ONE-STOP SERVICE

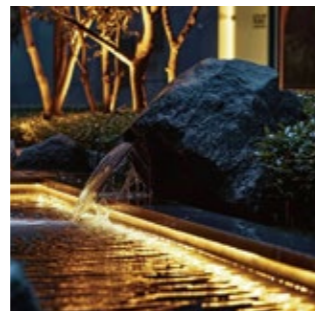
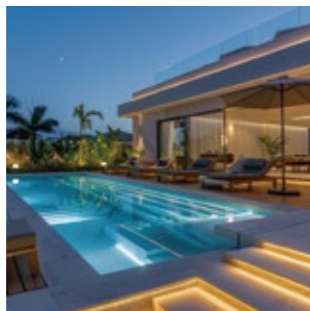
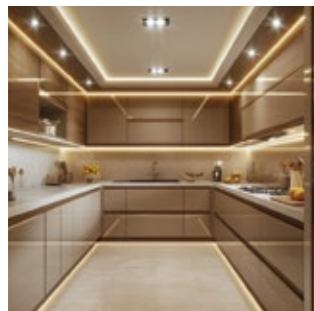
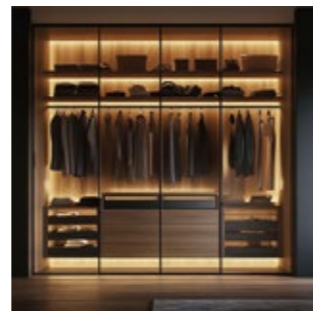
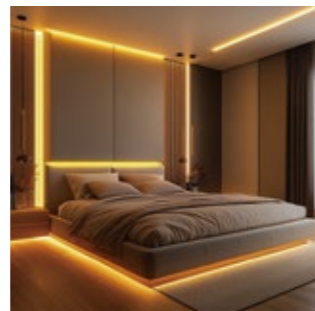
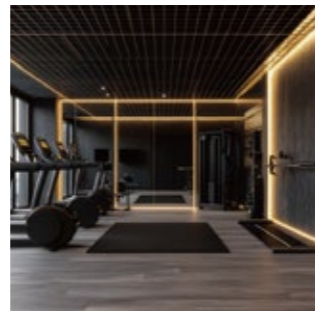
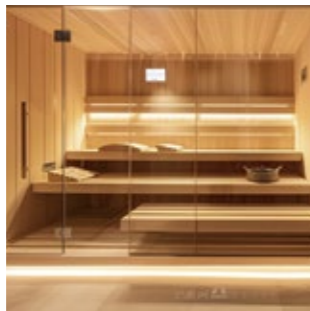
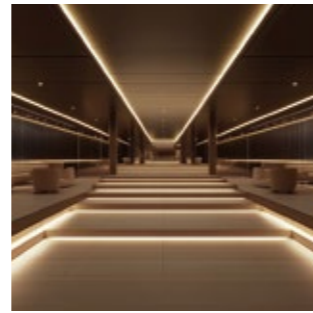
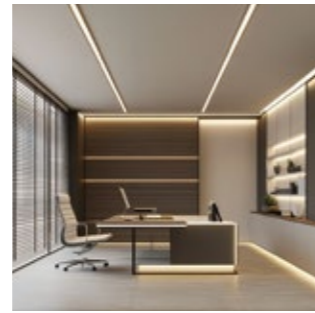
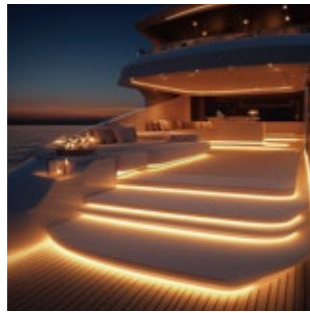
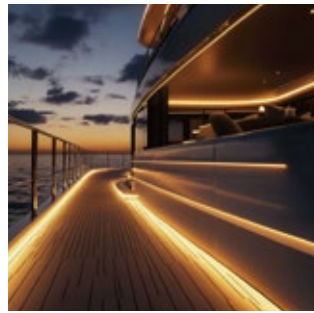

# TABLE OF CONTENTS

## About surmountor

Company overview	01-02
Main markets distribution	03-04

## Neon silicone tube

Neon silicone tube sizes	05-08
Black Neon Strip Light	09-12
Recessed Neon	13-18
3D Bend	19-22
Side Bend	23-32
Top Bend	33-42
360° Neon	43-52
Rectangle Neon Silicone Tube	53-64
Rectangle Neon Silicone Cover	65-70

# ABOUT OUR COMPANY



## We have an excellent team!

Our energetic and creative sales team understand customers' demands deeply and solve problems promptly. Every customer will be concerned and respected seriously, patiently, responsibly from enquiry-design-sampling-order-production-export-after sales service. Based on all our efforts, we attained great achievements and progress in the past 10 years, and also help our customers to expand their markets by constantly developing new products.

## Our strength and pursuit!

Our main strength is equipped with professional engineers, can provide customers with customized lighting solutions and win the market with clients together. Our goal is to build long term win-win relationship with our customers.



## We are professional manufacturer!

Surmountor Lighting Co.,LTD was founded in 2011, and has been diligently devoted in the LED lighting industry. With over 10 years experience, We are specialized in LED LED Neon Flex,Linear Lighting, LED Flexible Strip, LED Sensor Switches and LED Aluminum Profile, . And our products are widely used in outdoor or indoor lighting, hotel lighting, office lighting, shop lighting, kitchen lighting, etc.

Our factory is over 8000m<sup>2</sup>, with more than 100 employees. What's more, with the aim to be continuously competitive, our company is equipped with 10 professional R&D staffs. Our factory production monthly capacity reach more than 120,000 meters of flexible LED strips, 150,000 meters LED profiles, 100,000 pieces sensor switches, 36000 meters of neon light and so on.



## One-stop production and Continuous innovation!

With wide range led products line, we concentrate on offering one stop and one package service. To fulfil our worldwide partners different needs, our R&D departments always committed to continuously creating and innovating new products. In 2017, we developed LED Neon Lights. All of our neon flex products are of matte-finished texture, which helps feeling elegant and of higher quality level.

## We have ISO quality control System!

Our LED products are quality oriented and have passed a series of certifications, including CE, RoHS, UL, ISO9001:2015 management system, etc. We are committed to continuously providing our customers with high performance and reliable quality products. By offering competitive price, stable quality, timely delivery and good service, we gained good reputation among our customers all over the world, such as Europe, North America, Latin America, Australia, Middle East and Southeast Asia



## MAIN MARKETS DISTRIBUTION

Based on excellent quality and dedicated service, Surmountor is highly recognized and favored by foreign customers, enjoys a high reputation and fame in overseas markets, and has become one of the global consumers' reliable led brands. Products are exported to Europe, North America, Latin America, Australia, Middle East and more than 50 countries.



Cooperation Partners

> 90

# NEON SILICONE TUBE SIZES

- Optimal Performance
- More convenient installation
- More extensive application

## Black Neon Strip Light

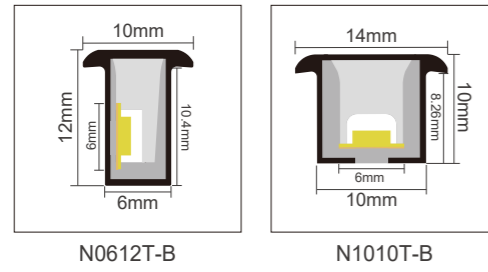

## Recessed Neon

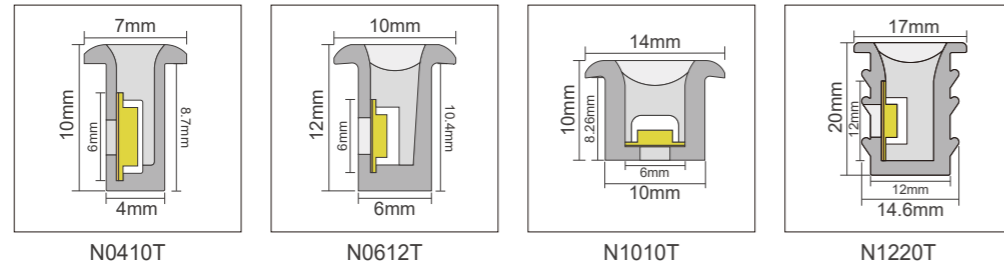

## 3D Bend

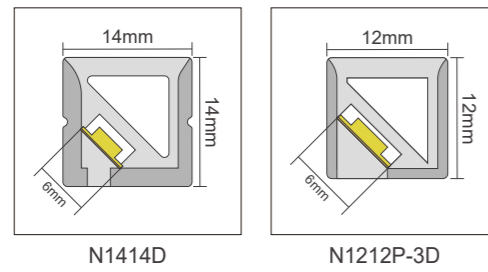

## Side Bend

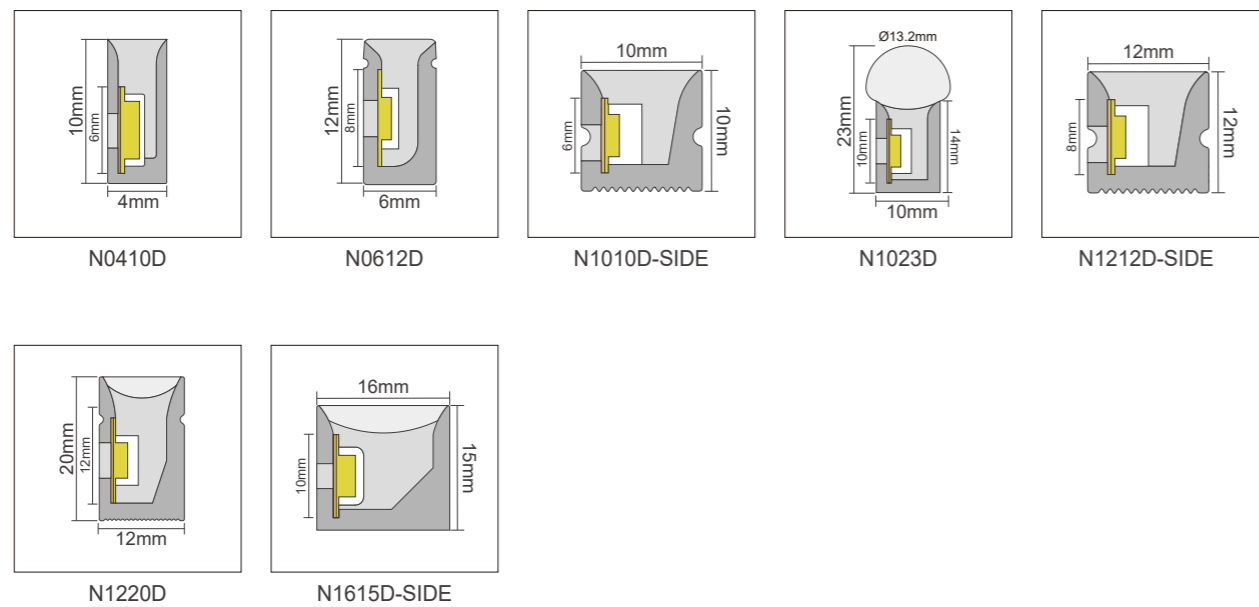

## Top Bend

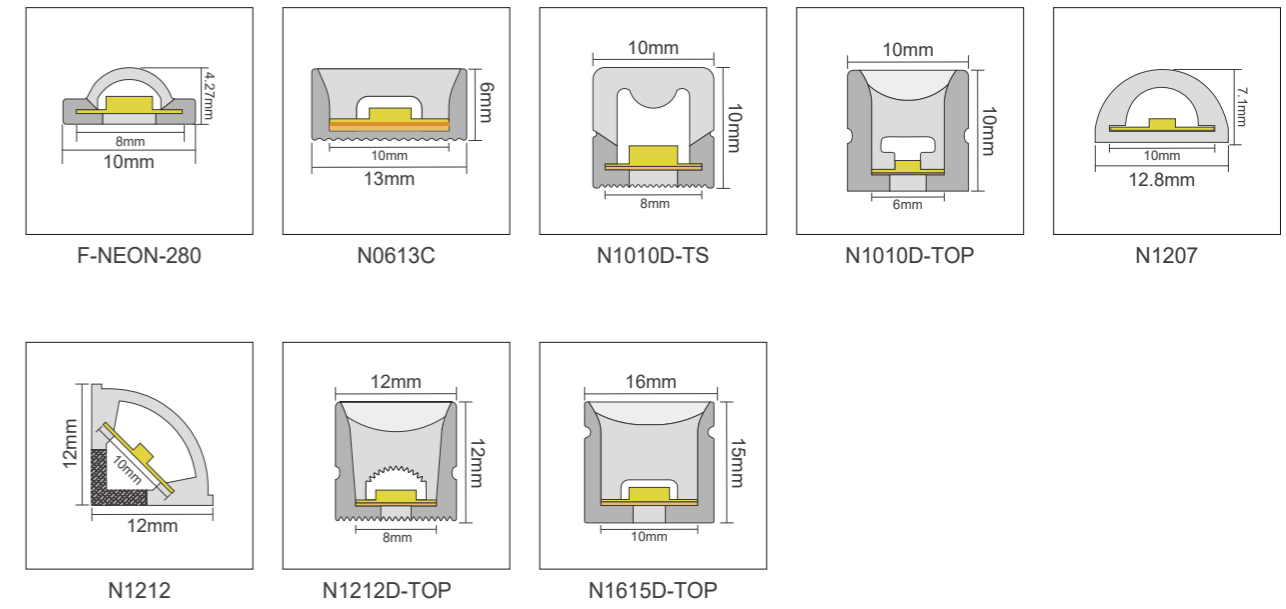

## 360° Neon

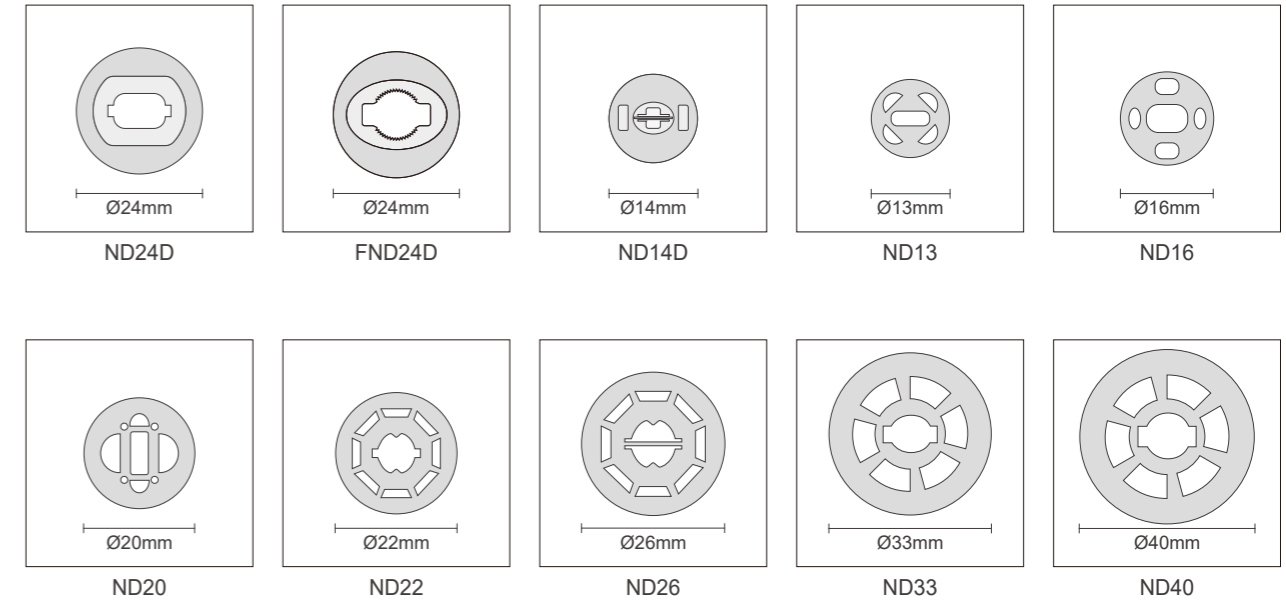

## Rectangle Neon Silicone Tube

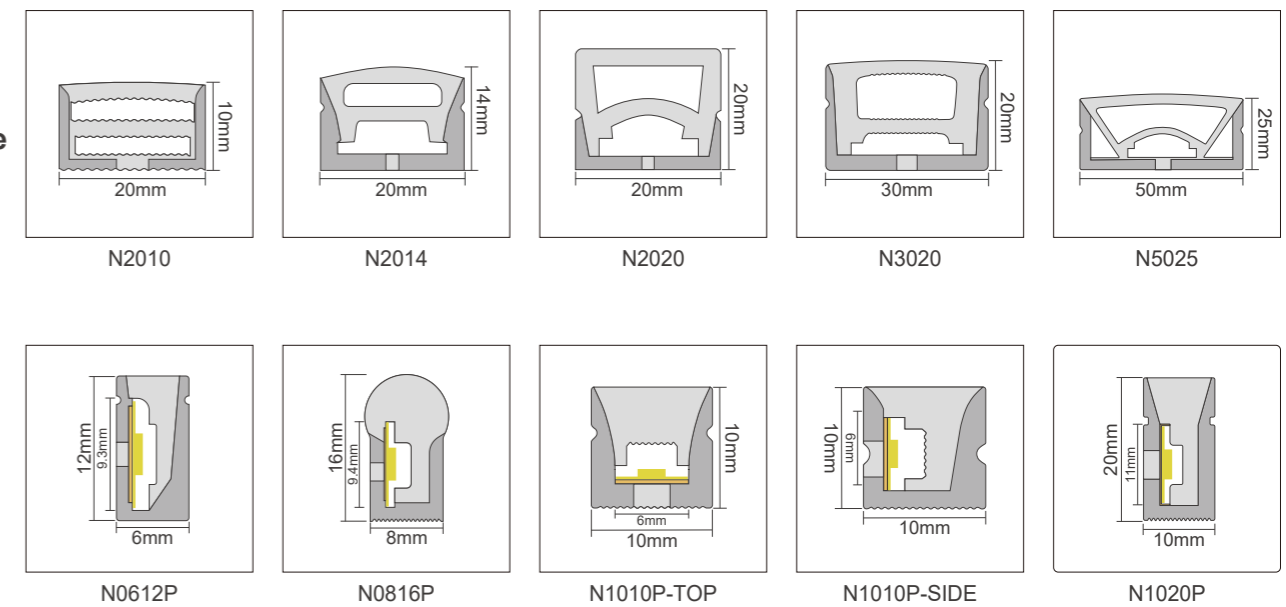

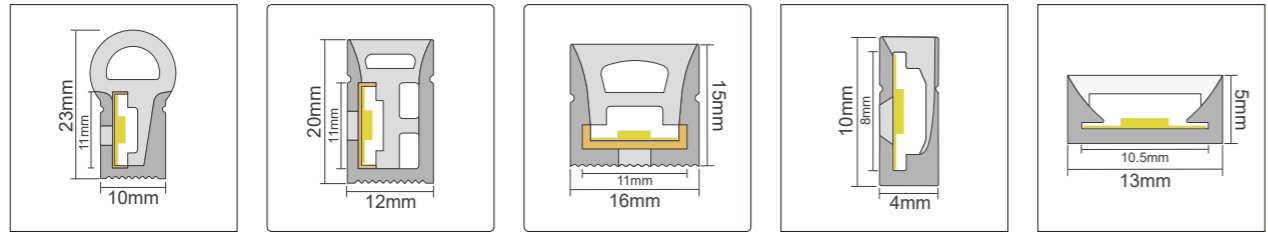

N1023P

N1220P

N1615P

N0410B

N0513

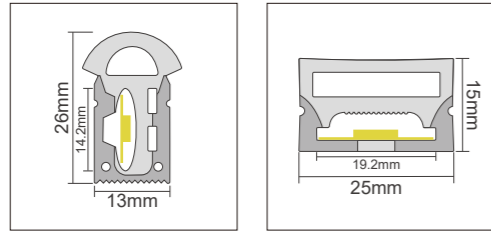

N1326

N2515

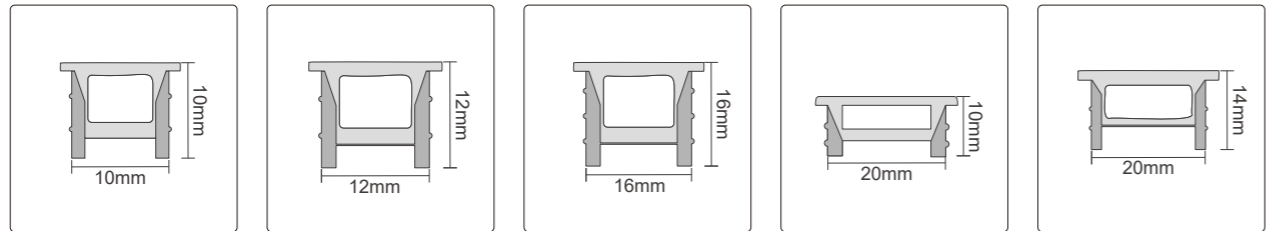

NC1010

NC1212

NC1616

NC2010

NC2014

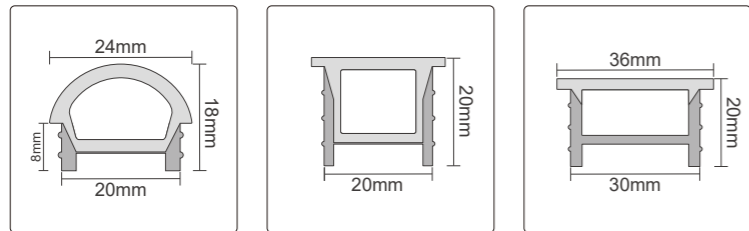

NC2018

NC2020

NC3020

**Rectangle  
Neon Silicone  
Cover**





## Black Neon Strip Light



# N0612T-B

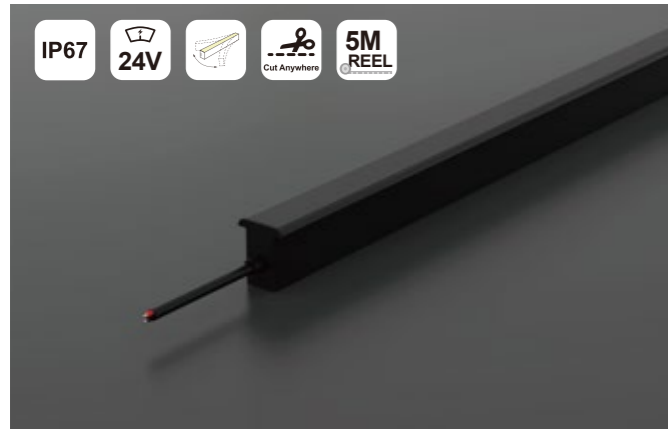

- Product size: 6\*12mm
- N.W.(G/M): 115g
- Material: Silicone
- Length: 5M/reel, Customized
- Cable output: 300mm cable output on both ends
- Dotless and beautiful lighting
- Suitable for diverse scenarios and creative designs.
- Resistant to weather, corrosion, and UV exposure.
- Meets international standards for safety and reliability.

WW NW CW

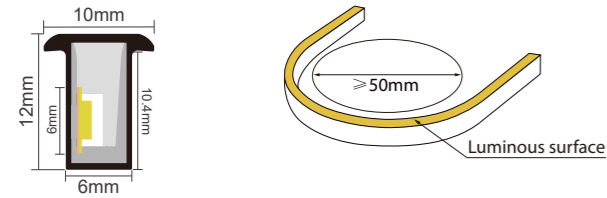

### Recommend LED strip parameters

Series	Unit cut	LED Qty/M	Voltage	Power/M
WHT	7LED/41.67mm	168	24V	9.6W
WHT	cut anywhere	180	24V	9.6W

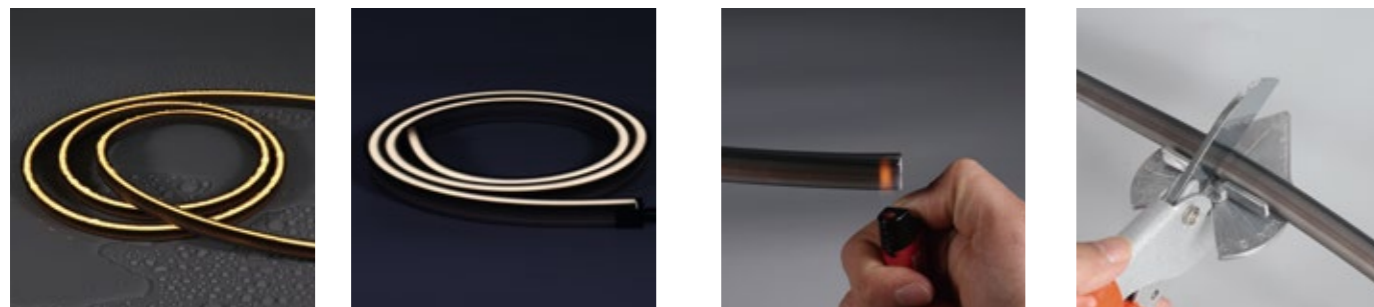

# N1010T-B

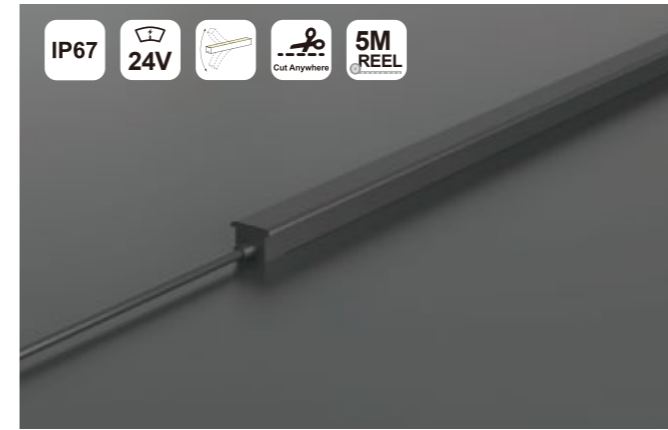

- Product size: 10\*10mm
- N.W.(G/M): 120g
- Material: Silicone
- Length: 5M/reel, Customized
- Cable output: 300mm cable output on both ends
- Dotless and beautiful lighting
- Suitable for diverse scenarios and creative designs.
- Resistant to weather, corrosion, and UV exposure.
- Meets international standards for safety and reliability.

WW NW CW

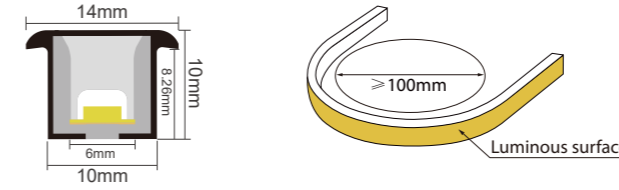

### Recommended Accessories

Silicone Endcap	One End Cap + One Plug Straight Outlet	
Glue	10g/pcs	

### Recommend LED strip parameters

Series	Unit cut	LED Qty/M	Voltage	Power/M
WHT	7LED/41.67mm	168	24V	9.6W
WHT	cut anywhere	180	24V	9.6W





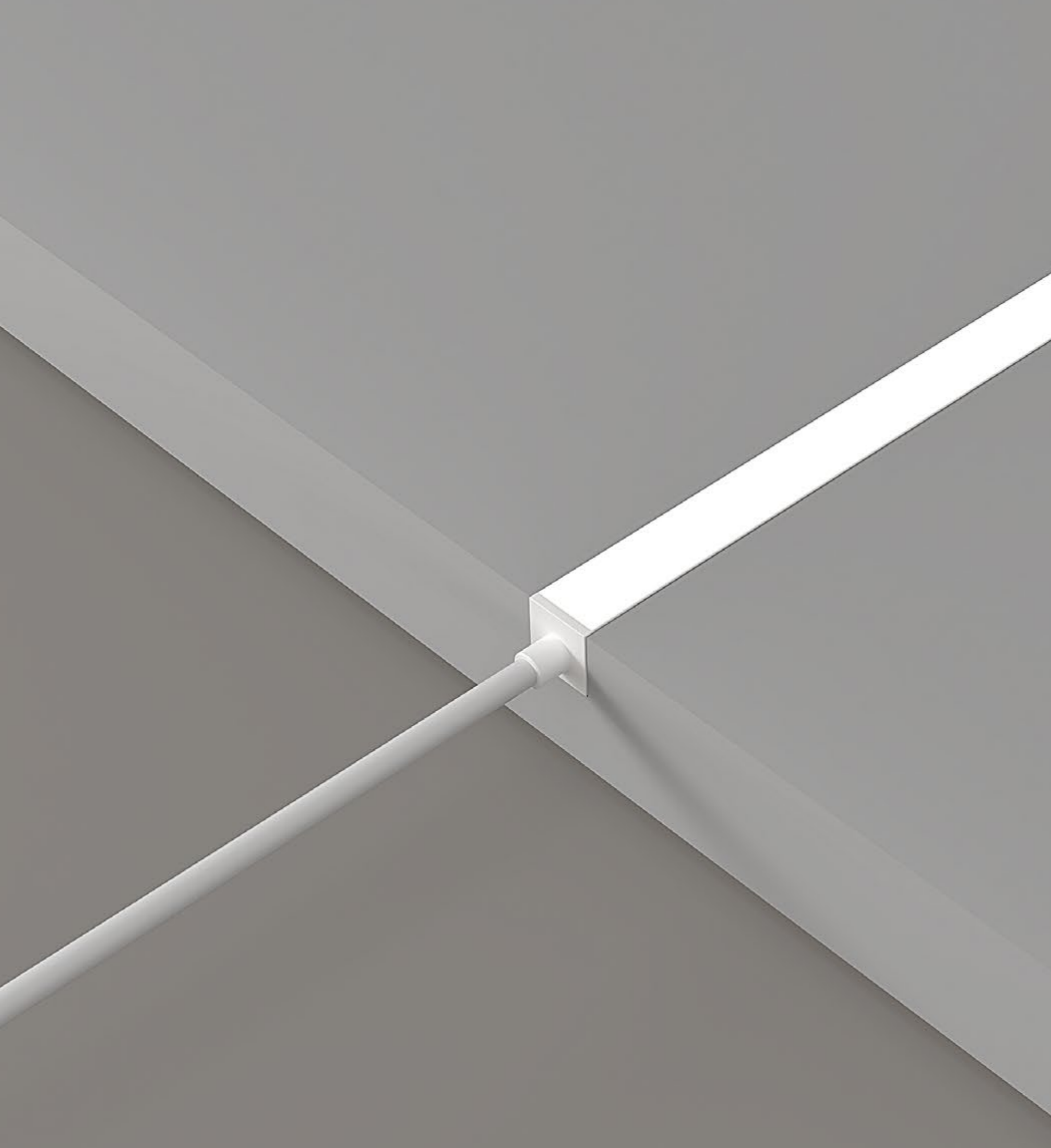

## Recessed Neon



# N0410T

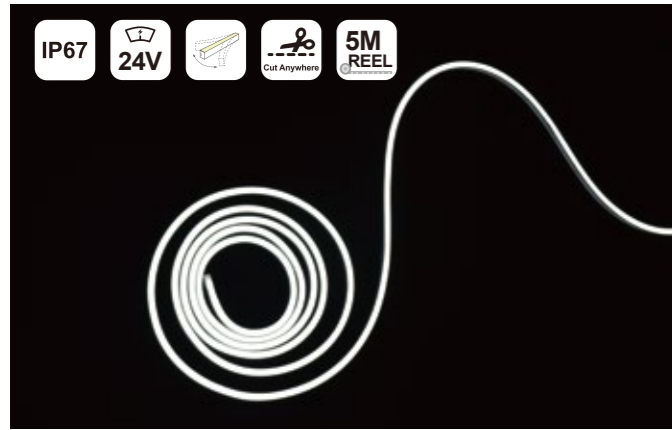

- Product size: 4\*10mm
- N.W.(G/M): 80g
- Material: Silicone
- Length: 5M/reel, Customized
- Cable output: 300mm cable output on both ends
- Dotless and beautiful lighting
- Suitable for diverse scenarios and creative designs.
- Resistant to weather, corrosion, and UV exposure.
- Meets international standards for safety and reliability.

WW NW CW

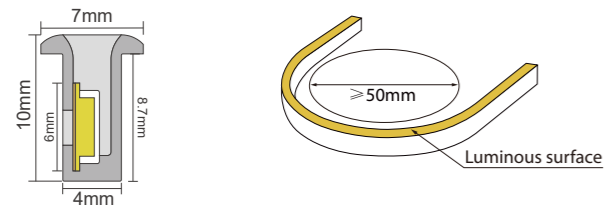

### Recommend LED strip parameters

Series	Unit cut	LED Qty/M	Voltage	Power/M
WHT	7LED/41.67mm	168	24V	9.6W
WHT	cut anywhere	180	24V	9.6W

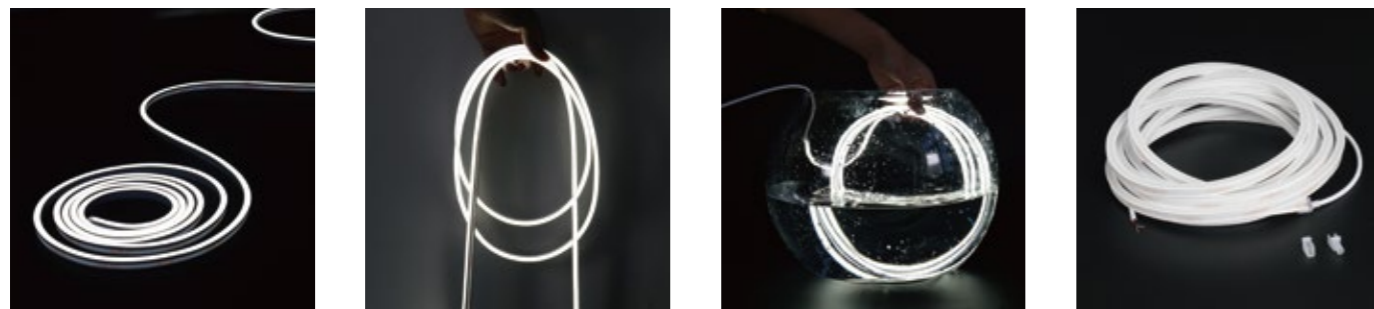

# N0612T



- Product size: 6\*12mm
- N.W.(G/M): 110g
- Material: Silicone
- Length: 5M/reel, Customized
- Cable output: 300mm cable output on both ends
- Dotless and beautiful lighting
- Suitable for diverse scenarios and creative designs.
- Resistant to weather, corrosion, and UV exposure.
- Meets international standards for safety and reliability.

WW NW CW

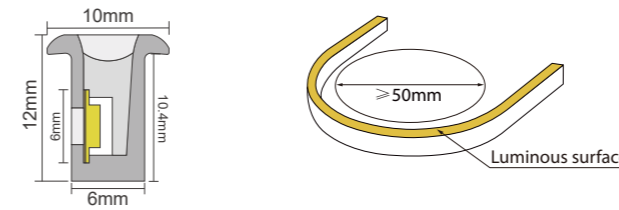

### Recommend LED strip parameters

Series	Unit cut	LED Qty/M	Voltage	Power/M
WHT	7LED/41.67mm	168	24V	9.6W
WHT	cut anywhere	180	24V	9.6W

### Recommended Accessories

Silicone Endcap	One End Cap + One Plug Straight Outlet	
Silicone Endcap	One End Cap + One Plug Bottom Outlet	
Glue	10g/pcs	

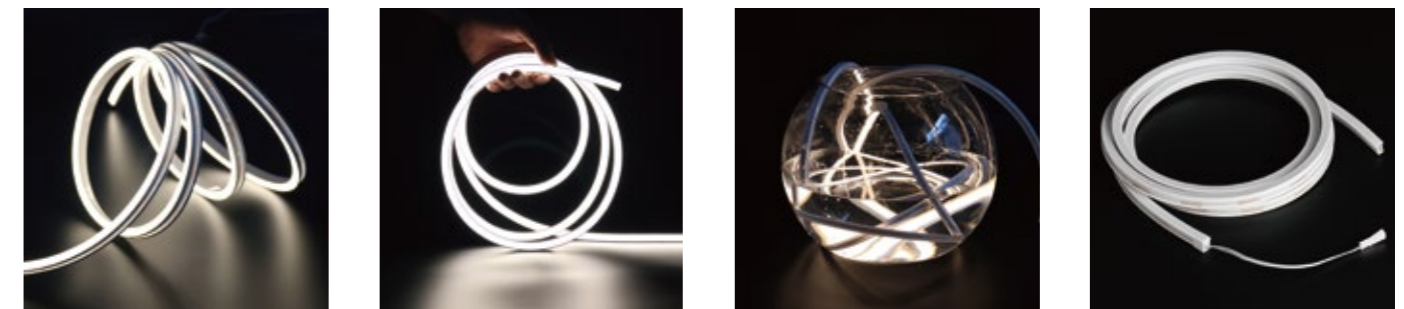

# N1010T



- Product size: 10\*10mm
- N.W.(G/M): 125g
- Material: Silicone
- Length: 5M/reel, Customized
- Cable output: 300mm cable output on both ends
- Dotless and beautiful lighting
- Suitable for diverse scenarios and creative designs.
- Resistant to weather, corrosion, and UV exposure.
- Meets international standards for safety and reliability.

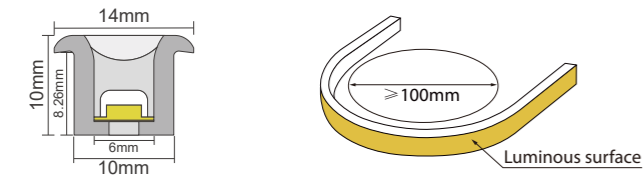

## Recommend LED strip parameters

Series	Unit cut	LED Qty/M	Voltage	Power/M
WHT	7LED/41.67mm	168	24V	9.6W
WHT	cut anywhere	180	24V	9.6W

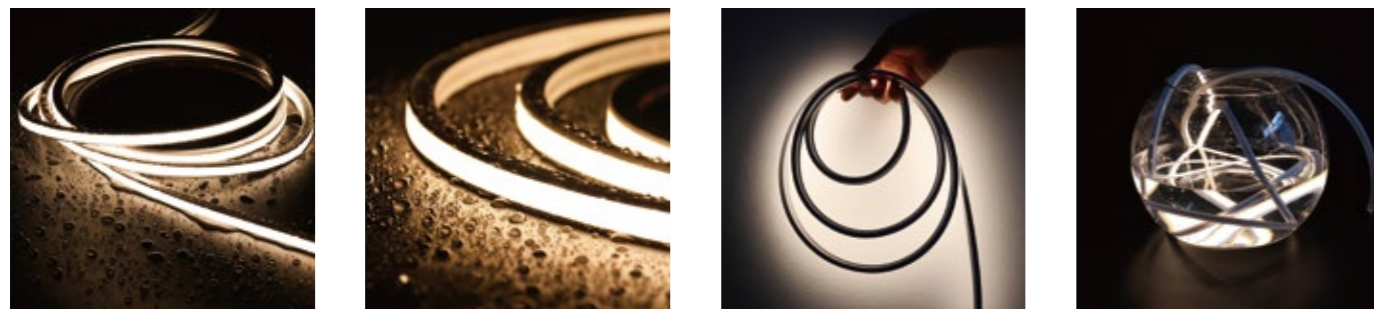

# N1220T

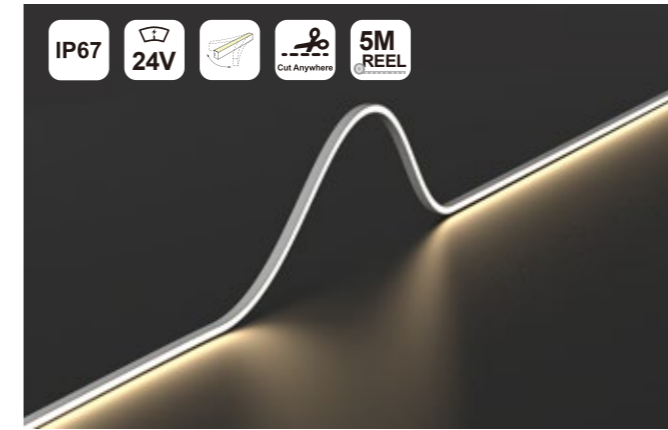

- Product size: 12\*20mm
- N.W.(G/M): 310g
- Material: Silicone
- Length: 5M/reel, Customized
- Cable output: 300mm cable output on both ends
- Dotless and beautiful lighting
- Suitable for diverse scenarios and creative designs.
- Resistant to weather, corrosion, and UV exposure.
- Meets international standards for safety and reliability.

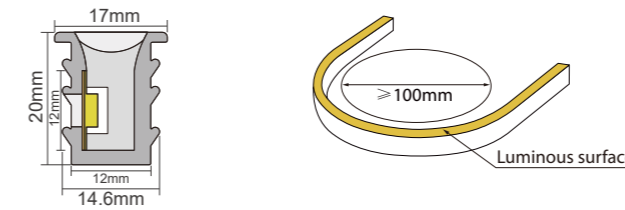

## Recommend LED strip parameters

Series	Unit cut	LED Qty/M	Voltage	Power/M
WHT	6LED/50mm	120	24V	14.4W
WHT	8LED/50mm	160	24V	14.4W
TW	6LED/50mm	120	24V	14.4W
RGB	6LED/50mm	120	24V	14.4W
RGBW	6LED/62.5mm	96	24V	15W
SPIRGB	6LED/71.4mm	84	24V	15W
DMX512 GRBW	12LED/125mm	96	24V	16.8W
WHT	cut anywhere	180	24V	14.4W

## Recommended Accessories

Injection Moulded Endcap	Top Wire Outlet	
Injection Moulded Endcap	No Wire Outlet	

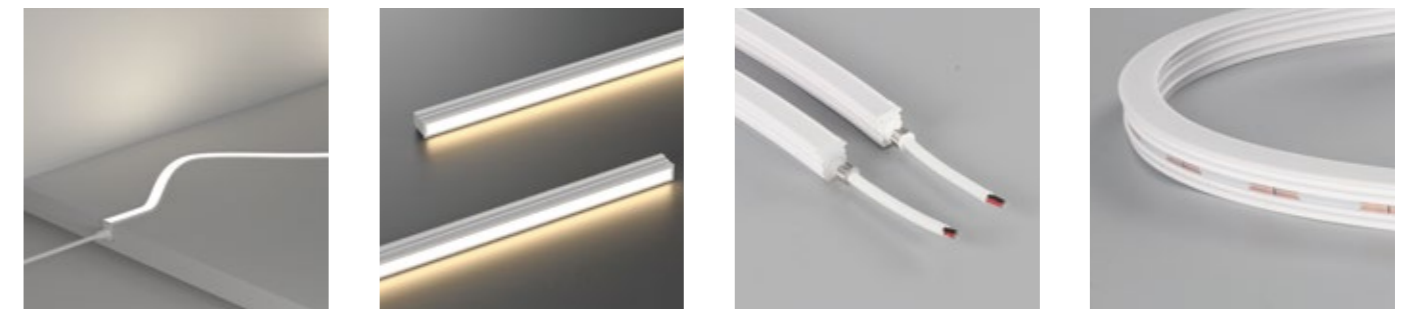



## 3D Bend



# N1414D

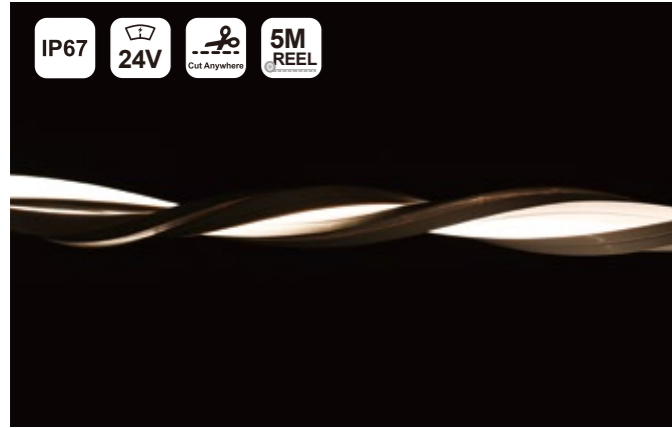

- Product size: 14\*14mm
- N.W.(G/M): 200g
- Material: Silicone
- Length: 5M/reel, Customized
- Cable output: 300mm cable output on both ends
- Dotless and beautiful lighting
- Suitable for diverse scenarios and creative designs.
- Resistant to weather, corrosion, and UV exposure.
- Meets international standards for safety and reliability.

WW NW CW

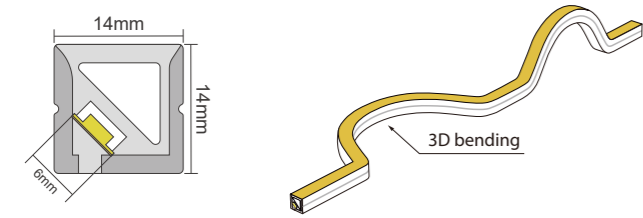

### Recommend LED strip parameters

Series	Unit cut	LED Qty/M	Voltage	Power/M
WHT	7LED/41.67mm	168	24V	9.6W
WHT	cut anywhere	180	24V	9.6W

### Recommended Accessories

Mounting Aluminium Profile	1 Meter With Screws	
Mounting Clip	30mm/pc With Screws	
Curved Profile	1 Meter With Screws	
Injection Moulded Endcap	Top Wire Outlet	
Injection Moulded Endcap	Bottom Wire Outlet	
Injection Moulded Endcap	Side Wire Outlet	
Injection Moulded Endcap	No Wire Outlet	
Silicone Endcap	One End Cap + One Plug Straight Outlet	
Silicone Endcap	One End Cap + One Plug Bottom Outlet	
Silicone Endcap	One End Cap + One Plug Side Outlet	
Glue	10g/pcs	



# N1212P-3D



- Product size: 12\*12mm
- N.W.(G/M): 195g
- Material: Silicone
- Length: 5M/reel, Customized
- Cable output: 300mm cable output on both ends
- Dotless and beautiful lighting
- Suitable for diverse scenarios and creative designs.
- Resistant to weather, corrosion, and UV exposure.
- Meets international standards for safety and reliability.

WW NW CW

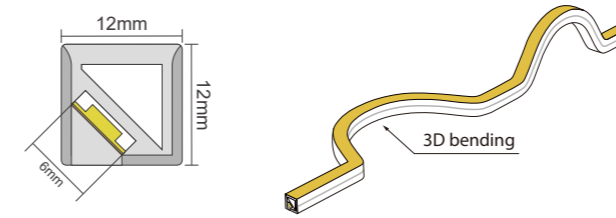

### Recommend LED strip parameters

Series	Unit cut	LED Qty/M	Voltage	Power/M
WHT	7LED/41.67mm	168	24V	9.6W

### Recommended Accessories

Mounting Aluminium Profile	1 Meter With Screws	
Mounting Clip	30mm/pc With Screws	
Curved Profile	1 Meter With Screws	
Silicone Endcap	One End Cap + One Plug Straight Outlet	
Silicone Endcap	One End Cap + One Plug Bottom Outlet	
Silicone Endcap	One End Cap + One Plug Side Outlet	
Glue	10g/pcs	

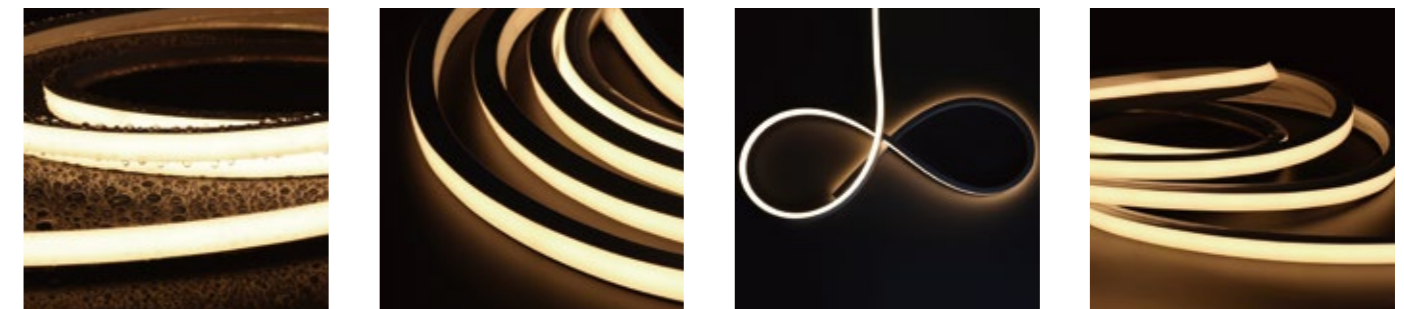

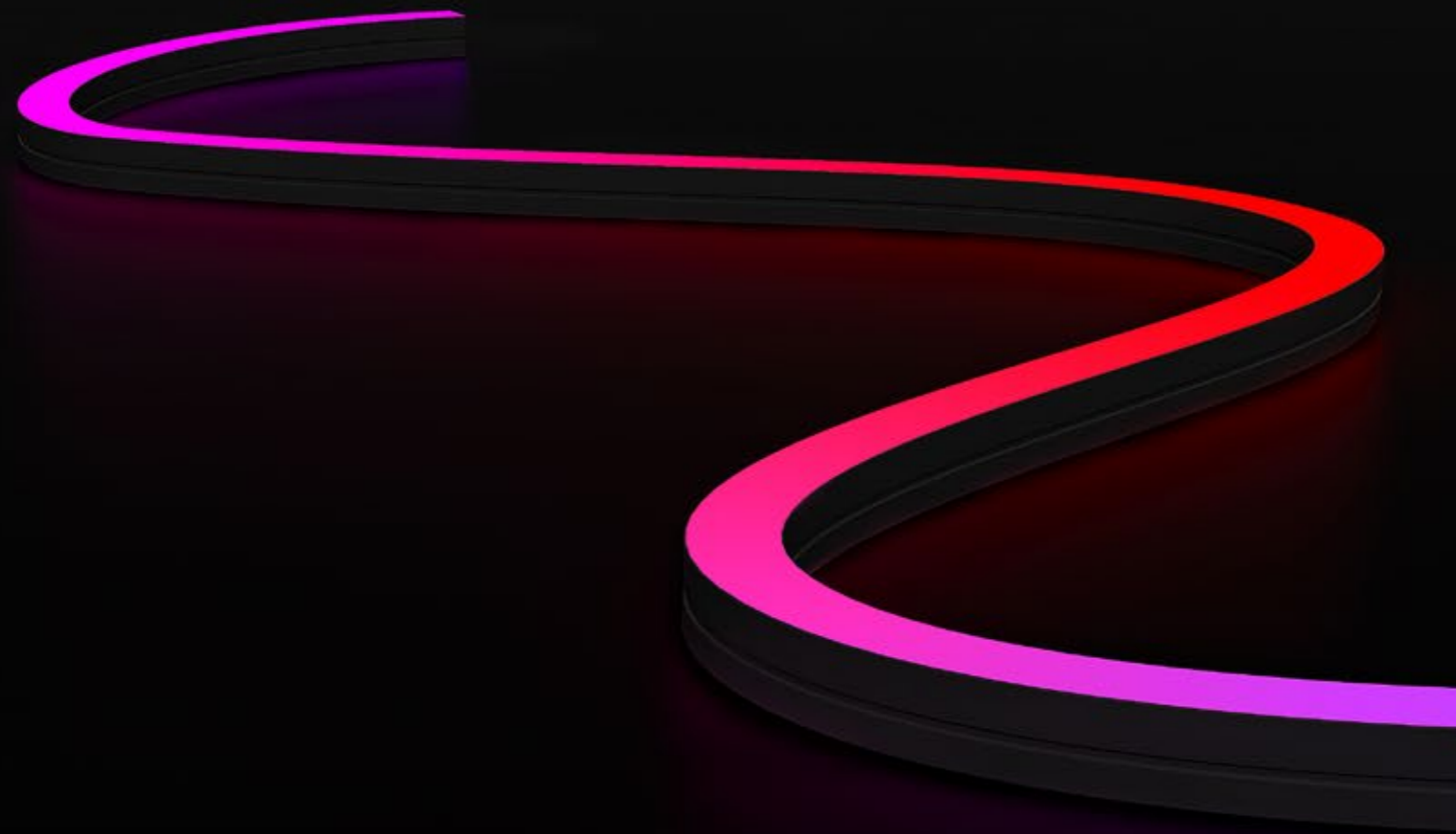

## Side Bend



# N0410D



- Product size: 4\*10mm
- N.W.(G/M): 80g
- Material: Silicone
- Length: 5M/reel, Customized
- Cable output: 300mm cable output on both ends
- Dotless and beautiful lighting
- Suitable for diverse scenarios and creative designs.
- Resistant to weather, corrosion, and UV exposure.
- Meets international standards for safety and reliability.

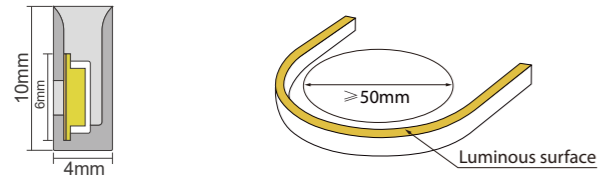

## Recommend LED strip parameters

Series	Unit cut	LED Qty/M	Voltage	Power/M
WHT	7LED/41.67mm	168	24V	9.6W
WHT	cut anywhere	180	24V	9.6W

## Recommended Accessories

Mounting Aluminium Profile	1 Meter With Screws	
Mounting Clip	30mm/pc With Screws	
Curved Profile	1 Meter With Screws	
Silicone Endcap	One End Cap + One Plug Straight Outlet	
Silicone Endcap	One End Cap + One Plug Side Outlet	
Glue	10g/pcs	

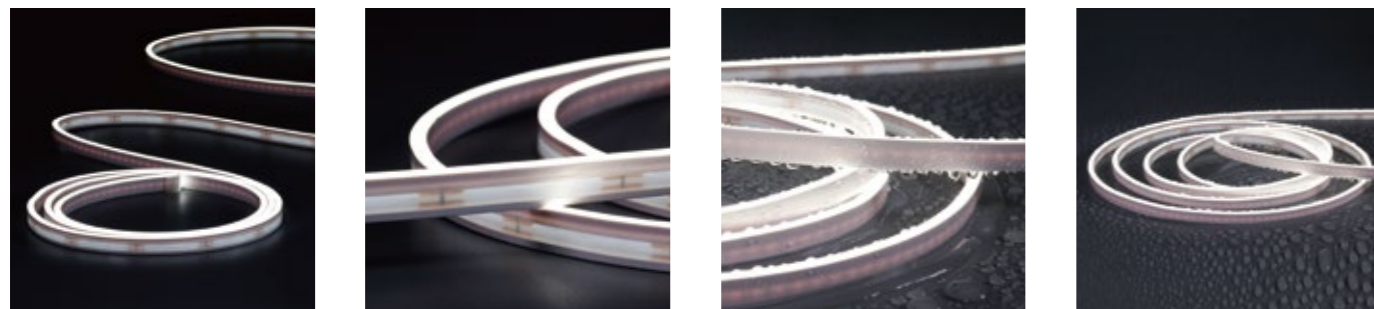

# N0612D



- Product size: 6\*12mm
- N.W.(G/M): 90g
- Material: Silicone
- Length: 5M/reel, Customized
- Cable output: 300mm cable output on both ends
- Dotless and beautiful lighting
- Suitable for diverse scenarios and creative designs.
- Resistant to weather, corrosion, and UV exposure.
- Meets international standards for safety and reliability.

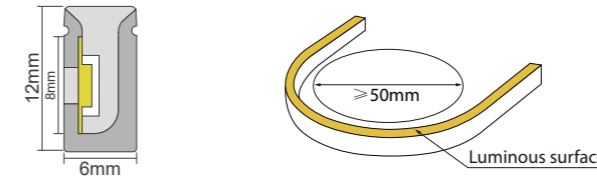
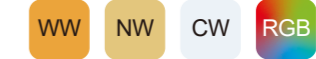

## Recommend LED strip parameters

Series	Unit cut	LED Qty/M	Voltage	Power/M
WHT	6LED/50mm	120	24V	9.6W
TW	6LED/50mm	120	24V	9.6W
RGB	6LED/50mm	120	24V	9.6W
WHT	cut anywhere	180	24V	9.6W

## Recommended Accessories

Mounting Aluminium Profile	1 Meter With Screws	
Mounting Clip	30mm/pc With Screws	
Curved Profile	1 Meter With Screws	
Injection Moulded Endcap	Top Wire Outlet	
Injection Moulded Endcap	Bottom Wire Outlet	
Injection Moulded Endcap	Side Wire Outlet	
Injection Moulded Endcap	No Wire Outlet	
Silicone Endcap	One End Cap + One Plug Straight Outlet	
Silicone Endcap	One End Cap + One Plug Bottom Outlet	
Silicone Endcap	One End Cap + One Plug Side Outlet	
Glue	10g/pcs	



# N1010D-SIDE



- Product size: 10\*10mm
- N.W.(G/M): 120g
- Material: Silicone
- Length: 5M/reel, Customized
- Cable output: 300mm cable output on both ends
- Dotless and beautiful lighting
- Suitable for diverse scenarios and creative designs.
- Resistant to weather, corrosion, and UV exposure.
- Meets international standards for safety and reliability.

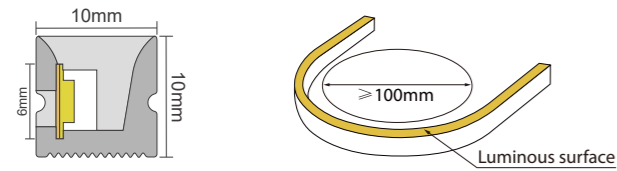

## Recommend LED strip parameters

Series	Unit cut	LED Qty/M	Voltage	Power/M
WHT	7LED/41.67mm	168	24V	9.6W
WHT	cut anywhere	180	24V	9.6W

## Recommended Accessories

Mounting Aluminium Profile	1 Meter With Screws	
Mounting Clip	30mm/pc With Screws	
Curved Profile	1 Meter With Screws	
Injection Moulded Endcap	Top Wire Outlet	
Injection Moulded Endcap	Bottom Wire Outlet	
Injection Moulded Endcap	Side Wire Outlet	
Injection Moulded Endcap	No Wire Outlet	
Silicone Endcap	One End Cap + One Plug Straight Outlet	
Silicone Endcap	One End Cap + One Plug Bottom Outlet	
Silicone Endcap	One End Cap + One Plug Side Outlet	
Glue	10g/pcs	

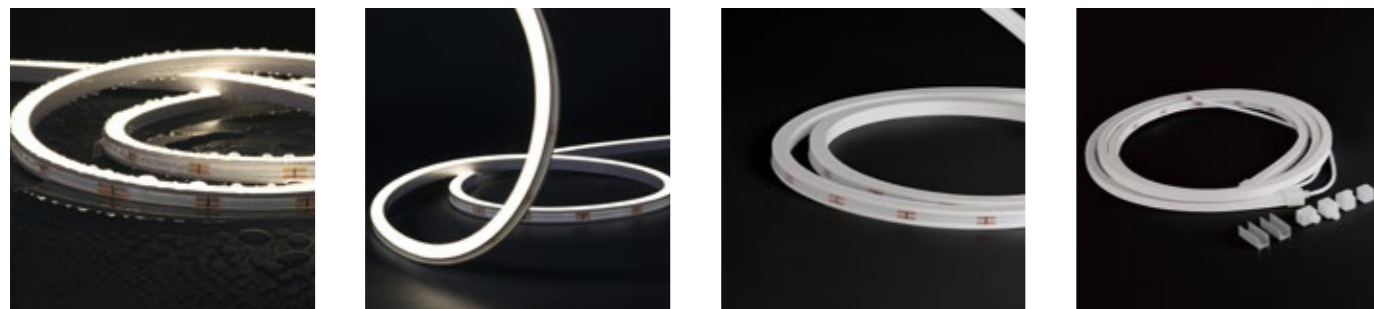

# N1023D



- Product size: 10\*23mm
- N.W.(G/M): 295g
- Material: Silicone
- Length: 5M/reel, Customized
- Cable output: 300mm cable output on both ends
- Dotless and beautiful lighting
- Suitable for diverse scenarios and creative designs.
- Resistant to weather, corrosion, and UV exposure.
- Meets international standards for safety and reliability.

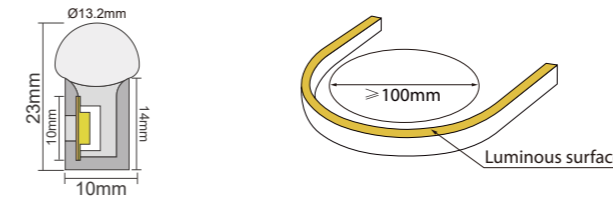

## Recommend LED strip parameters

Series	Unit cut	LED Qty/M	Voltage	Power/M
WHT	6LED/50mm	120	24V	14.4W
WHT	8LED/50mm	160	24V	14.4W
TW	6LED/50mm	120	24V	14.4W
RGB	6LED/50mm	120	24V	14.4W
RGBW	6LED/62.5mm	96	24V	15W
SPIRGB	6LED/71.4mm	84	24V	15W
WHT	cut anywhere	180	24V	14.4W

## Recommended Accessories

Mounting Aluminium Profile	1 Meter With Screws	
Mounting Clip	30mm/pc With Screws	
Curved Profile	1 Meter With Screws	
Injection Moulded Endcap	Top Wire Outlet	
Injection Moulded Endcap	No Wire Outlet	
Silicone Endcap	One End Cap + One Plug Straight Outlet	
Silicone Endcap	One End Cap + One Plug Bottom Outlet	
Silicone Endcap	One End Cap + One Plug Side Outlet	
Glue	10g/pcs	





# N1212D-SIDE



- Product size: 12\*12mm
- N.W.(G/M): 200g
- Material: Silicone
- Length: 5M/reel, Customized
- Cable output: 300mm cable output on both ends
- Dotless and beautiful lighting
- Suitable for diverse scenarios and creative designs.
- Resistant to weather, corrosion, and UV exposure.
- Meets international standards for safety and reliability.

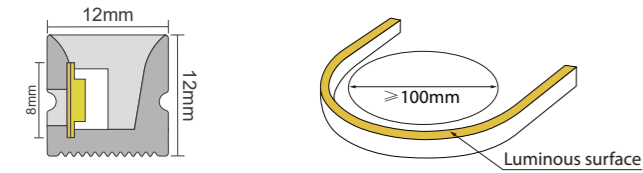
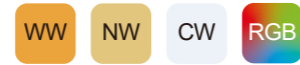

## Recommend LED strip parameters

Series	Unit cut	LED Qty/M	Voltage	Power/M
WHT	6LED/50mm	120	24V	9.6W
TW	6LED/50mm	120	24V	9.6W
RGB	6LED/50mm	120	24V	9.6W
WHT	cut anywhere	180	24V	9.6W

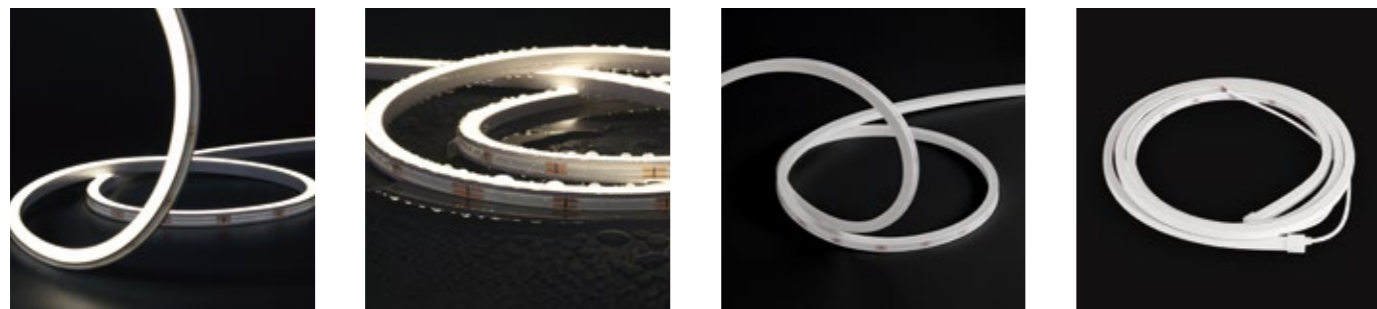

# N1220D



- Product size: 12\*20mm
- N.W.(G/M): 300g
- Material: Silicone
- Length: 5M/reel, Customized
- Cable output: 300mm cable output on both ends
- Dotless and beautiful lighting
- Suitable for diverse scenarios and creative designs.
- Resistant to weather, corrosion, and UV exposure.
- Meets international standards for safety and reliability.



## Recommend LED strip parameters

Series	Unit cut	LED Qty/M	Voltage	Power/M
WHT	6LED/50mm	120	24V	14.4W
WHT	8LED/50mm	160	24V	14.4W
TW	6LED/50mm	120	24V	14.4W
RGB	6LED/50mm	120	24V	14.4W
RGBW	6LED/62.5mm	96	24V	15W
SPIRGB	6LED/71.4mm	84	24V	15W
DMX512 GRBW	12LED/125mm	96	24V	16.8W
WHT	cut anywhere	180	24V	14.4W

## Recommended Accessories

Mounting Aluminium Profile	1 Meter With Screws	
Mounting Clip	30mm/pc With Screws	
Curved Profile	1 Meter With Screws	
Injection Moulded Endcap	Top Wire Outlet	
Injection Moulded Endcap	Bottom Wire Outlet	
Injection Moulded Endcap	Side Wire Outlet	
Injection Moulded Endcap	No Wire Outlet	
Silicone Endcap	One End Cap + One Plug Straight Outlet	
Silicone Endcap	One End Cap + One Plug Bottom Outlet	
Silicone Endcap	One End Cap + One Plug Side Outlet	
Glue	10g/pcs	



# N1615D-SIDE



- Product size: 16\*15mm
- N.W.(G/M): 210g
- Material: Silicone
- Length: 5M/reel, Customized
- Cable output: 300mm cable output on both ends
- Dotless and beautiful lighting
- Suitable for diverse scenarios and creative designs.
- Resistant to weather, corrosion, and UV exposure.
- Meets international standards for safety and reliability.

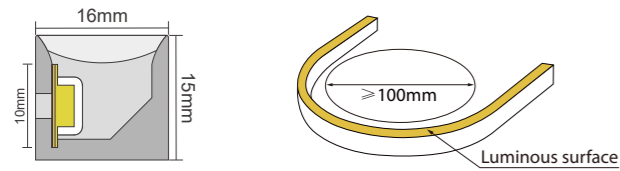

## Recommend LED strip parameters

Series	Unit cut	LED Qty/M	Voltage	Power/M
WHT	6LED/50mm	120	24V	14.4W
WHT	8LED/50mm	160	24V	14.4W
TW	6LED/50mm	120	24V	14.4W
RGB	6LED/50mm	120	24V	14.4W
RGBW	6LED/62.5mm	96	24V	15W
SPIRGB	6LED/71.4mm	84	24V	15W
WHT	cut anywhere	180	24V	14.4W

## Recommended Accessories

Mounting Aluminium Profile	1 Meter With Screws	
Mounting Clip	30mm/pc With Screws	
Curved Profile	1 Meter With Screws	
Injection Moulded Endcap	Top Wire Outlet	
Injection Moulded Endcap	Bottom Wire Outlet	
Injection Moulded Endcap	Side Wire Outlet	
Injection Moulded Endcap	No Wire Outlet	
Silicone Endcap	One End Cap + One Plug Straight Outlet	
Silicone Endcap	One End Cap + One Plug Bottom Outlet	
Silicone Endcap	One End Cap + One Plug Side Outlet	
Glue	10g/pcs	

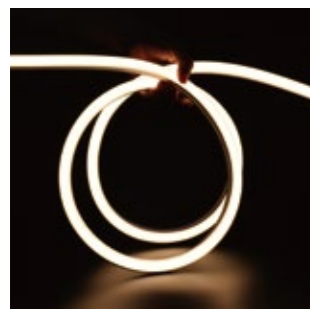

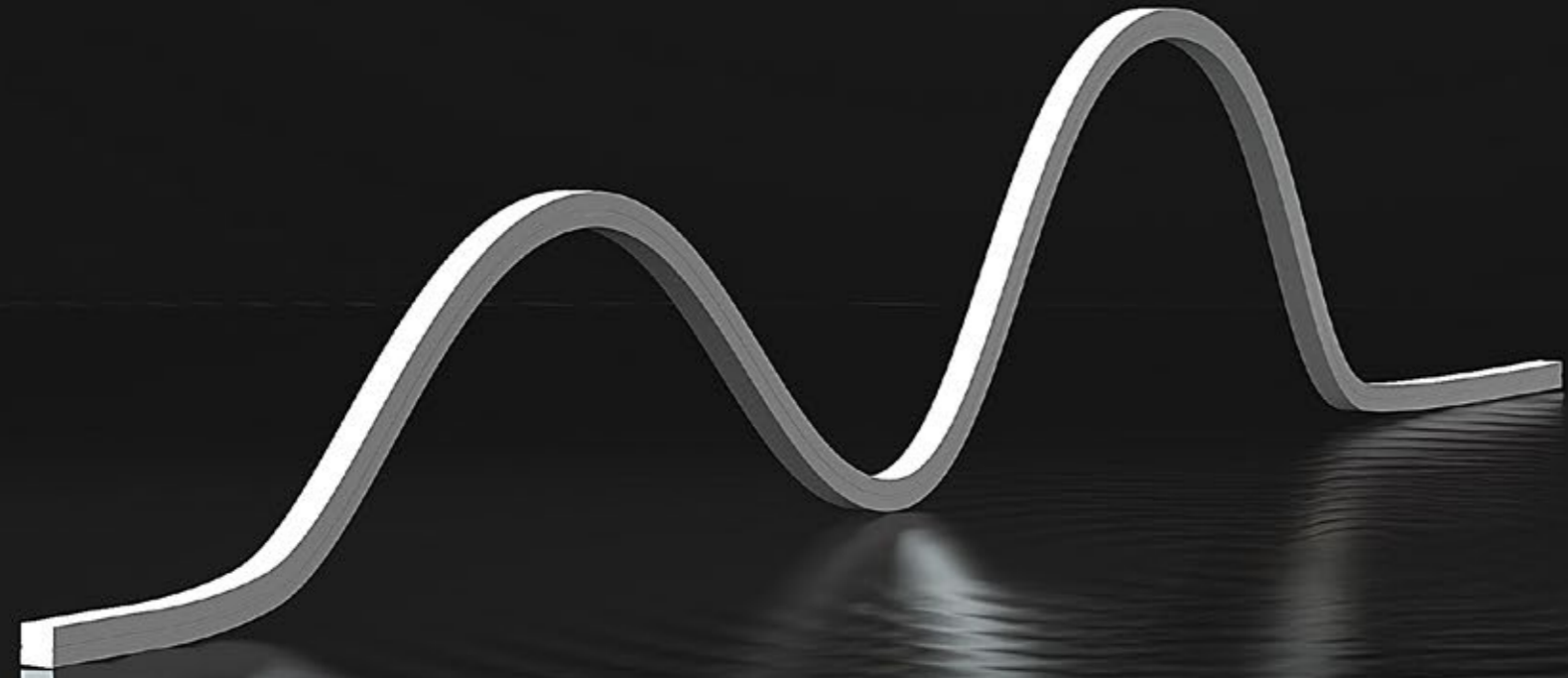

## Top Bend



# F-NEON-280

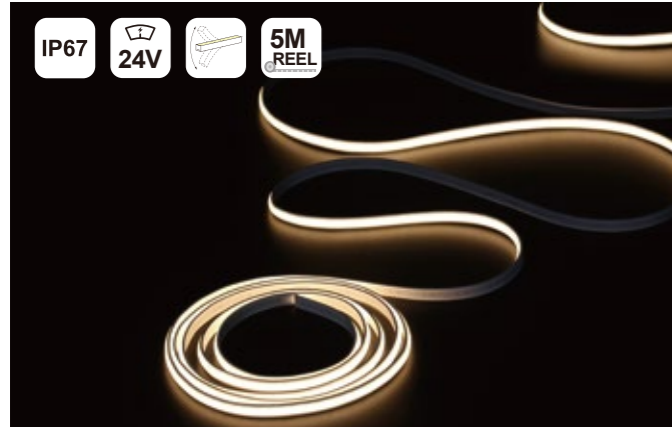

- Product size: 10\*4mm
- N.W.(G/M): 35g
- Material: Silicone
- Length: 5M/reel, Customized
- Cable output: 300mm cable output on both ends
- Dotless and beautiful lighting
- Suitable for diverse scenarios and creative designs.
- Resistant to weather, corrosion, and UV exposure.
- Meets international standards for safety and reliability.

WW NW CW

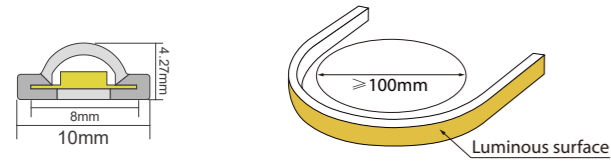

## Recommend LED strip parameters

Series	Unit cut	LED Qty/M	Voltage	Power/M
WHT	7LED/25mm	280	24V	9.6W

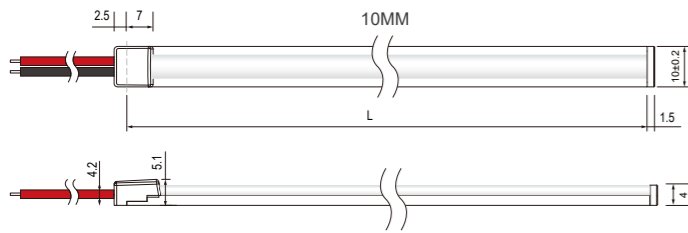

# N0613C



- Product size: 13\*6mm
- N.W.(G/M): 140g
- Material: Silicone
- Length: 5M/reel, Customized
- Cable output: 300mm cable output on both ends
- Dotless and beautiful lighting
- Suitable for diverse scenarios and creative designs.
- Resistant to weather, corrosion, and UV exposure.
- Meets international standards for safety and reliability.
- 25m without voltage drop, get the power from one end

WW NW CW

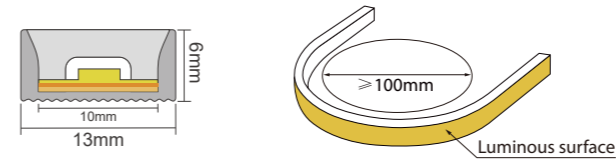

## Recommend LED strip parameters

Series	Unit cut	LED Qty/M	Voltage	Power/M
WHT	6LED/50mm	120	24V	9.6W

## Recommended Accessories

Fixed clips	30mm/pc With Screws	
Silicone Endcap	One End Cap + One Plug Straight Outlet	
End cap with power input connector		
Glue	10g/pcs	



# N1010D-TS

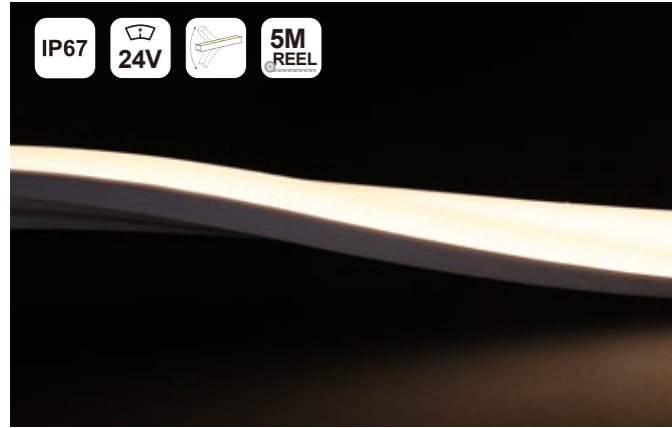

- Product size: 10\*10mm
- N.W.(G/M): 90g
- Material: Silicone
- Length: 5M/reel, Customized
- Cable output: 300mm cable output on both ends
- Dotless and beautiful lighting
- Suitable for diverse scenarios and creative designs.
- Resistant to weather, corrosion, and UV exposure.
- Meets international standards for safety and reliability.

WW NW CW

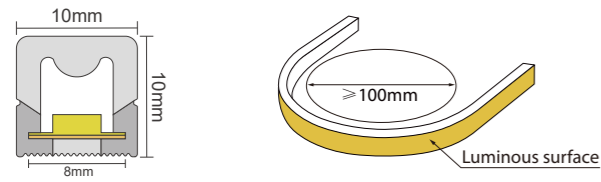

## Recommend LED strip parameters

Series	Unit cut	LED Qty/M	Voltage	Power/M
WHT	7LED/33.33mm	210	24V	9.6W



# N1010D-TOP



- Product size: 10\*10mm
- N.W.(G/M): 135g
- Material: Silicone
- Length: 5M/reel, Customized
- Cable output: 300mm cable output on both ends
- Dotless and beautiful lighting
- Suitable for diverse scenarios and creative designs.
- Resistant to weather, corrosion, and UV exposure.
- Meets international standards for safety and reliability.

WW NW CW

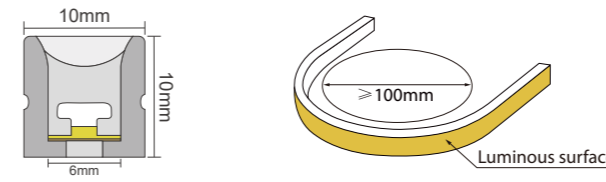

## Recommend LED strip parameters

Series	Unit cut	LED Qty/M	Voltage	Power/M
WHT	7LED/41.67mm	168	24V	9.6W
WHT	cut anywhere	180	24V	9.6W

## Recommended Accessories

Mounting Aluminium Profile	1 Meter With Screws	
Mounting Clip	Metal With Screws	
Curved Profile	1 Meter With Screws	
Injection Moulded Endcap	Top Wire Outlet	
Injection Moulded Endcap	Bottom Wire Outlet	
Injection Moulded Endcap	Side Wire Outlet	
Injection Moulded Endcap	No Wire Outlet	
Silicone Endcap	One End Cap + One Plug Straight Outlet	
Silicone Endcap	One End Cap + One Plug Bottom Outlet	
Silicone Endcap	One End Cap + One Plug Side Outlet	
Glue	10g/pcs	



# N1207

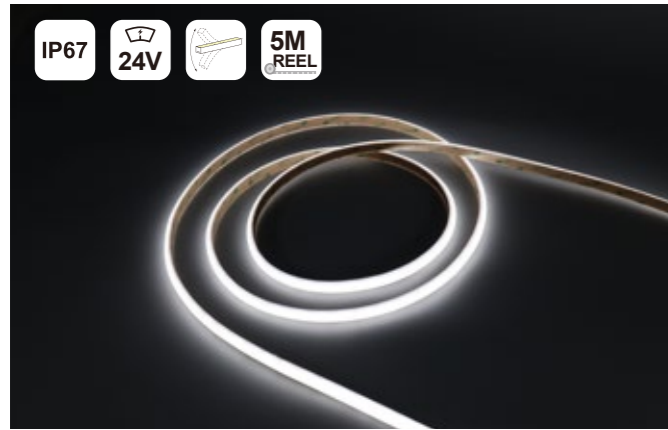

- Product size: 12.8\*7mm
- N.W.(G/M): 70g
- Material: Silicone
- Length: 5M/reel, Customized
- Cable output: 300mm cable output on both ends
- Dotless and beautiful lighting
- Suitable for diverse scenarios and creative designs.
- Resistant to weather, corrosion, and UV exposure.
- Meets international standards for safety and reliability.

WW NW CW

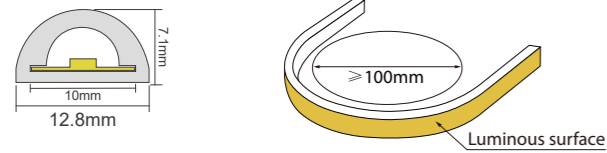

## Recommend LED strip parameters

Series	Unit cut	LED Qty/M	Voltage	Power/M
WHT	6LED/20mm	300	24V	14.4W
WHT	6LED	300	24V	19.2W



# N1212



- Product size: 12\*12mm
- N.W.(G/M): 110g
- Material: Silicone
- Length: 5M/reel, Customized
- Cable output: 300mm cable output on both ends
- Dotless and beautiful lighting
- Suitable for diverse scenarios and creative designs.
- Resistant to weather, corrosion, and UV exposure.
- Meets international standards for safety and reliability.

WW NW CW

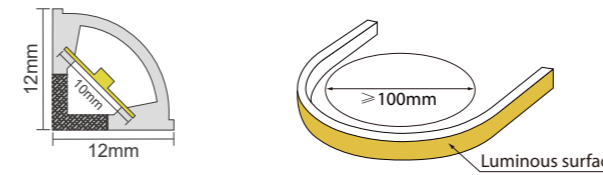

## Recommend LED strip parameters

Series	Unit cut	LED Qty/M	Voltage	Power/M
WHT	6LED/20mm	300	24V	19.2W



# N1212D-TOP



- Product size: 12\*12mm
- N.W.(G/M): 190g
- Material: Silicone
- Length: 5M/reel, Customized
- Cable output: 300mm cable output on both ends
- Dotless and beautiful lighting
- Suitable for diverse scenarios and creative designs.
- Resistant to weather, corrosion, and UV exposure.
- Meets international standards for safety and reliability.

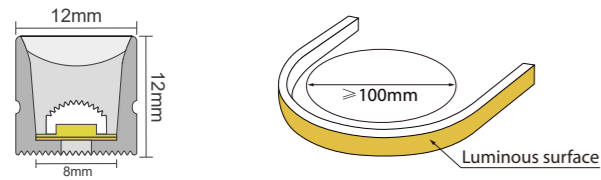
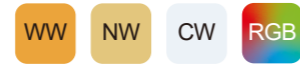

## Recommend LED strip parameters

Series	Unit cut	LED Qty/M	Voltage	Power/M
WHT	6LED/50mm	120	24V	9.6W
TW	6LED/50mm	120	24V	9.6W
RGB	6LED/50mm	120	24V	9.6W
WHT	cut anywhere	180	24V	9.6W

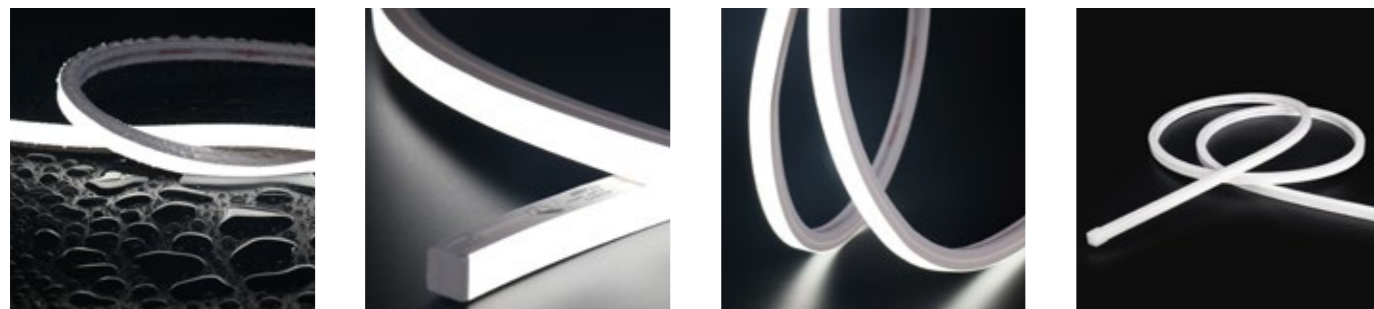

# N1615D-TOP



- Product size: 16\*15mm
- N.W.(G/M): 320g
- Material: Silicone
- Length: 5M/reel, Customized
- Cable output: 300mm cable output on both ends
- Dotless and beautiful lighting
- Suitable for diverse scenarios and creative designs.
- Resistant to weather, corrosion, and UV exposure.
- Meets international standards for safety and reliability.

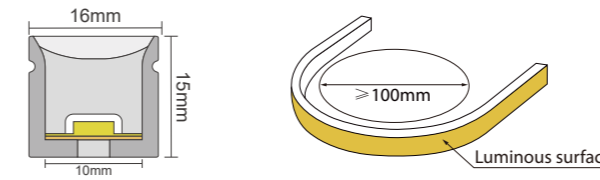

## Recommend LED strip parameters

Series	Unit cut	LED Qty/M	Voltage	Power/M
WHT	6LED/50mm	120	24V	14.4W
WHT	8LED/50mm	160	24V	14.4W
TW	6LED/50mm	120	24V	14.4W
RGB	6LED/50mm	120	24V	14.4W
RGBW	6LED/62.5mm	96	24V	15W
SPIRGB	6LED/71.4mm	84	24V	15W
DMX512	12LED/125mm	96	24V	16.8W
WHT	cut anywhere	180	24V	14.4W

## Recommended Accessories

Mounting Aluminium Profile	1 Meter With Screws	
Mounting Clip	30mm/pc With Screws	
Curved Profile	1 Meter With Screws	
Injection Moulded Endcap	Top Wire Outlet	
Injection Moulded Endcap	Bottom Wire Outlet	
Injection Moulded Endcap	Side Wire Outlet	
Injection Moulded Endcap	No Wire Outlet	
Silicone Endcap	One End Cap + One Plug Straight Outlet	
Silicone Endcap	One End Cap + One Plug Bottom Outlet	
Silicone Endcap	One End Cap + One Plug Side Outlet	
Glue	10g/pcs	

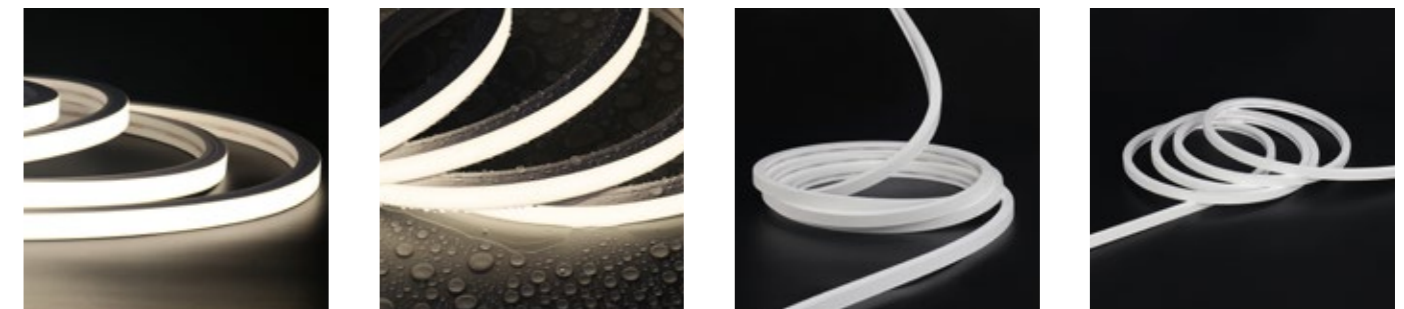



## 360° Neon





# ND24D

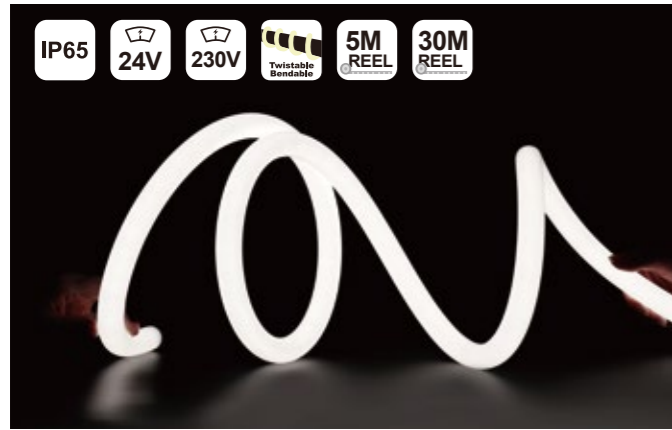

IP65 24V 230V Twistable Bendable 5M REEL 30M REEL

- Product size:  $\Phi 24\text{mm}$
- N.W.(G/M): 580g
- Material: Silicone
- Light transmittance: 75%
- Bending diameter:  $\Phi 100\text{mm}$
- Extrusion process: Dual color extrusion.
- 360° uniform light emission, without shadows.
- Application: Office/Home/Hotel/Exhibition/Hall.
- Suitable for diverse scenarios and creative designs.

WW NW CW

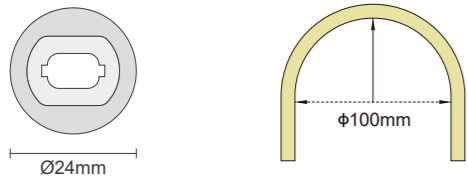

## Recommend LED strip parameters

Series	Unit cut	LED Qty/M	Voltage	Power/M
WHT	6LED	120	24V	9.6W
WHT	12LED	120	230V	10W

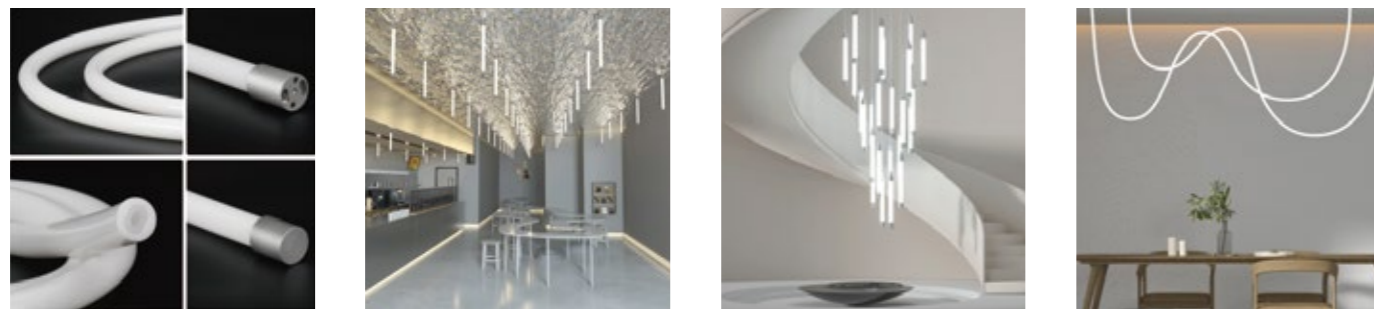
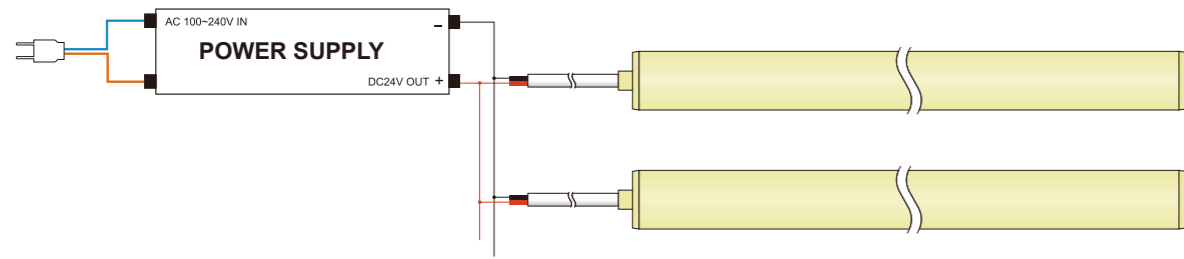

# Accessories

Model No.	Application	Accessories picture	Packing List	Accessories list
AS-ND24D-A Vertical ceiling			Quantities 20set N.W 0.35KG Total weight 8.2KG Package size L1070*W180*H145	1 meter round PC tube 1 pc Vertical Ceiling installation aluminum end cap 2 pcs fixed aluminum end caps 1 pc aluminum end cap without hole 2 pcs silicone end caps (1pc with hole, 1pc without hole) 8 pcs screws 2 pcs white plastic anchors 1 pc Phillips screwdriver 1 pc M4 hexagonal wrench
AS-ND24D-B Vertical hoisting			Quantities 20set N.W 0.45KG Total weight 10.2KG Package size L1070*W180*H145	1 meter round Plastic tube 1 pc Vertical Hoisting installation aluminum end cap 1 pc 1 meter Conductive Steel Rope with cable inside 1 pc aluminum end cap without hole 2 pcs silicone end caps (1pc with hole, 1pc without hole) 7 pcs screws 1 pc white plastic anchors 1 pc Phillips screwdriver
AS-ND24D-C Double-head ceiling			Quantities 73set N.W 0.11KG Total weight 9.2KG Package size L468*W375*237	2 pcs Vertical Ceiling installation aluminum end caps 2 pcs fixed aluminum end caps 2 pcs silicone end caps (1pc with hole, 1pc without hole) 10 pcs screws 4 pcs white plastic anchors 1 pc Phillips screwdriver 1 pc M4 hexagonal wrench
AS-ND24D-D Horizontal hoisting			Quantities 20set N.W 0.34KG Total weight 8KG Package size L1070*W180*145	1 meter round Plastic tube assembled with hanging clips 2 pcs steel rope with copper bolts 2 pcs screws for steel rope bolts 2 pcs silicone end caps (1pc with hole, 1pc without hole) 2 pcs white plastic anchors
AS-ND24D-E Round hoisting			Quantities 73set N.W 0.1KG Total weight 8.5KG Package size L468*W375*237	2 pcs thread locker 2 pcs side outlet aluminum end caps 2 pcs silicone end caps without hole 7 pcs screws 1 pcs plastic anchors 1 pc Phillips screwdriver
AS-ND24D-F Telescopic rod ceiling			Quantities 24set N.W 0.17KG Total weight 5.2KG Package size L400*W180*145	1 set of assembled telescopic rods (the telescopic distance can be adjusted between 300MM-600MM) 1 pc white plastic anchors 1 pc screw
AS-ND24D-G Steel Rope Ceiling			Quantities 146set N.W 0.05KG Total weight 8.5KG Package size L468*W375*237	1 pc 1.5m assembled steel rope (including 30MM round PC tube + 30MM PC clips + 2pcs opper bolts) 1 pc screw 1 pc white plastic anchors
AS-ND24D-H Wall Mounting			Quantities 73set N.W 0.09KG Total weight 7.7KG Package size L468*W375*237	1 pc Vertical Ceiling installation aluminum end cap 1 pcs fixed aluminum end cap 2 pcs silicone end caps (1pc with hole, 1pc without hole) 3 pcs 30MM PC clips 11 pcs screws 2 pcs white plastic anchors 1 pc Phillips screwdriver 1 pc M4 hexagonal wrench

# FND24D

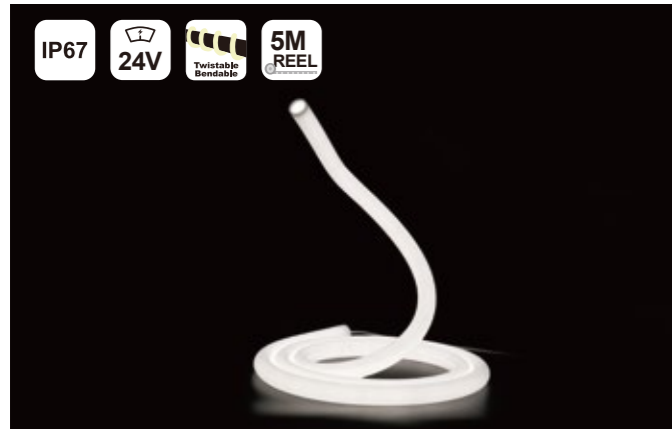

- Product size:  $\Phi 24\text{mm}$
- N.W.(G/M): 610g
- Material: Silicone
- Light transmittance: 75%
- Bending diameter:  $\Phi 100\text{mm}$
- Extrusion process: Dual color extrusion.
- 360° uniform light emission, without shadows.
- Application: Office/Home/Hotel/Exhibition/Hall.
- Suitable for diverse scenarios and creative designs.

WW NW CW

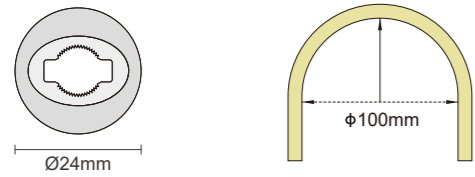

Recommended Accessories	
Silicone Endcap	One End Cap + One Plug Straight Outlet
Glue	10g/pcs

## Recommend LED strip parameters (Built-in COB Strip)

Series	Color	Lumen/M	Voltage	Power/M
FND24D	WW	1600	24V	28W
FND24D	NW	1680	24V	28W
FND24D	CW	1670	24V	28W

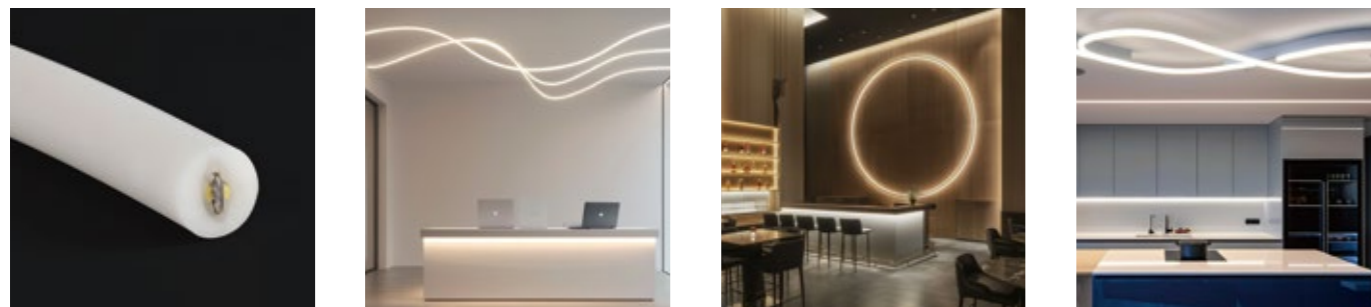
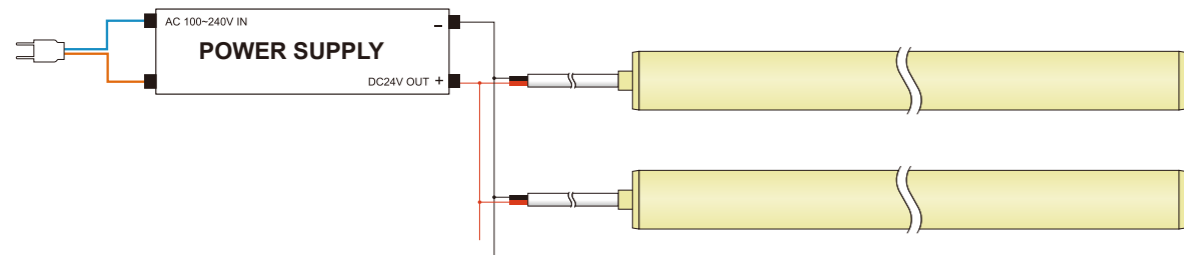

# ND14D

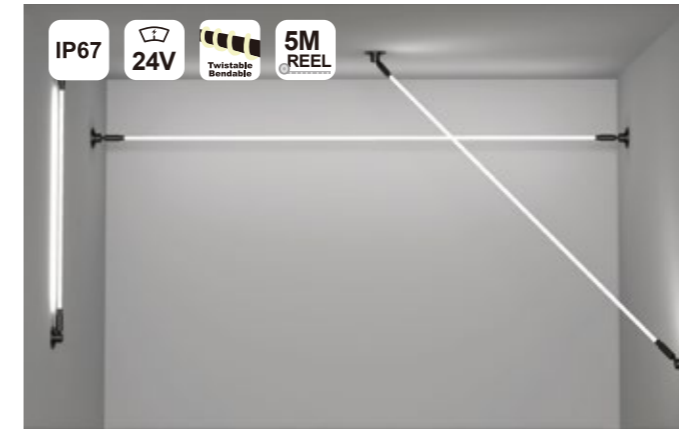

- Product size:  $\Phi 14\text{mm}$
- 360° uniform light emission, without shadows.
- Newly upgraded third-generation product, easy to install and beautiful in appearance.
- Can perfectly prevent the internal light strip from being damaged during installation.
- When in use, the product can be well suspended and straightened into a straight line.
- 360° plane rotating structure base + side 90° rotating structure, no need to consider the installation angle when installing.
- Application: Office/Home/Hotel/Exhibition/Hall.

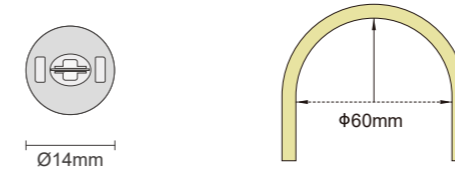

Recommended Accessories	
Neon Strip 5-10 Meters/Roll	
Ball Head Rod	
Base	
Solderless Connector	
Expansion Plug/Screw*6	
Tool	

## Recommend LED strip parameters

Series	Color	Lumen/M	Voltage	Power/M
ND14D	WW	700	24V	13W
ND14D	NW	740	24V	13W
ND14D	CW	720	24V	13W

WW NW CW

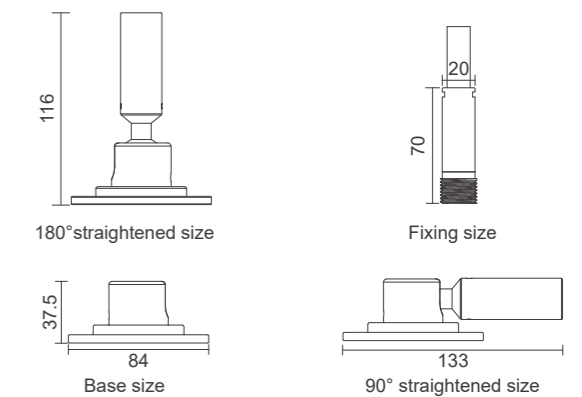
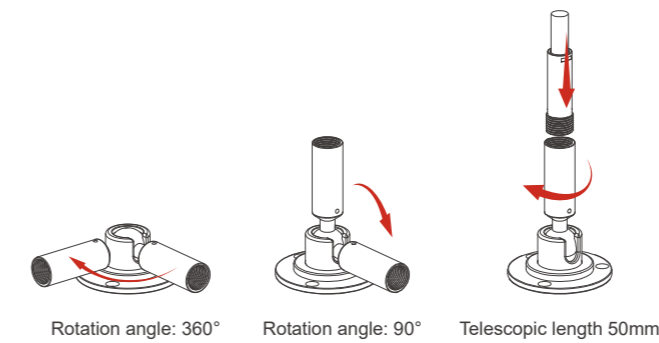

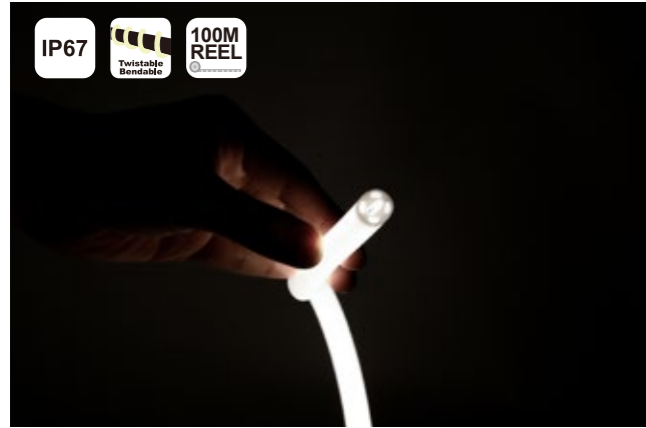

## ND13

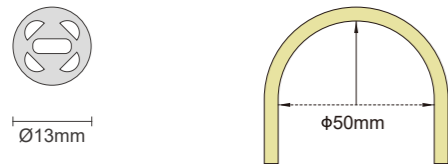

- Product size:  $\Phi 13\text{mm}$
- PCB width: 5-6mm
- Weight/Carton: 13.5KG
- Material: Silicone
- 360° uniform light emission, without shadows.
- Application: Office/Home/Hotel/Exhibition/Hall.
- Suitable for diverse scenarios and creative designs.
- Resistant to weather, corrosion, and UV exposure.
- Meets international standards for safety and reliability.



### Recommended Accessories

Mounting Clip	Plastic	
Silicone Endcap	One End Cap + One Plug Straight Outlet	
Glue	10g/pcs	

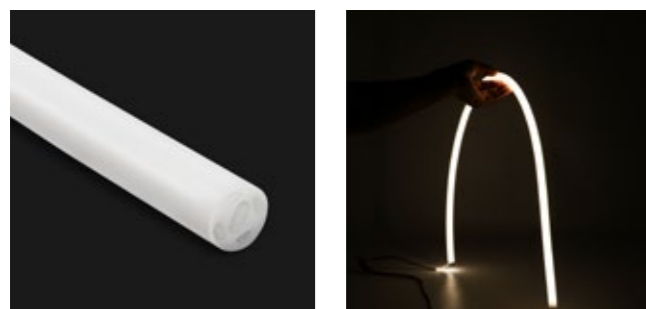



## ND16

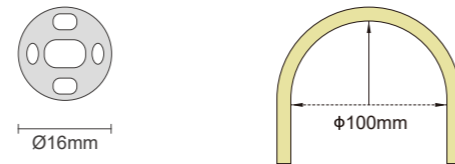

- Product size:  $\Phi 16\text{mm}$
- PCB width: 5-6mm
- Weight/Carton: 17.4KG
- Material: Silicone
- 360° uniform light emission, without shadows.
- Application: Office/Home/Hotel/Exhibition/Hall.
- Suitable for diverse scenarios and creative designs.
- Resistant to weather, corrosion, and UV exposure.
- Meets international standards for safety and reliability.



### Recommended Accessories

Mounting Clip	Plastic	
Silicone Endcap	One End Cap + One Plug Straight Outlet	
Glue	10g/pcs	





## ND20

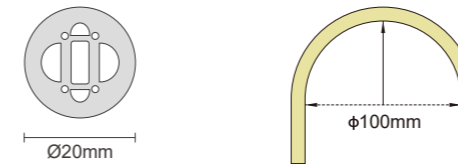

- Product size:  $\Phi 20\text{mm}$
- PCB width: 6-8mm
- Weight/Carton: 32KG
- Material: Silicone
- 360° uniform light emission, without shadows.
- Application: Office/Home/Hotel/Exhibition/Hall.
- Suitable for diverse scenarios and creative designs.
- Resistant to weather, corrosion, and UV exposure.
- Meets international standards for safety and reliability.



### Recommended Accessories

Mounting Clip	Plastic	
Silicone Endcap	One End Cap + One Plug Straight Outlet	
Glue	10g/pcs	

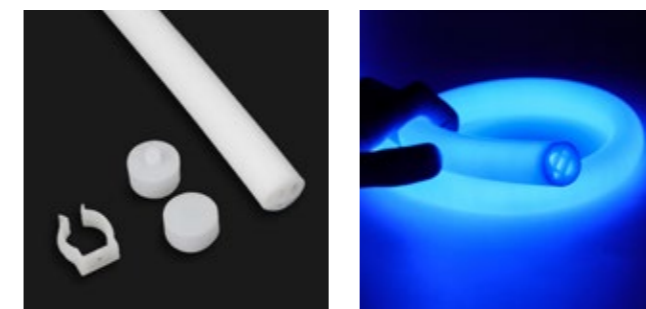



## ND22

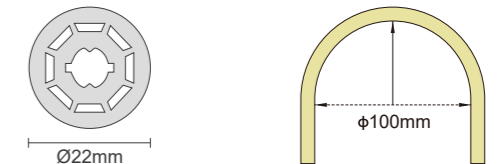

- Product size:  $\Phi 22\text{mm}$
- PCB width: 8mm
- Weight/Carton: 32KG
- Material: Silicone
- 360° uniform light emission, without shadows.
- Application: Office/Home/Hotel/Exhibition/Hall.
- Suitable for diverse scenarios and creative designs.
- Resistant to weather, corrosion, and UV exposure.
- Meets international standards for safety and reliability.



### Recommended Accessories

Mounting Clip	Plastic	
Silicone Endcap	One End Cap + One Plug Straight Outlet	
Glue	10g/pcs	

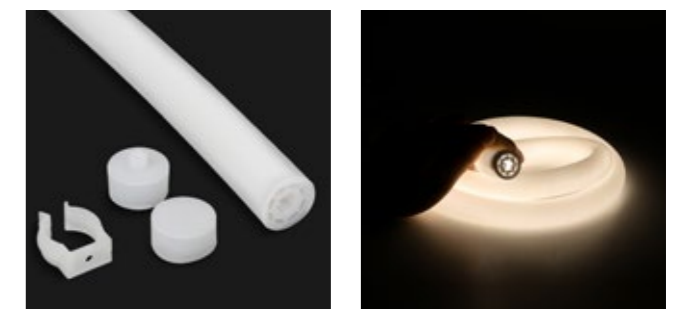

## ND26



- Product size:  $\Phi 26\text{mm}$
- PCB width: 10mm
- Weight/Carton: 44.5KG
- Material: Silicone
- 360° uniform light emission, without shadows.
- Application: Office/Home/Hotel/Exhibition/Hall.
- Suitable for diverse scenarios and creative designs.
- Resistant to weather, corrosion, and UV exposure.
- Meets international standards for safety and reliability.

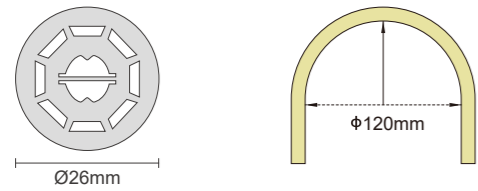

### Recommended Accessories

Silicone Endcap	One End Cap + One Plug Straight Outlet	
Glue	10g/pcs	

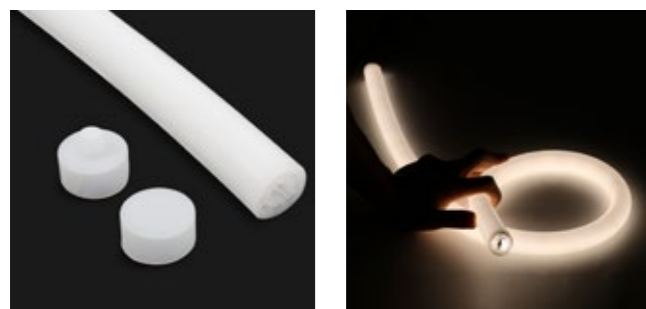

## ND33



- Product size:  $\Phi 33\text{mm}$
- PCB width: 8mm
- Weight/Carton: 36.5KG
- Material: Silicone
- 360° uniform light emission, without shadows.
- Application: Office/Home/Hotel/Exhibition/Hall.
- Suitable for diverse scenarios and creative designs.
- Resistant to weather, corrosion, and UV exposure.
- Meets international standards for safety and reliability.

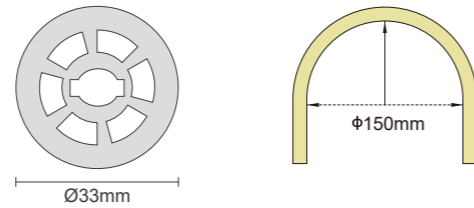

### Recommended Accessories

Silicone Endcap	One End Cap + One Plug Straight Outlet	
Glue	10g/pcs	

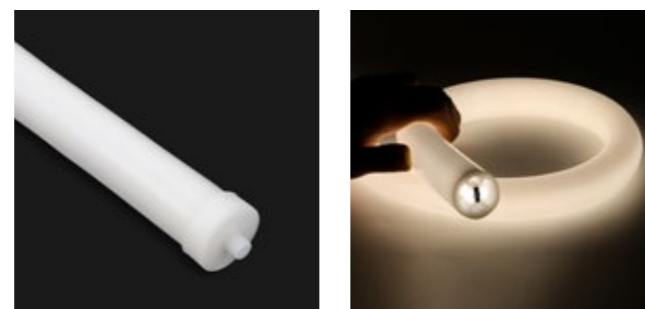

## ND40



- Product size:  $\Phi 40\text{mm}$
- PCB width: 8mm
- Weight/Carton: 49.8KG
- Material: Silicone
- 360° uniform light emission, without shadows.
- Application: Office/Home/Hotel/Exhibition/Hall.
- Suitable for diverse scenarios and creative designs.
- Resistant to weather, corrosion, and UV exposure.
- Meets international standards for safety and reliability.

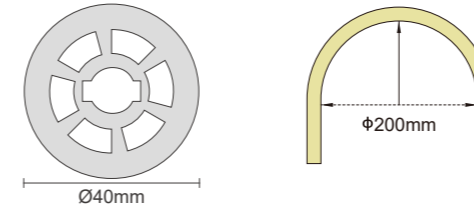

### Recommended Accessories

Silicone Endcap	One End Cap + One Plug Straight Outlet	
Glue	10g/pcs	

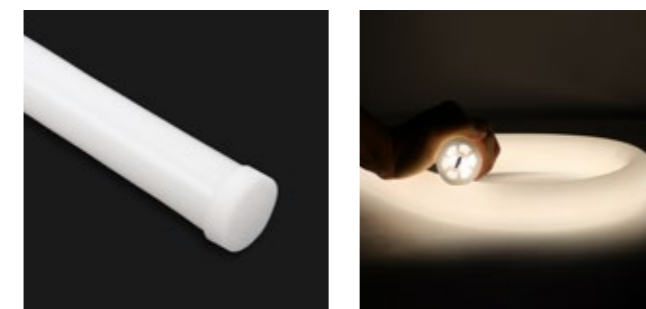



## Rectangle Neon Silicone Tube



## N2010



- Product size: 20\*10mm
- PCB width: 10-12mm
- Weight/Carton: 21.5KG
- Material: Silicone
- Length: 100M/reel, Customized
- Dotless and beautiful lighting
- Suitable for diverse scenarios and creative designs.
- Resistant to weather, corrosion, and UV exposure.
- Meets international standards for safety and reliability.

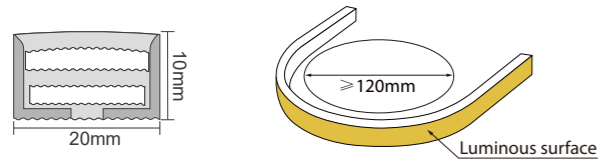

### Recommended Accessories

Mounting Clip	30mm/pc With Screws	
Silicone Endcap	One End Cap + One Plug Straight Outlet	
Glue	10g/pcs	



## N2014



- Product size: 20\*14mm
- PCB width: 12-15mm
- Weight/Carton: 23.8KG
- Material: Silicone
- Length: 100M/reel, Customized
- Dotless and beautiful lighting
- Suitable for diverse scenarios and creative designs.
- Resistant to weather, corrosion, and UV exposure.
- Meets international standards for safety and reliability.

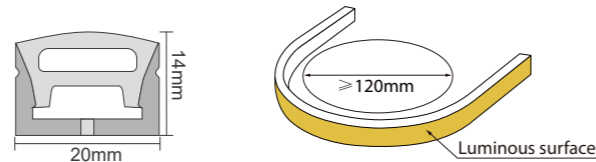

### Recommended Accessories

Mounting Clip	30mm/pc With Screws	
Silicone Endcap	One End Cap + One Plug Straight Outlet	
Glue	10g/pcs	

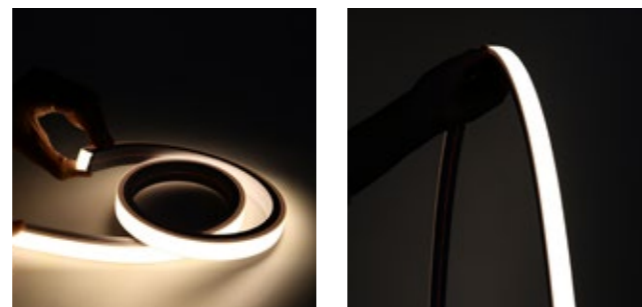

## N2020

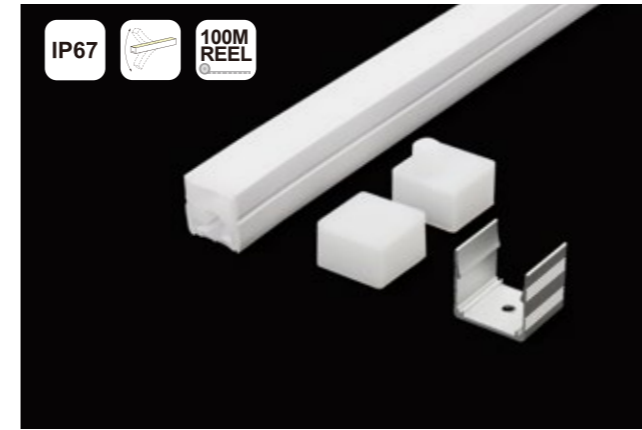

- Product size: 20\*20mm
- PCB width: 10-12mm
- Weight/Carton: 30.5KG
- Material: Silicone
- Length: 100M/reel, Customized
- Dotless and beautiful lighting
- Suitable for diverse scenarios and creative designs.
- Resistant to weather, corrosion, and UV exposure.
- Meets international standards for safety and reliability.

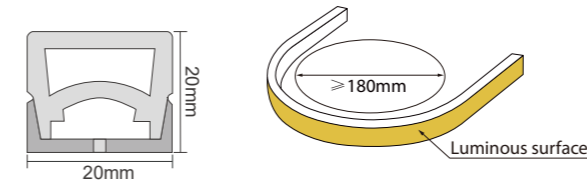

### Recommended Accessories

Mounting Clip	30mm/pc With Screws	
Silicone Endcap	One End Cap + One Plug Straight Outlet	
Glue	10g/pcs	

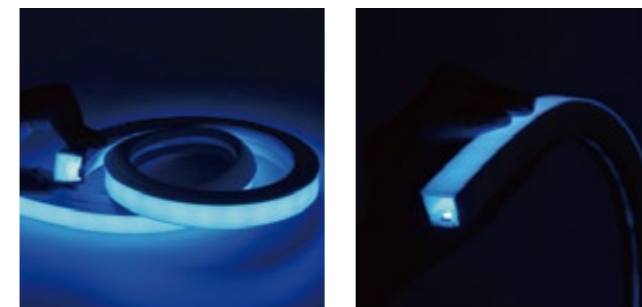

## N3020

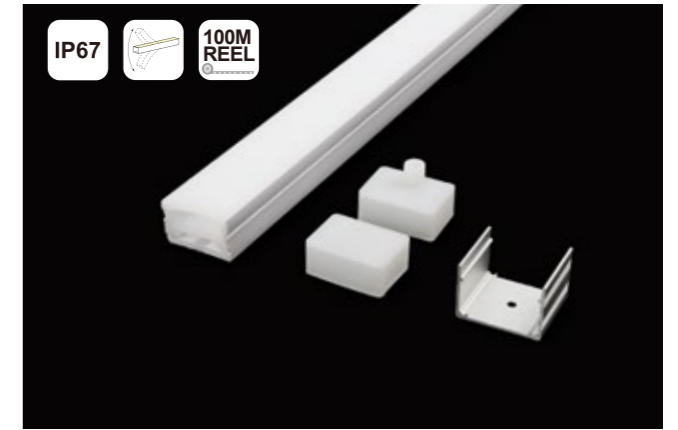

- Product size: 30\*20mm
- PCB width: 16-18mm
- Weight/Carton: 44.5KG
- Material: Silicone
- Length: 100M/reel, Customized
- Dotless and beautiful lighting
- Suitable for diverse scenarios and creative designs.
- Resistant to weather, corrosion, and UV exposure.
- Meets international standards for safety and reliability.

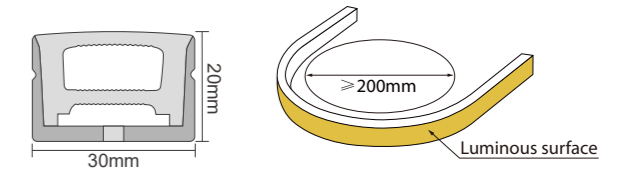

### Recommended Accessories

Mounting Clip	30mm/pc With Screws	
Silicone Endcap	One End Cap + One Plug Straight Outlet	
Glue	10g/pcs	



## N5025



- Product size: 50\*25mm
- PCB width: 18-20mm
- Weight/Carton: 34.5KG
- Material: Silicone
- Length: 50M/reel, Customized
- Dotless and beautiful lighting
- Suitable for diverse scenarios and creative designs.
- Resistant to weather, corrosion, and UV exposure.
- Meets international standards for safety and reliability.

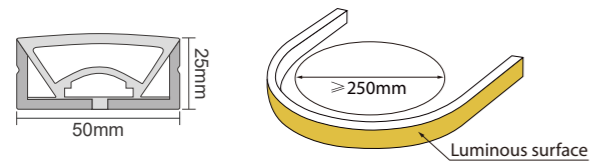

### Recommended Accessories

Mounting Clip	30mm/pc With Screws	
Silicone Endcap	One End Cap + One Plug Straight Outlet	
Glue	10g/pcs	



## N0410B

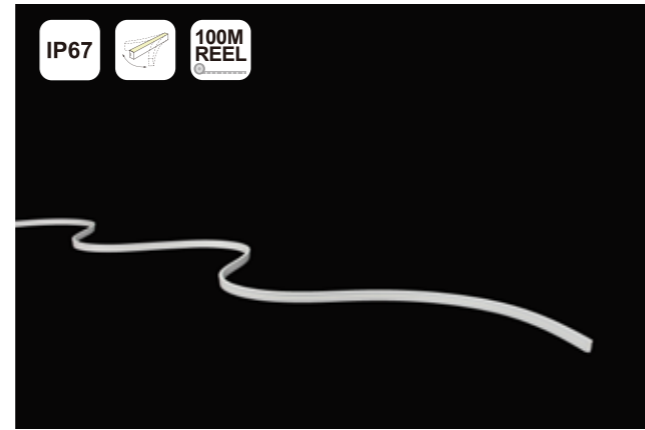

- Product size: 4\*10mm
- PCB width: 4-7mm
- N.W.(G/M): 45g
- Material: Silicone
- Length: 100M/reel, Customized
- Dotless and beautiful lighting
- Suitable for diverse scenarios and creative designs.
- Resistant to weather, corrosion, and UV exposure.
- Meets international standards for safety and reliability.

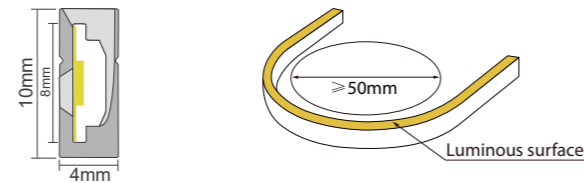

### Recommended Accessories

Mounting Clip	Plastic With Screws	
Silicone Endcap	One End Cap + One Plug Straight Outlet	
Silicone Endcap	One End Cap + One Plug Side Outlet	
Glue	10g/pcs	



## N0513



- Product size: 5\*13mm
- PCB width: 8-10mm
- N.W.(G/M): 60g
- Material: Silicone
- Length: 100M/reel, Customized
- Dotless and beautiful lighting
- Suitable for diverse scenarios and creative designs.
- Resistant to weather, corrosion, and UV exposure.
- Meets international standards for safety and reliability.

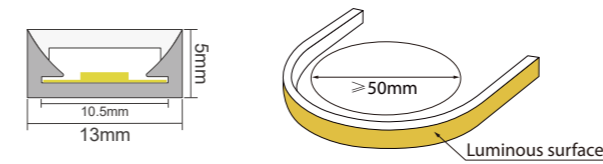

### Recommended Accessories

Silicone Endcap	One End Cap + One Plug Straight Outlet	
Glue	10g/pcs	



## N1326



- Product size: 13\*26mm
- PCB width: 10-12mm
- N.W.(G/M): 300g
- Material: Silicone
- Length: 50M/reel, Customized
- Dotless and beautiful lighting
- Suitable for diverse scenarios and creative designs.
- Resistant to weather, corrosion, and UV exposure.
- Meets international standards for safety and reliability.

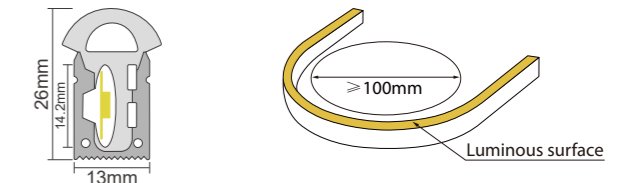

### Recommended Accessories

Mounting Clip	30mm/pc With Screws	
Silicone Endcap	One End Cap + One Plug Straight Outlet	
Silicone Endcap	One End Cap + One Plug Side Outlet	
Glue	10g/pcs	

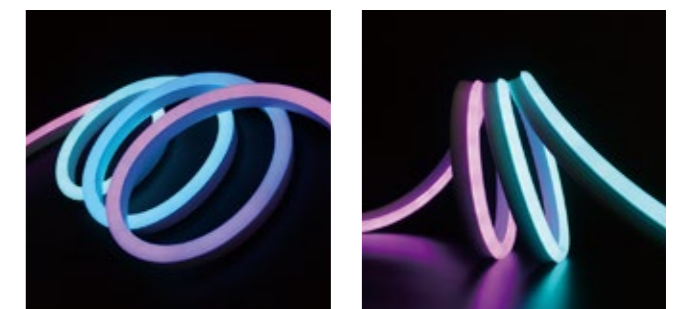

## N2515



- Product size: 25\*15mm
- PCB width: 15-18mm
- N.W.(G/M): 295g
- Material: Silicone
- Length: 50M/reel, Customized
- Dotless and beautiful lighting
- Suitable for diverse scenarios and creative designs.
- Resistant to weather, corrosion, and UV exposure.
- Meets international standards for safety and reliability.

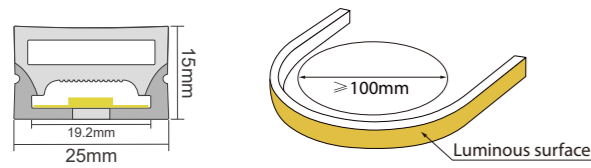

### Recommended Accessories

Mounting Clip	30mm/pc With Screws	
Silicone Endcap	One End Cap + One Plug Straight Outlet	
Silicone Endcap	One End Cap + One Plug Bottom Outlet	
Glue	10g/pcs	



## N0612P



- Product size: 6\*12mm
- PCB width: 8mm
- N.W.(G/M): 75g
- Material: Silicone
- Length: 100M/reel, Customized
- Dotless and beautiful lighting
- Suitable for diverse scenarios and creative designs.
- Resistant to weather, corrosion, and UV exposure.
- Meets international standards for safety and reliability.

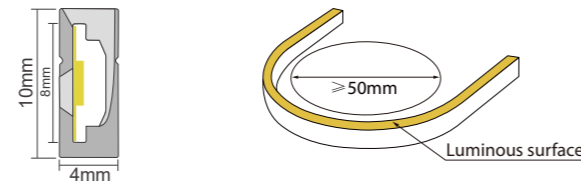

### Recommended Accessories

Mounting Clip	30mm/pc With Screws	
Silicone Endcap	One End Cap + One Plug Straight Outlet	
Silicone Endcap	One End Cap + One Plug Bottom Outlet	
Silicone Endcap	One End Cap + One Plug Side Outlet	
Glue	10g/pcs	

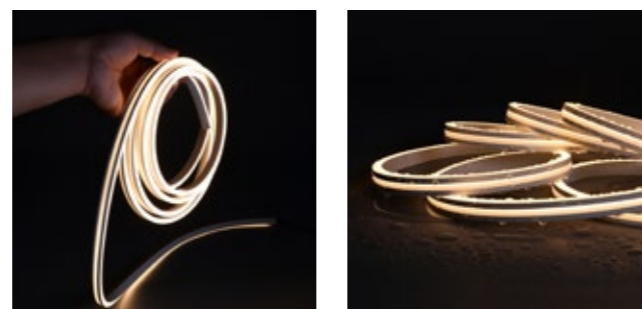

## N0816P



- Product size: 8\*16mm
- PCB width: 8mm
- N.W.(G/M): 145g
- Material: Silicone
- Length: 100M/reel, Customized
- Dotless and beautiful lighting
- Suitable for diverse scenarios and creative designs.
- Resistant to weather, corrosion, and UV exposure.
- Meets international standards for safety and reliability.

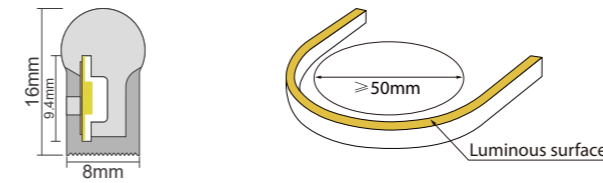

### Recommended Accessories

Mounting Clip	30mm/pc With Screws	
Silicone Endcap	One End Cap + One Plug Straight Outlet	
Glue	10g/pcs	

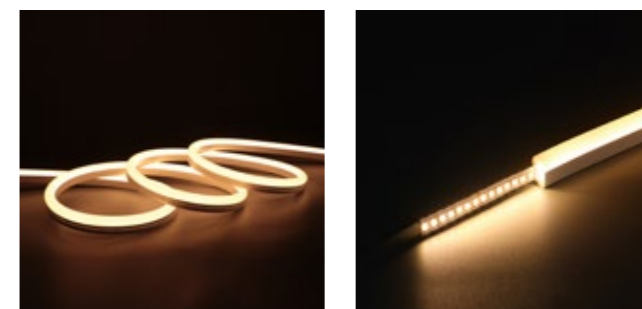

## N1010P-TOP



- Product size: 10\*10mm
- PCB width: 5mm
- N.W.(G/M): 120g
- Material: Silicone
- Length: 100M/reel, Customized
- Dotless and beautiful lighting
- Suitable for diverse scenarios and creative designs.
- Resistant to weather, corrosion, and UV exposure.
- Meets international standards for safety and reliability.

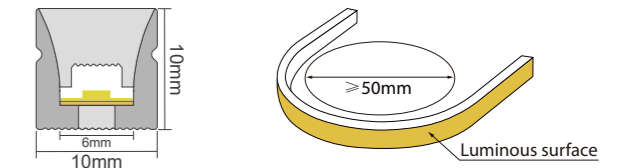

### Recommended Accessories

Mounting Clip	30mm/pc With Screws	
Silicone Endcap	One End Cap + One Plug Straight Outlet	
Silicone Endcap	One End Cap + One Plug Bottom Outlet	
Silicone Endcap	One End Cap + One Plug Side Outlet	
Glue	10g/pcs	





## N1010P-SIDE



- Product size: 10\*10mm
- PCB width: 5mm
- N.W.(G/M): 120g
- Material: Silicone
- Length: 100M/reel, Customized
- Dotless and beautiful lighting
- Suitable for diverse scenarios and creative designs.
- Resistant to weather, corrosion, and UV exposure.
- Meets international standards for safety and reliability.

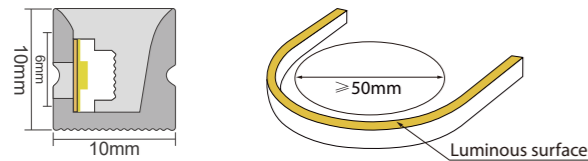

### Recommended Accessories

Mounting Clip	30mm/pc With Screws	
Silicone Endcap	One End Cap + One Plug Straight Outlet	
Silicone Endcap	One End Cap + One Plug Bottom Outlet	
Silicone Endcap	One End Cap + One Plug Side Outlet	
Glue	10g/pcs	

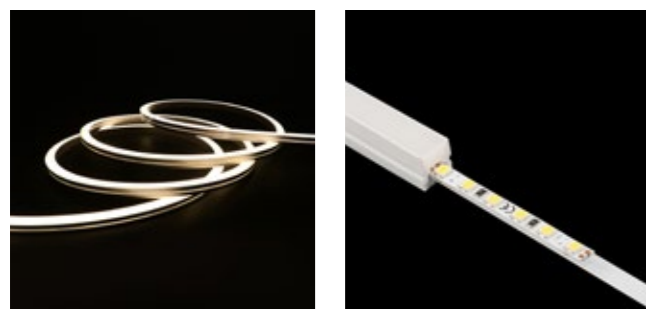

## N1020P



- Product size: 10\*20mm
- PCB width: 10mm
- N.W.(G/M): 250g
- Material: Silicone
- Length: 100M/reel, Customized
- Dotless and beautiful lighting
- Suitable for diverse scenarios and creative designs.
- Resistant to weather, corrosion, and UV exposure.
- Meets international standards for safety and reliability.

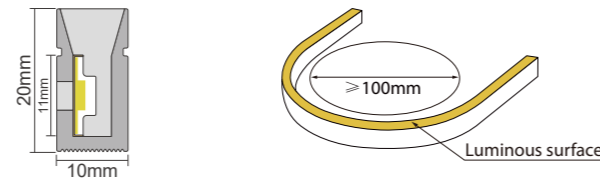

### Recommended Accessories

Mounting Clip	30mm/pc With Screws	
Silicone Endcap	One End Cap + One Plug Straight Outlet	
Silicone Endcap	One End Cap + One Plug Bottom Outlet	
Silicone Endcap	One End Cap + One Plug Side Outlet	
Glue	10g/pcs	

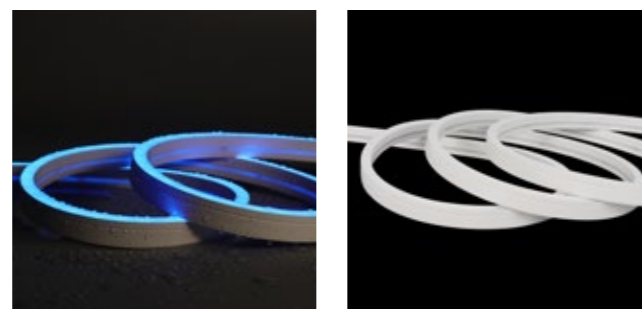

## N1023P



- Product size: 10\*23mm
- PCB width: 10mm
- N.W.(G/M): 250g
- Material: Silicone
- Length: 50M/reel, Customized
- Dotless and beautiful lighting
- Suitable for diverse scenarios and creative designs.
- Resistant to weather, corrosion, and UV exposure.
- Meets international standards for safety and reliability.

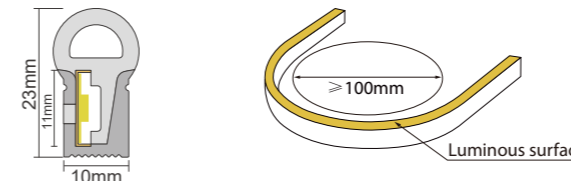

### Recommended Accessories

Mounting Clip	30mm/pc With Screws	
Silicone Endcap	One End Cap + One Plug Straight Outlet	
Silicone Endcap	One End Cap + One Plug Bottom Outlet	
Silicone Endcap	One End Cap + One Plug Side Outlet	
Glue	10g/pcs	



## N1220P



- Product size: 12\*20mm
- PCB width: 10mm
- N.W.(G/M): 250g
- Material: Silicone
- Length: 50M/reel, Customized
- Dotless and beautiful lighting
- Suitable for diverse scenarios and creative designs.
- Resistant to weather, corrosion, and UV exposure.
- Meets international standards for safety and reliability.

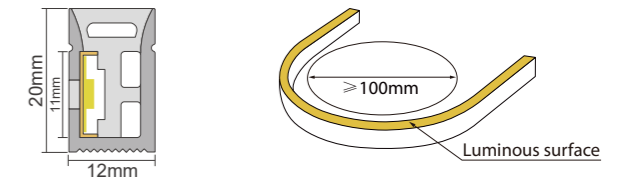

### Recommended Accessories

Mounting Clip	30mm/pc With Screws	
Silicone Endcap	One End Cap + One Plug Straight Outlet	
Silicone Endcap	One End Cap + One Plug Bottom Outlet	
Silicone Endcap	One End Cap + One Plug Side Outlet	
Glue	10g/pcs	



# N1615P





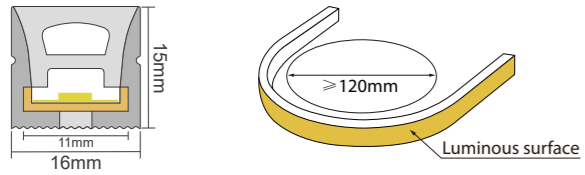

IP67 50M REEL

- Product size: 16\*15mm
- PCB width: 10mm
- N.W.(G/M): 260g
- Material: Silicone
- Length: 50M/reel, Customized
- Dotless and beautiful lighting
- Suitable for diverse scenarios and creative designs.
- Resistant to weather, corrosion, and UV exposure.
- Meets international standards for safety and reliability.



## Recommended Accessories

Mounting Clip	30mm/pc With Screws	
Silicone Endcap	One End Cap + One Plug Straight Outlet	
Silicone Endcap	One End Cap + One Plug Bottom Outlet	
Silicone Endcap	One End Cap + One Plug Side Outlet	
Glue	10g/pcs	

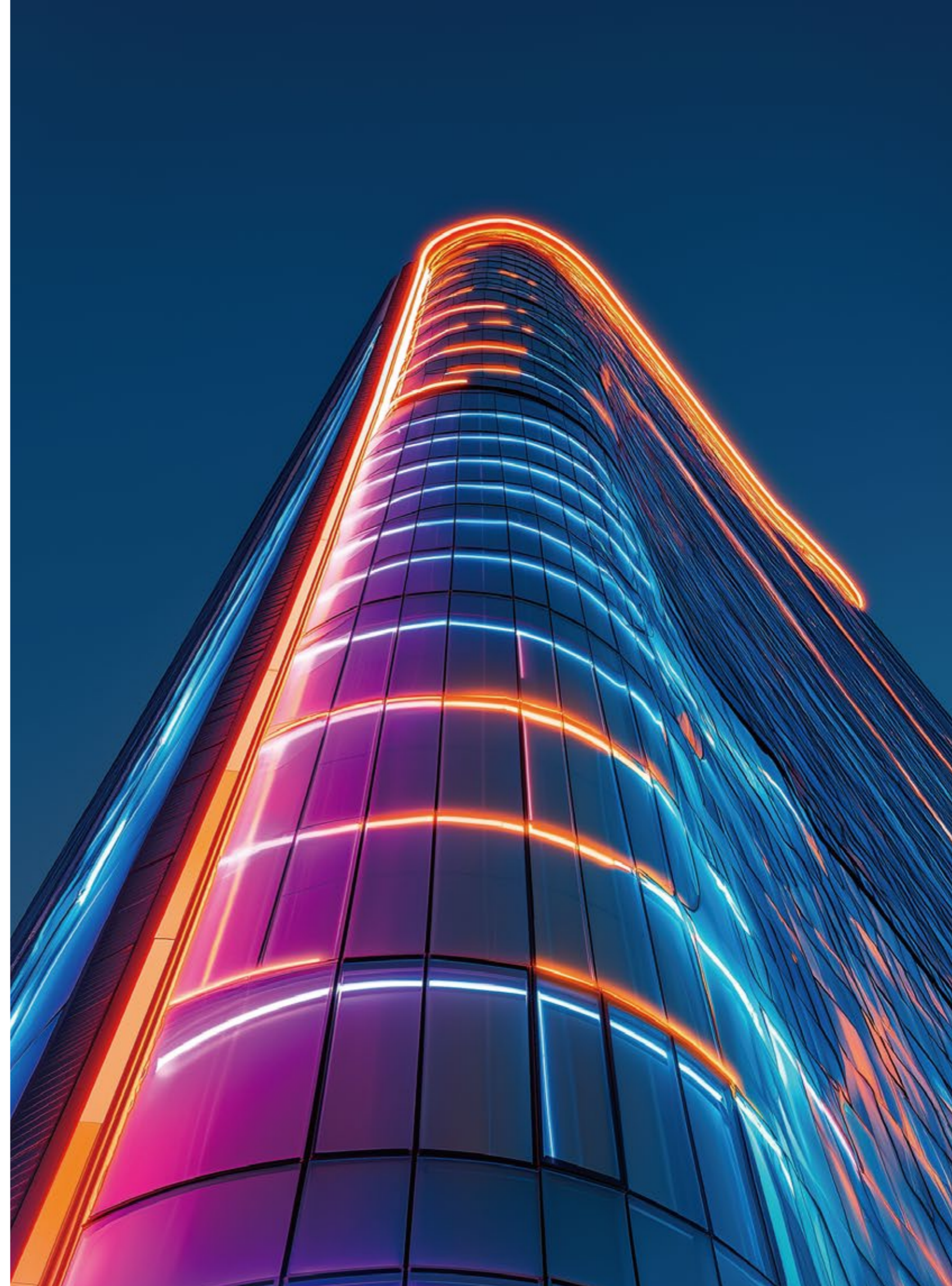
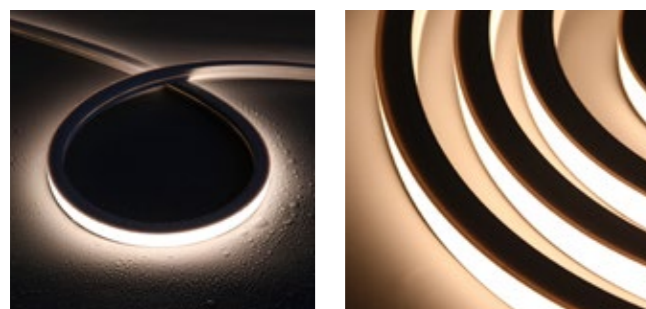



## Rectangle Neon Silicone Cover



## NC1010



- Product size: 10\*10mm
- PCB width: 5mm
- Material: Silicone
- Length: 100M/reel, Customized
- Support OEM & ODM
- Dotless and beautiful lighting
- Suitable for diverse scenarios and creative designs.
- Resistant to weather, corrosion, and UV exposure.
- Meets international standards for safety and reliability.

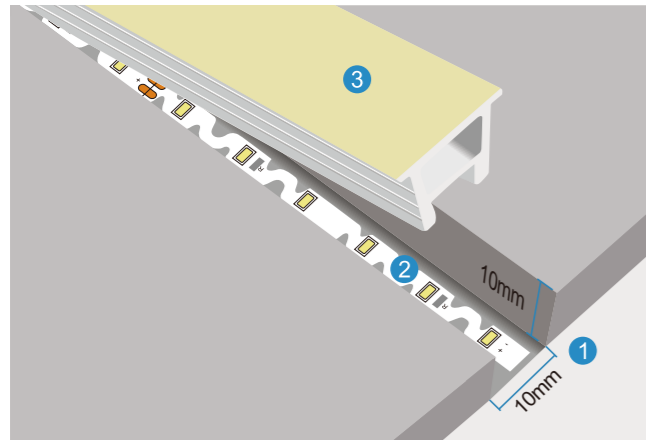
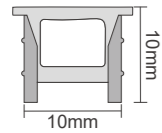

- 1 Slot according to the size, the error should be small
- 2 Tear off double-sided tape at back and stick the light strip to the wall
- 3 Press the cover into the wall. When the light is turned on, the cover has high light transmittance and high temperature resistance. The light strip and the cover are installed separately, which makes the DIY operation space more

## NC1212



- Product size: 12\*12mm
- PCB width: 8mm
- Material: Silicone
- Length: 100M/reel, Customized
- Support OEM & ODM
- Dotless and beautiful lighting
- Suitable for diverse scenarios and creative designs.
- Resistant to weather, corrosion, and UV exposure.
- Meets international standards for safety and reliability.

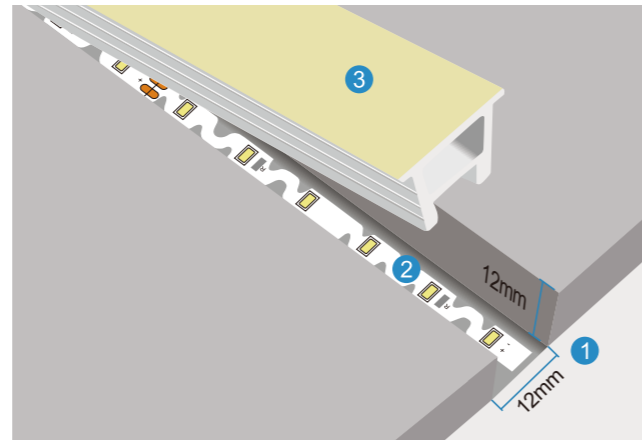
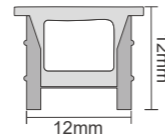

- 1 Slot according to the size, the error should be small
- 2 Tear off double-sided tape at back and stick the light strip to the wall
- 3 Press the cover into the wall. When the light is turned on, the cover has high light transmittance and high temperature resistance. The light strip and the cover are installed separately, which makes the DIY operation space more

## NC1616



- Product size: 16\*16mm
- PCB width: 10-12mm
- Material: Silicone
- Length: 100M/reel, Customized
- Support OEM & ODM
- Dotless and beautiful lighting
- Suitable for diverse scenarios and creative designs.
- Resistant to weather, corrosion, and UV exposure.
- Meets international standards for safety and reliability.

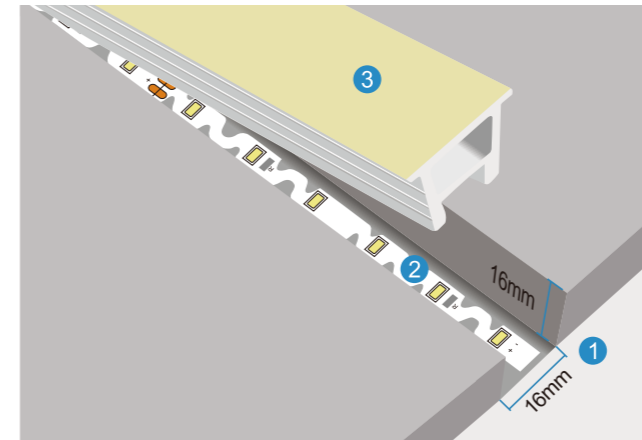
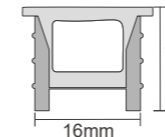

- 1 Slot according to the size, the error should be small
- 2 Tear off double-sided tape at back and stick the light strip to the wall
- 3 Press the cover into the wall. When the light is turned on, the cover has high light transmittance and high temperature resistance. The light strip and the cover are installed separately, which makes the DIY operation space more

## NC2010



- Product size: 20\*10mm
- PCB width: 10-15mm
- Material: Silicone
- Length: 100M/reel, Customized
- Support OEM & ODM
- Dotless and beautiful lighting
- Suitable for diverse scenarios and creative designs.
- Resistant to weather, corrosion, and UV exposure.
- Meets international standards for safety and reliability.

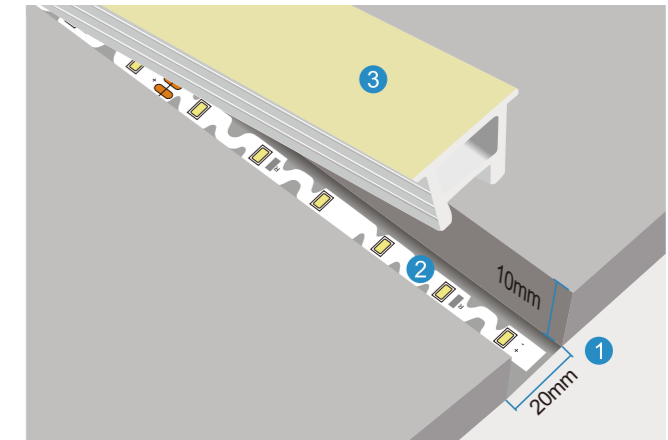
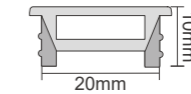

- 1 Slot according to the size, the error should be small
- 2 Tear off double-sided tape at back and stick the light strip to the wall
- 3 Press the cover into the wall. When the light is turned on, the cover has high light transmittance and high temperature resistance. The light strip and the cover are installed separately, which makes the DIY operation space more

## NC2014



- Product size: 20\*14mm
- PCB width: 10-15mm
- Material: Silicone
- Length: 100M/reel, Customized
- Support OEM & ODM
- Dotless and beautiful lighting
- Suitable for diverse scenarios and creative designs.
- Resistant to weather, corrosion, and UV exposure.
- Meets international standards for safety and reliability.

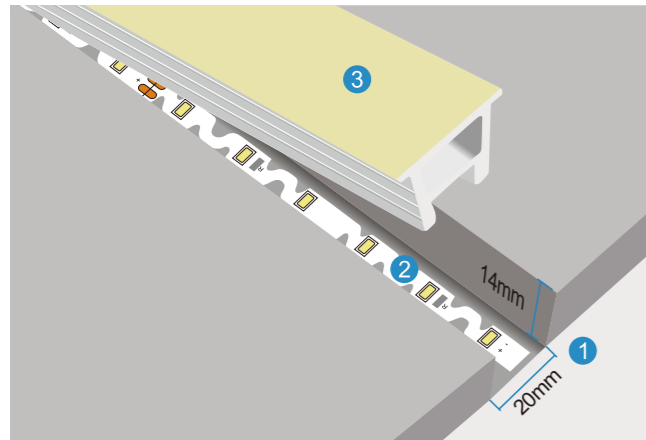
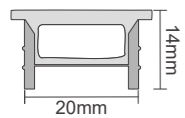

- 1 Slot according to the size, the error should be small
- 2 Tear off double-sided tape at back and stick the light strip to the wall
- 3 Press the cover into the wall. When the light is turned on, the cover has high light transmittance and high temperature resistance. The light strip and the cover are installed separately, which makes the DIY operation space more

## NC2018



- Product size: 20\*18mm
- PCB width: 10-15mm
- Material: Silicone
- Length: 100M/reel, Customized
- Support OEM & ODM
- Dotless and beautiful lighting
- Suitable for diverse scenarios and creative designs.
- Resistant to weather, corrosion, and UV exposure.
- Meets international standards for safety and reliability.

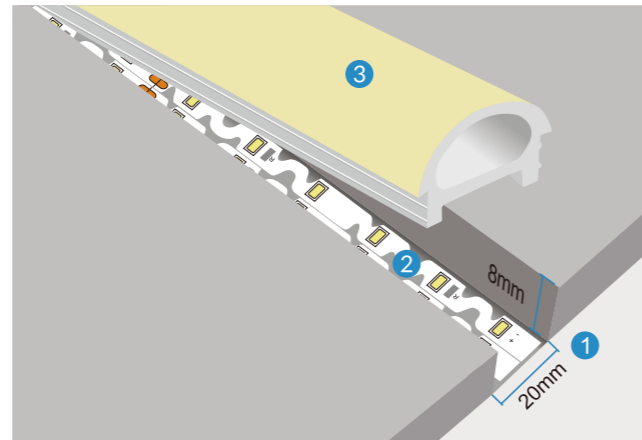
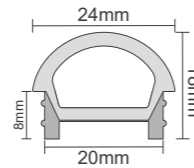

- 1 Slot according to the size, the error should be small
- 2 Tear off double-sided tape at back and stick the light strip to the wall
- 3 Press the cover into the wall. When the light is turned on, the cover has high light transmittance and high temperature resistance. The light strip and the cover are installed separately, which makes the DIY operation space more

## NC2020

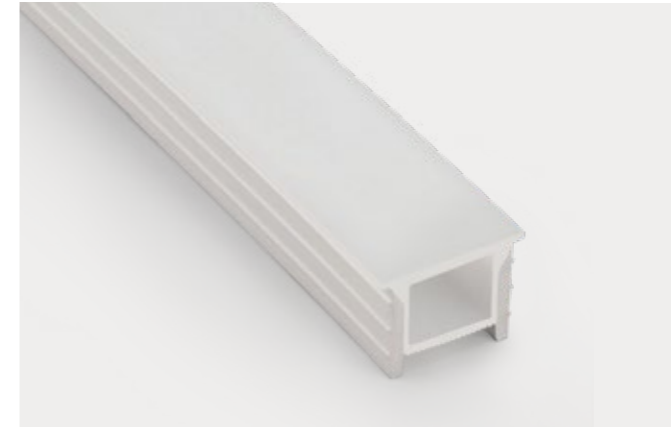

- Product size: 20\*20mm
- PCB width: 10-15mm
- Material: Silicone
- Length: 100M/reel, Customized
- Support OEM & ODM
- Dotless and beautiful lighting
- Suitable for diverse scenarios and creative designs.
- Resistant to weather, corrosion, and UV exposure.
- Meets international standards for safety and reliability.

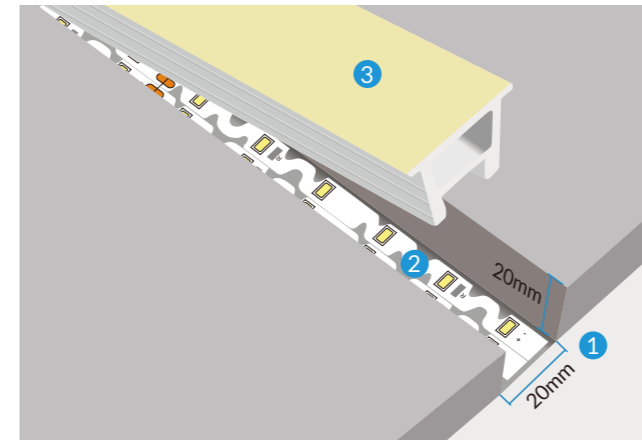
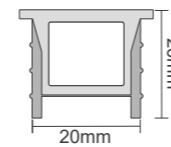

- 1 Slot according to the size, the error should be small
- 2 Tear off double-sided tape at back and stick the light strip to the wall
- 3 Press the cover into the wall. When the light is turned on, the cover has high light transmittance and high temperature resistance. The light strip and the cover are installed separately, which makes the DIY operation space more

## NC3020



- Product size: 30\*20mm
- PCB width: 10-20mm
- Material: Silicone
- Length: 100M/reel, Customized
- Support OEM & ODM
- Dotless and beautiful lighting
- Suitable for diverse scenarios and creative designs.
- Resistant to weather, corrosion, and UV exposure.
- Meets international standards for safety and reliability.

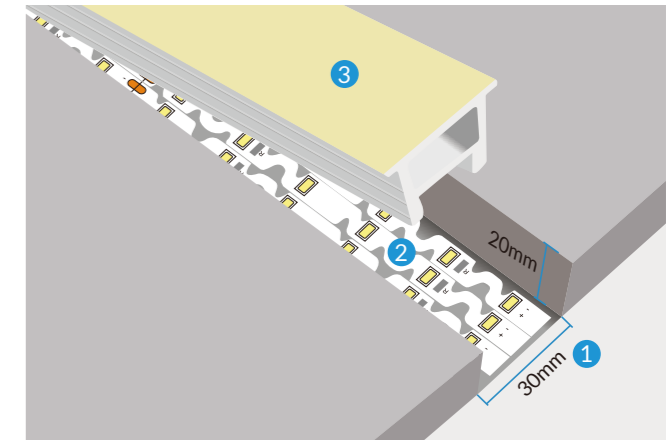
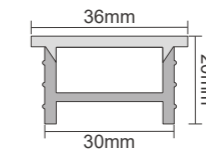

- 1 Slot according to the size, the error should be small
- 2 Tear off double-sided tape at back and stick the light strip to the wall
- 3 Press the cover into the wall. When the light is turned on, the cover has high light transmittance and high temperature resistance. The light strip and the cover are installed separately, which makes the DIY operation space more