



FCOB630-24-M10-RGB
FLEXIBLE STRIP INTRODUCTION

Product specification

Lister: 钟敬萍

Assessor: 张明

Approver: 李春

Features:

- 1) New Flip Chip On Board Flexible LED Strip, 630chips per meter.
- 2) Ideal for LED lighting application to avoid multi-shadows.
- 3) Higher heat conductivity for better thermal management.
- 4) Provide variable and innovative array LED layout designs and combinations.

- Available in 24V DC maximum.
- Very bright & low power consumption.
- Operating temperature: -20~40°C.
- Long life span LED lights, more than 50,000 hours.
- Adhesive back, peel & stick!
- All available controller or dimmers.
- Non-waterproof, IP20.

IP20

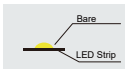

IP67

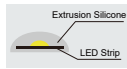

IP68

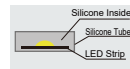

Assembly drawing

Top View

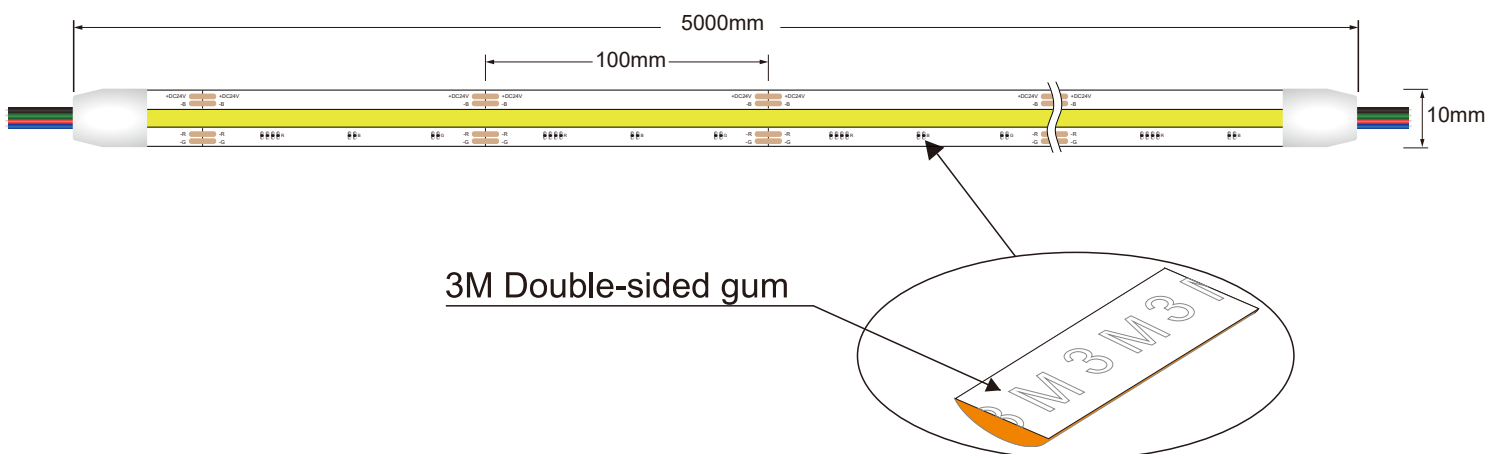

Section



FCOB630-24-M10-RGB								
Part number	Size (mm)	Color	Cut Every	Chips/M	Lumen/M	Voltage	Power/M	Package
FCOB630-24-M10-RGB	L5000*W10*H1.6	Red ■	100mm	630	107.5	24V	9W	5Meters/Reel
		Green ■			276			
		Blue ■			34.5			

Application

Ideal for sign letters and channel letters, concealed lights, room lighting, equipment.



LED Light distribution

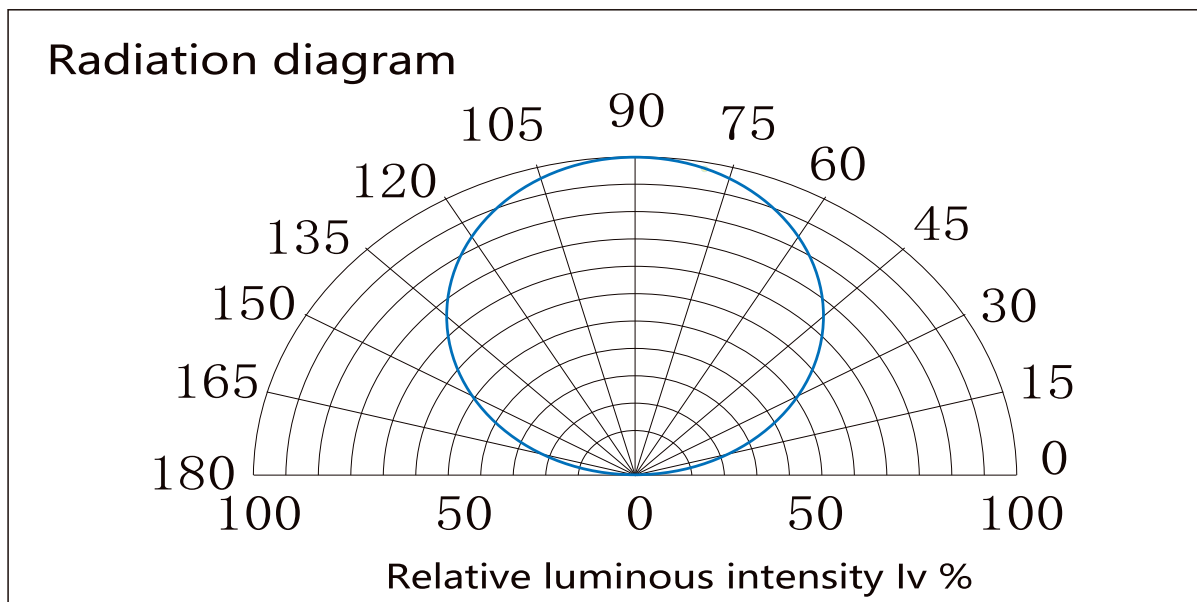

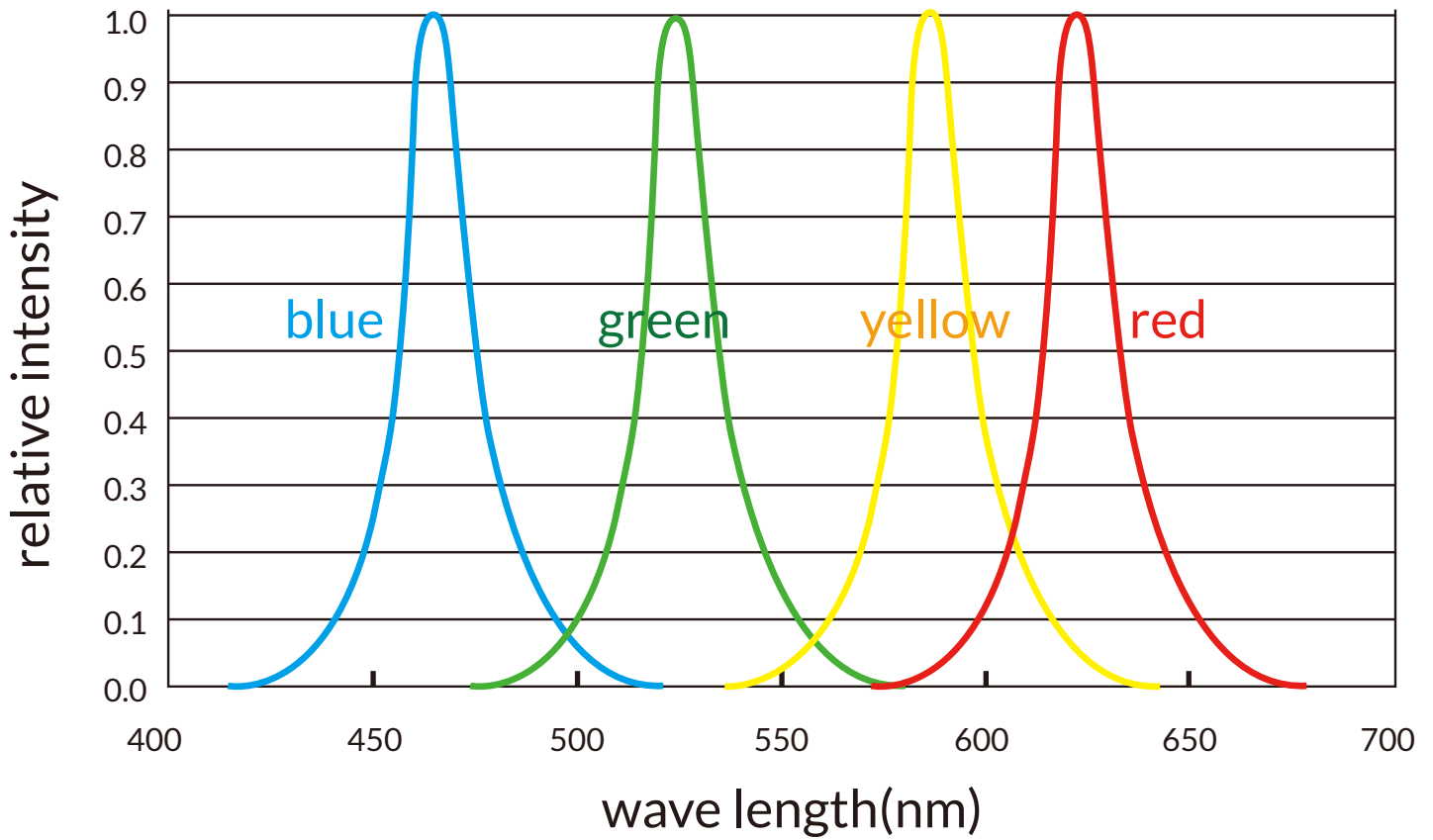

Package:



Package: 5 meters strip in one reel, one reel in one anti-static bag, 25 bags put into one carton, 2 inner boxes put into 1 carton .

How to connect flexible strip

Below shows you how to connect the flexible strip to power supplies.

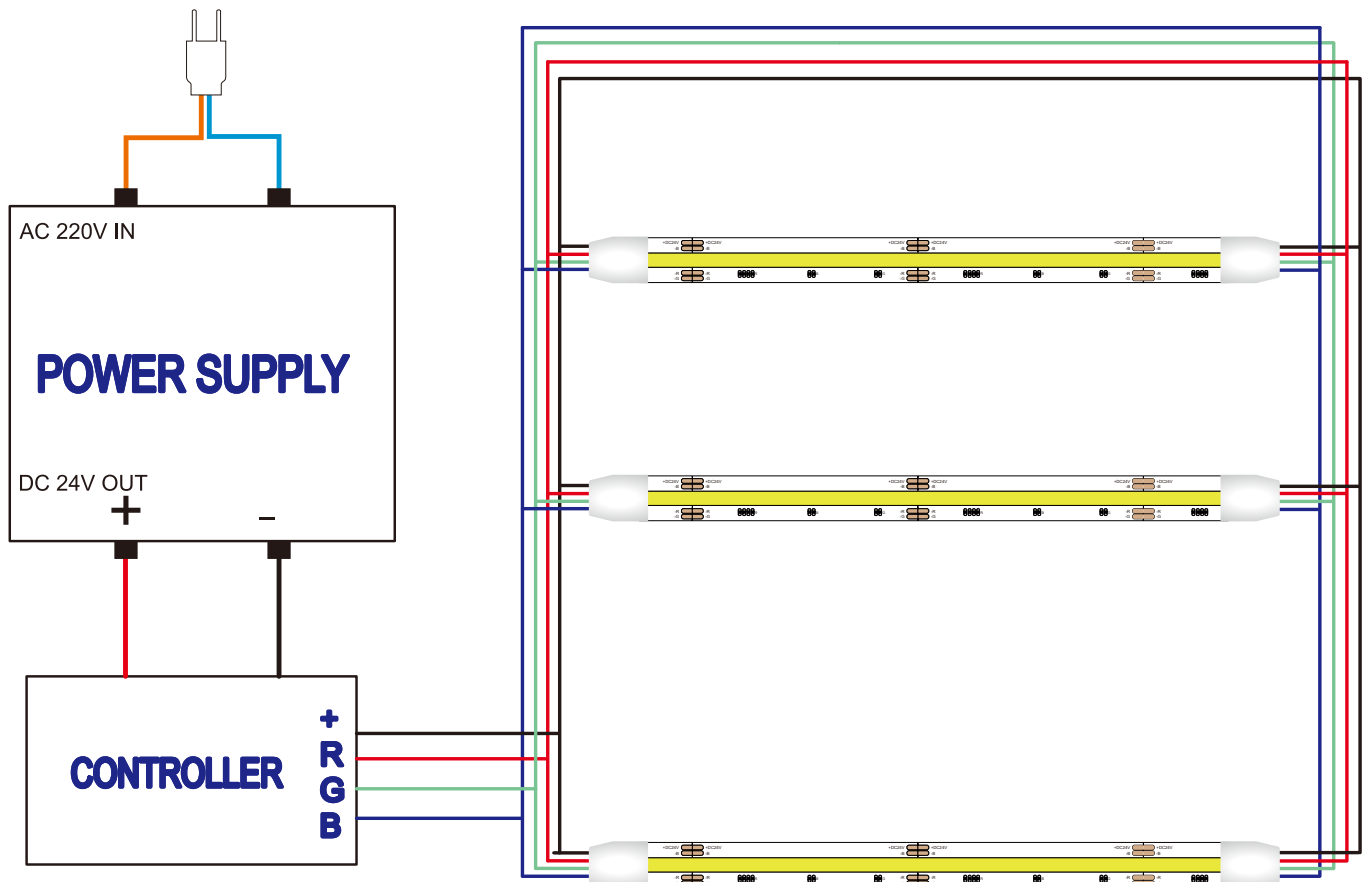

Note:

Please note that, the LED strips should not be used in sealed or hot place, to make sure the heat Dispersion is good for the LEDs.

Each flexible strip with a total length of the series can not be more than 5 meters.

Flexible strip with all of the total power can not exceed 90% of the power switching power supply.

! Cautions:

When install the led strip, please note the installation technique. The led strip can be bent, but not distorted, as shown below:

Distortion(Wrong)

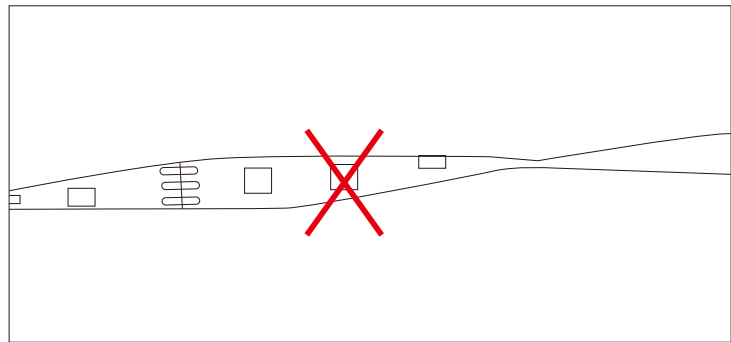
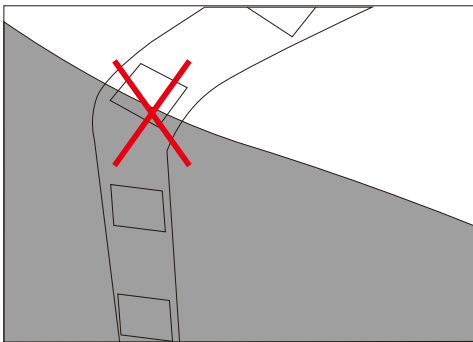
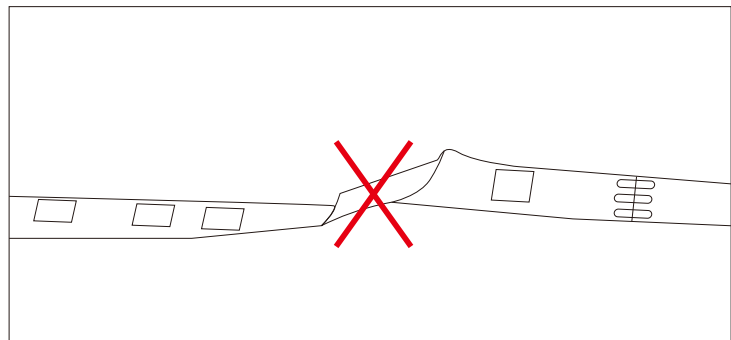
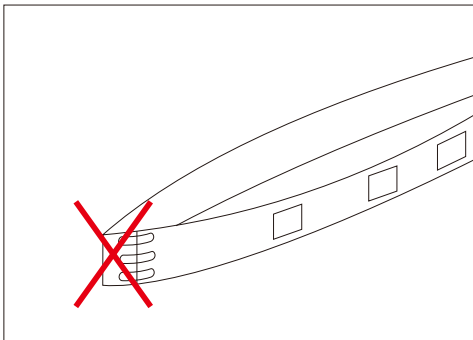

Bend (Right)

