



# BROCHURE

Surmountor Lighting CO., Limited



[www.surmountor.com](http://www.surmountor.com)

+86-755-27926119/27926326    sales@surmountor.com

[www.surmountor.com](http://www.surmountor.com) / [www.sur-led.com](http://www.sur-led.com) / [www.ledstrip.cc](http://www.ledstrip.cc)

4/F, No.2 Factory Building, Dayang, No.4 Tangwei Industrial Avenue,  
Fuyong Street, Bao'an, Shenzhen, China



## 2024-2025

Neon led strip light/ 360° Round silicone neon light

Rectangle silicone neon light

# SILICONE NEON LIGHT

▶ ONE-STOP SERVICE

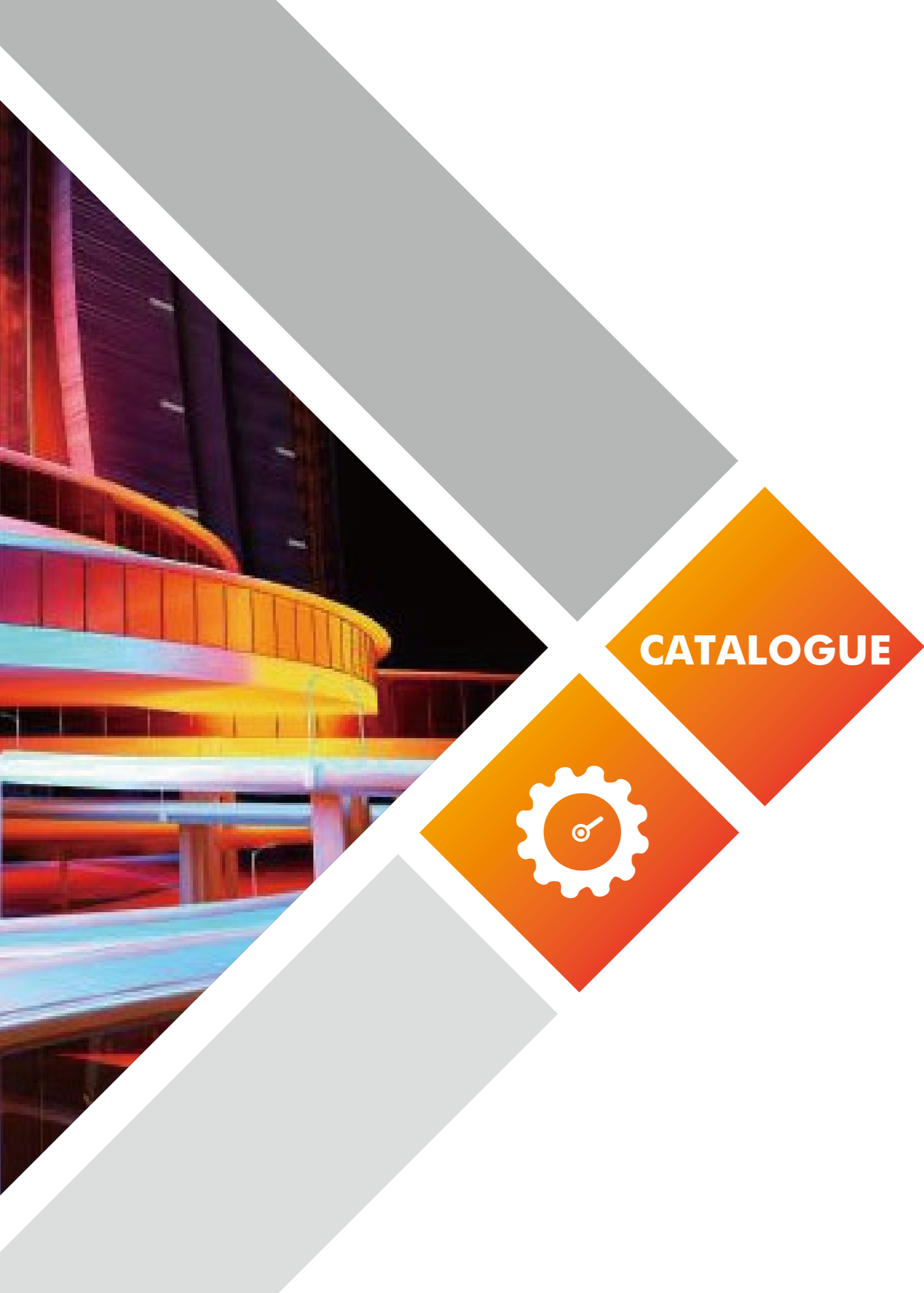

## TABLE OF CONTENTS

### About surmountor

Company overview	01-02
Main markets distribution	03-04

### Neon silicone tube

Neon silicone tube sizes	05-07
Application scenarios	08
Neon LED strip light	09-30
Black neon strip light	31-32
360°Round neon silicone tube	33-44
Rectangle neon silicone tube	45-62
Rectangle neon silicone cover	63-70

# ABOUT OUR COMPANY



## We are professional LED light factory

Our factory is over 40,000m<sup>2</sup>, with 100 experienced workers and 9 of them are professional R&D staff. We have various LED lights: Grow Lights, LED Aluminum Profile, LED Linear Lighting, Flexible LED Strip, LED Neon Flex, and Grow Light RJ control port system. Also we can provide perfect ODM/OEM Led light solution to our customers.

Surmountor Lighting Co.,Ltd was founded in 2009 and we have focused on the LED industry for over 10 years. We have cooperated with over 2000 customers from 50 countries. Our product qualification rate is above 99.99%, which contribute a lot to our good reputation in the US, Europe and other countries. Based on our professional products and service we have establish long term relationship with many customers.



## We have strict quality control

Quality is always priority in Surmountor production line. We have 9 QC staff on each production line. From raw material procurement, production to packaging, every process is strictly inspected. Before delivery, all of our lights will undergo 24hours aging test to ensure that our customers can receive high-quality qualified products. And we have CE, UL, RoHS, ISO9001:2015 certificates.



## Continuous innovation and R&D

Surmountor Lighting Co.,Ltd was founded in 2009, with over 10 years experience in LED light industry and over 5 years experience in Grow Light industry, we can provide perfect solution to all growers.

Main products: Quantum Board Grow Light, Grow Light Bars, Grow Light Controller, and Grow Tent.



## We have a great team

Our energetic and creative sales team could understand customers' demands deeply and solve problems promptly. Every customer should be concerned and respected seriously, patiently, responsibly from enquiry-design-sampling-order-production. Based on all our efforts, we attained great achievements and progress in the past 10 years, we also help our customers to expand their markets by constantly developing new products.



Our target is to satisfy our clients with good quality & best service. Welcome to join us and let us brighten our future together!

Johnson Wan  
Surmountor CEO



## Our pursuit

Our main strong point is our engineers can work out light solutions upon our customer's needs. Our goal is to build long term win-win relationship with our customers.

## MAIN MARKETS DISTRIBUTION

Based on excellent quality and dedicated service, Surmountor is highly recognized and favored by foreign customers, enjoys a high reputation and fame in overseas markets, and has become one of the global consumers' reliable led brands. Products are exported to Europe, North America, Latin America, Australia, Middle East and more than 50 countries.



Cooperation  
Partners

> 90

# NEON SILICONE TUBE SIZES

- Optimal Performance
- More convenient installation
- More extensive application

## NEON LED STRIP LIGHT

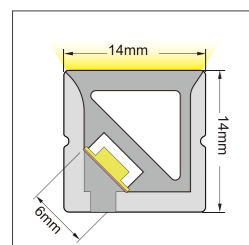

N1414D

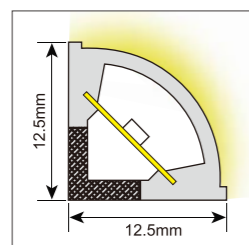

N1212

## SIDE BEND

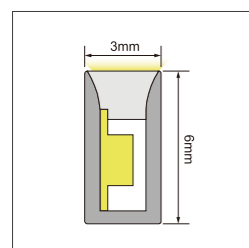

N0306D

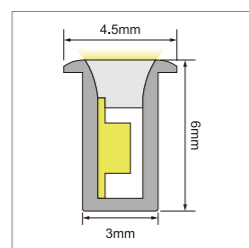

N0306T

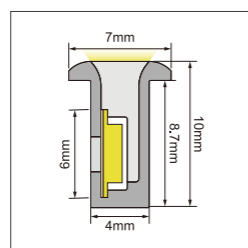

N0410T

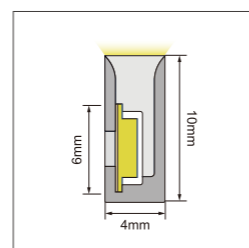

N0410D

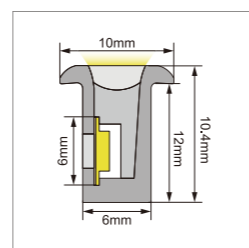

N0612T

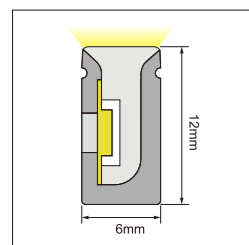

N0612D

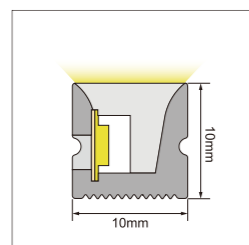

N1010D-SIDE

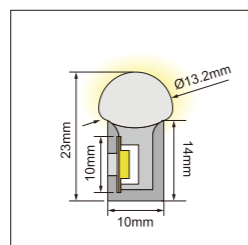

N1023D

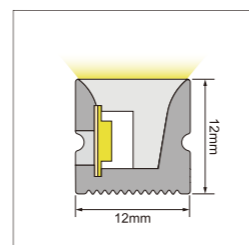

N1212D-SIDE

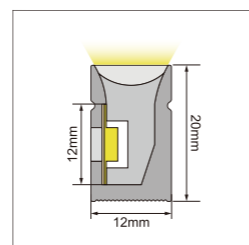

N1220D

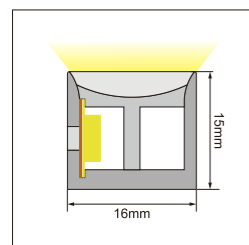

N1615D-SIDE

## TOP BEND

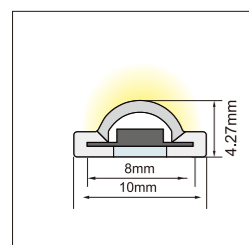

F-NEON-280

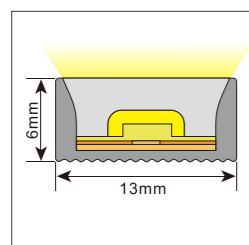

N0613C

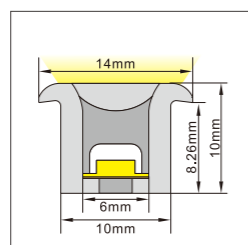

N1010T

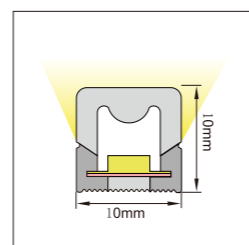

N1010D-TS

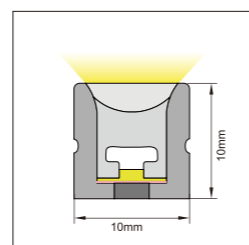

N1010D-TOP

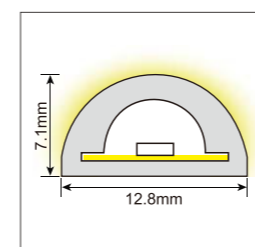

N1207

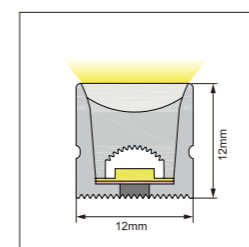

N1212D-TOP

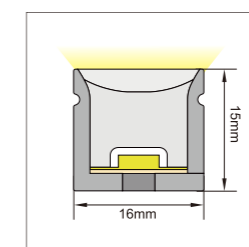

N1615D-TOP

## BLACK NEON STRIP LIGHT

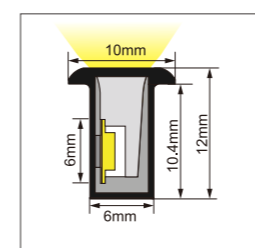

N0612T-B

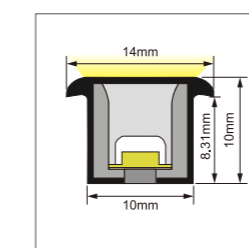

N1010T-B

## 360° ROUND NEON SILICONE TUBE

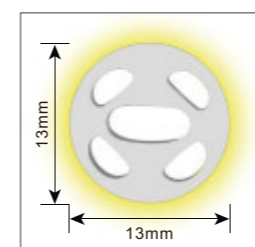

ND13

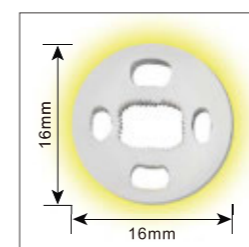

ND16

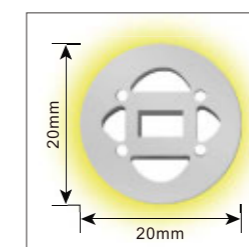

ND20

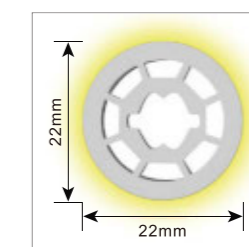

ND22

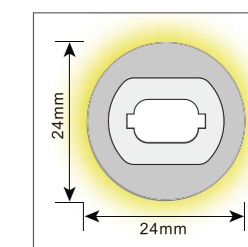

ND24D

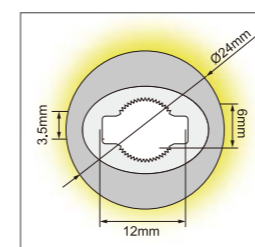

FND24D

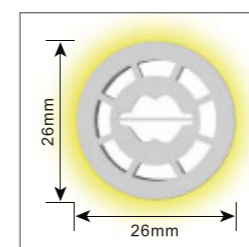

ND26

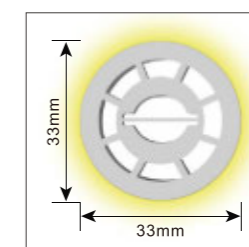

ND33

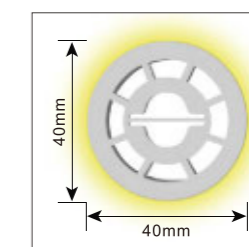

ND40

## RECTANGLE NEON SILICONE TUBE

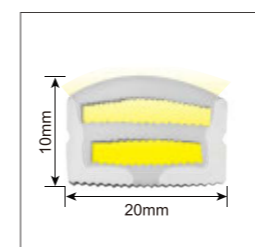

N2010

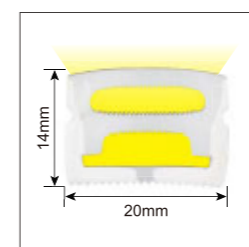

N2014

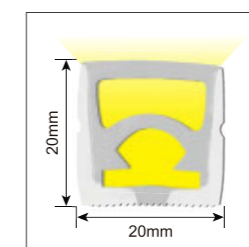

N2020

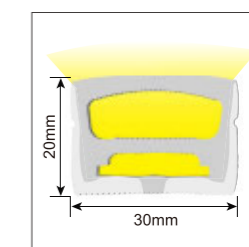

N3020

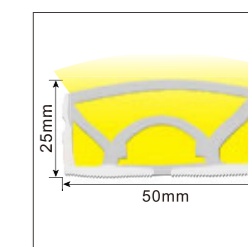

N5025

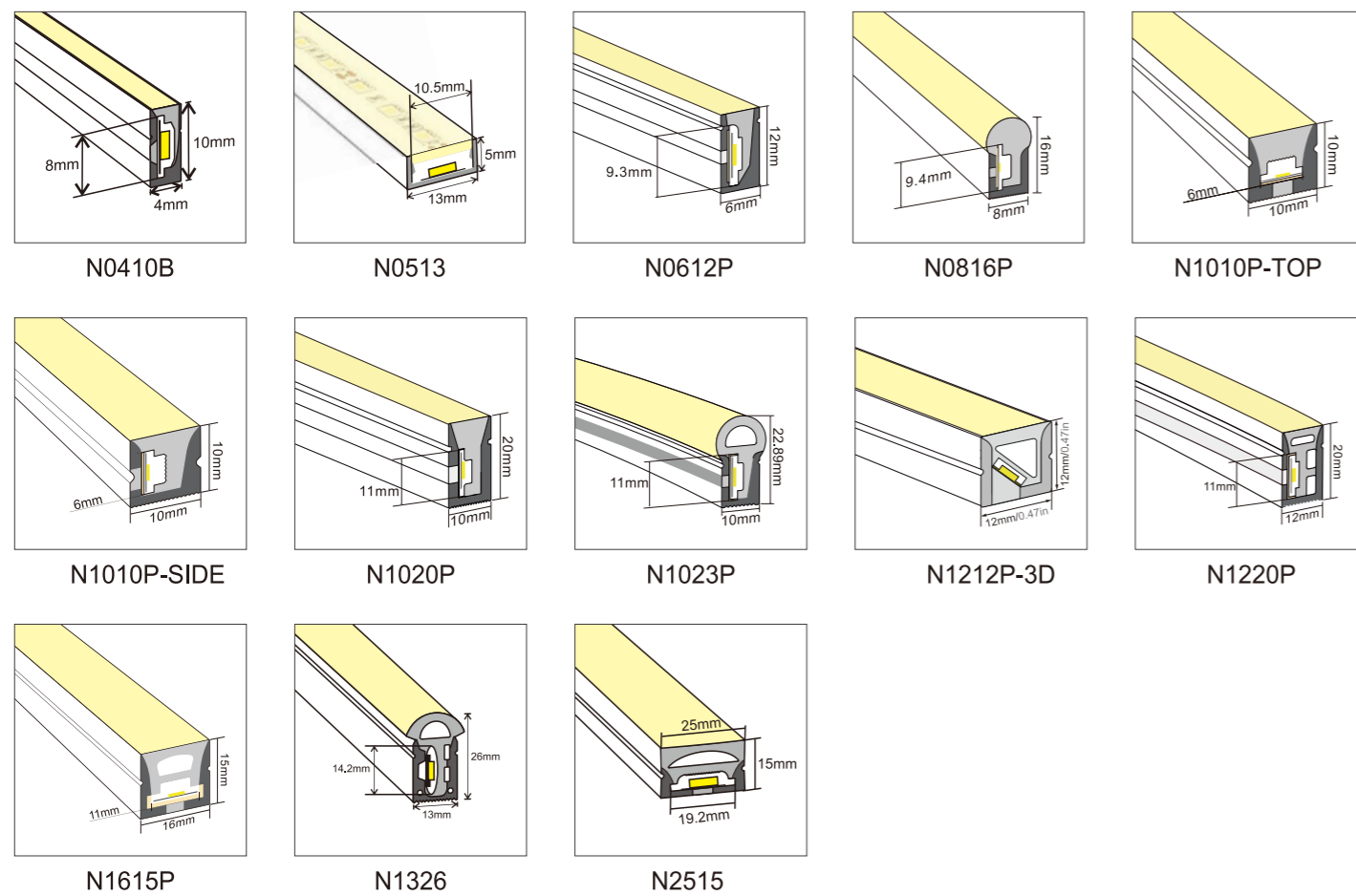

**RECTANGLE NEON SILICONE COVER**

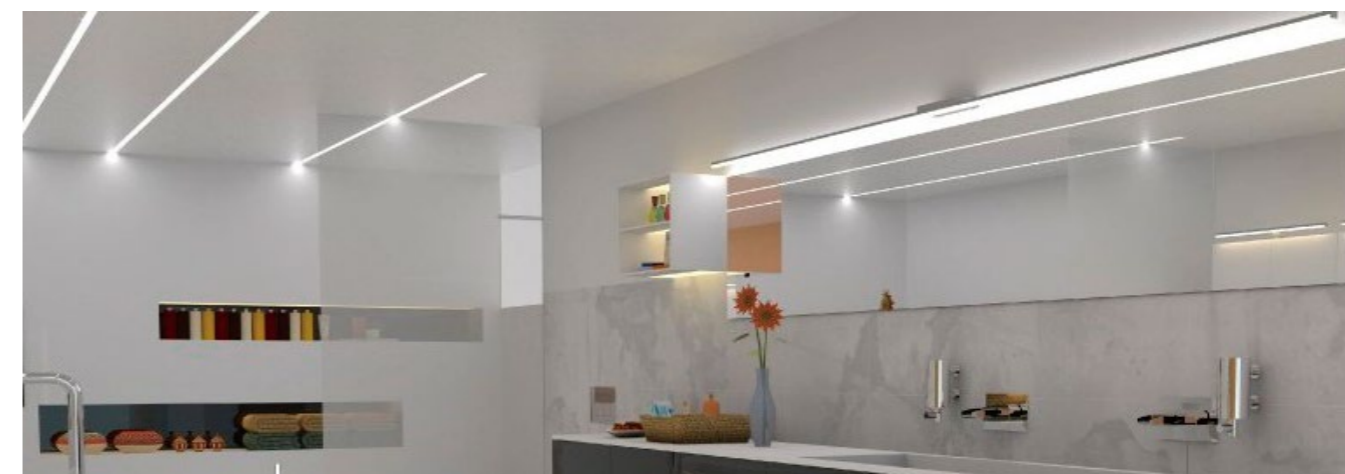
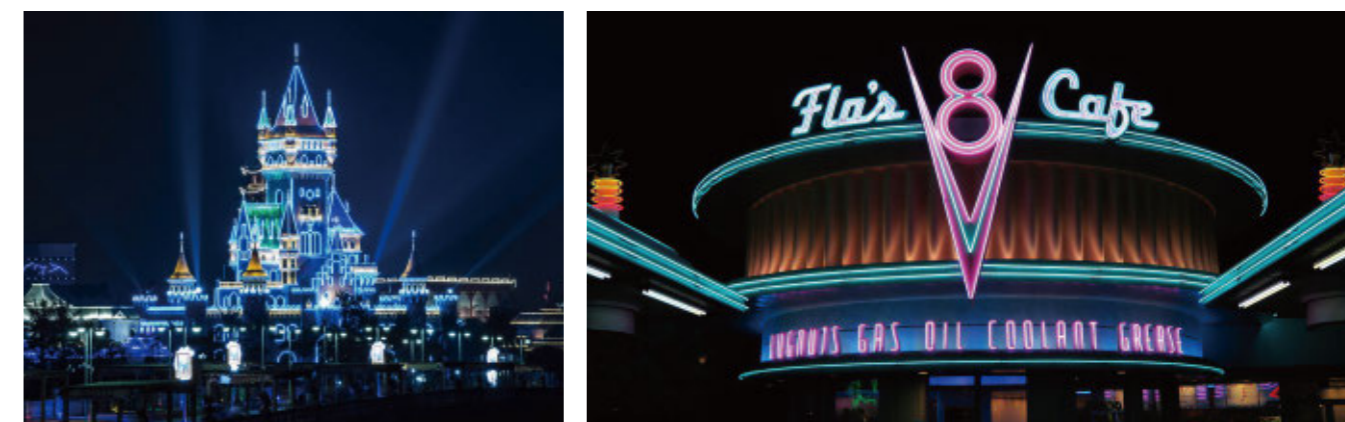
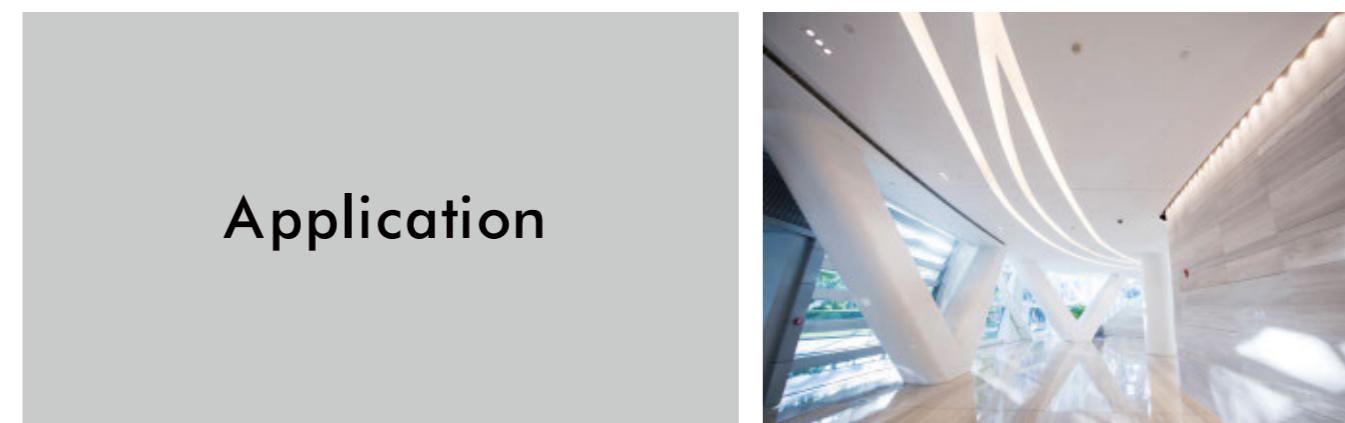
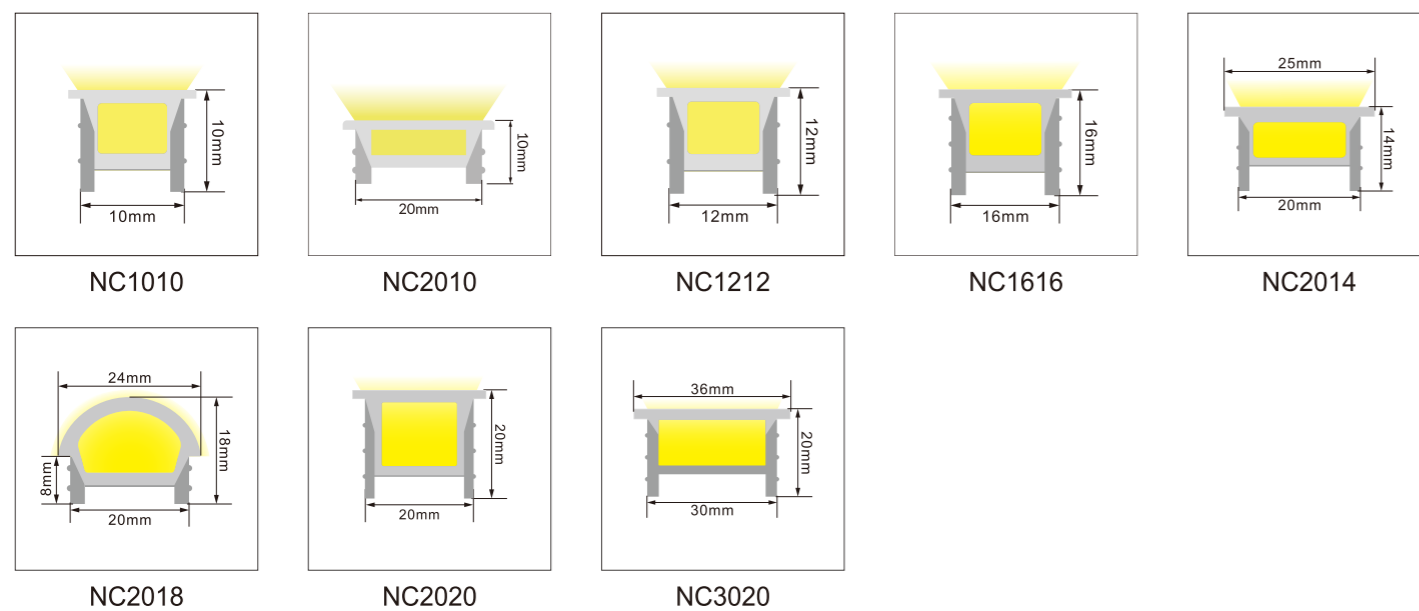



## N1414D



### FEATURES

- Power: 9.6w/m, 24vdc
- LED color: WW/NW/CW/Customized
- Product size: 14\*14mm
- Material: Silicone
- N.W.(G/M): 200g
- IP rate: IP67 waterproof
- Cable output: 1M cable output on both ends
- Length: 5M/reel, Customized
- Dot less and beautiful lighting



## N1212



### FEATURES

- Power: 19.2w/m, 24vdc
- LED color: WW/NW/CW/Customized
- Product size: 12.5\*12.5mm
- Material: Silicone
- IP rate: IP67 waterproof
- Length: 5M/reel, customized
- Cable output: 1M cable output on both ends
- With 3M double side tape on the back
- Dot less and beautiful lighting

### PRODUCT SIZE

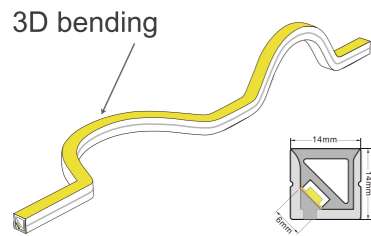

### CUT ANYWHERE OPTION



without cut mark



Built-in LED Strip

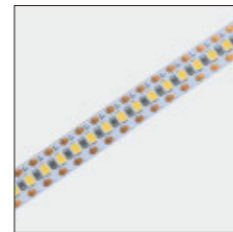

SUR-2835FW180-24V  
Power/M: 9.6W

### PRODUCT SIZE

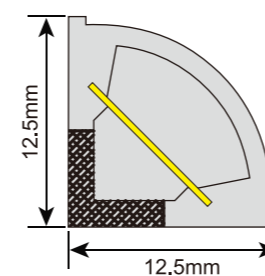

### STANDARD ACCESSORIES



Product body



End Cap x4  
1 with holesx3  
1 without hole



Mounting Clip  
1 Metal



Mounting Clip  
1 Metal: 1m/pc



Bendable mounting clips  
(Optional)

### PRODUCT SIZE

### STANDARD ACCESSORIES



Product body



End Cap x2  
1 with holes  
1 without hole



Mounting Clip  
Metal

### SCENE DISPLAY

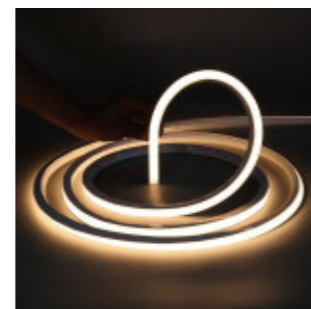
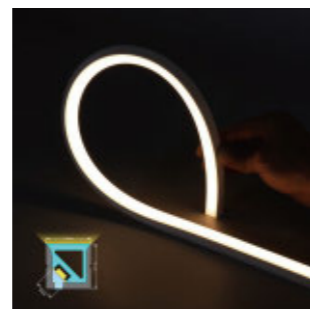

### PRODUCT SIZE

### SCENE DISPLAY

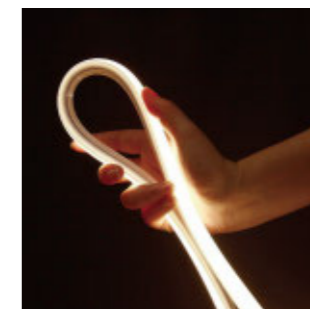



## N0306D



### FEATURES

- Power: 7w/m, 24vdc
- LED color: WW/NW/CW/Customized
- Product size: 3\*6mm
- Material: Silicone
- N.W.(G/M): 28g
- IP rate: IP67 waterproof
- Cable output: 1M cable output on both ends
- Length: 5M/reel, Customized
- Dot less and beautiful lighting



## N0306T



### FEATURES

- Power: 7w/m, 24vdc
- LED color: WW/NW/CW/Customized
- Product size: 3\*6mm
- Material: Silicone
- N.W.(G/M): 28g
- IP rate: IP67 waterproof
- Cable output: 1M cable output on both ends
- Length: 5M/reel, Customized
- Dot less and beautiful lighting

### PRODUCT SIZE

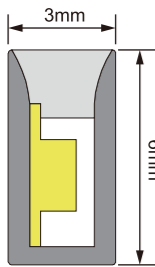

### STANDARD ACCESSORIES



Product body



End Cap x2  
1 with holes  
1 without hole



Mounting Clip  
1 Metal

### SCENE DISPLAY

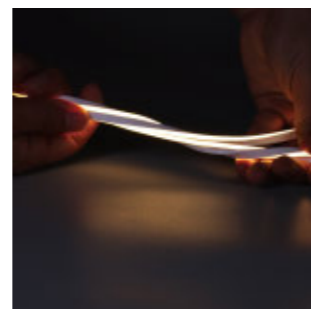
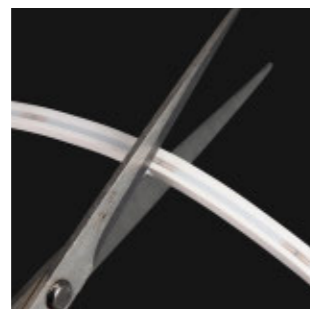
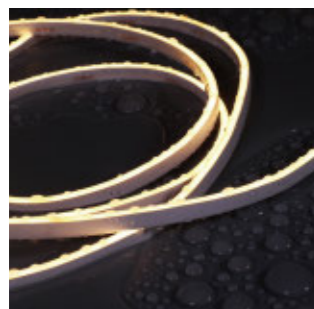

### PRODUCT SIZE

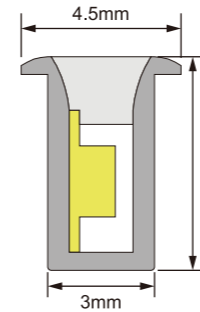

### STANDARD ACCESSORIES



Product body



End Cap x2  
1 with holes  
1 without hole

### SCENE DISPLAY

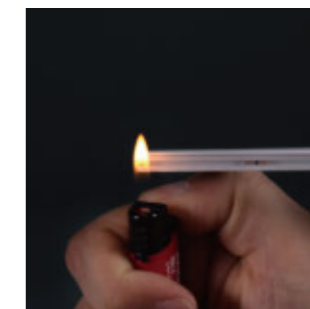





## N0410T



### FEATURES

- Power: 9.6w/m, 24vdc
- LED color: WW/NW/CW/Customized
- Product size: 4\*10mm
- Material: Silicone
- N.W.(G/M): 30g
- IP rate: IP67 waterproof
- Cable output: 1M cable output on both ends
- Length: 5M/reel, Customized
- Dot less and beautiful lighting



## N0410D



### FEATURES

- Power: 9.6w/m, 24vdc
- LED color: WW/NW/CW/Customized
- Product size: 4\*10mm
- Material: Silicone
- N.W.(G/M): 25g
- IP rate: IP67 waterproof
- Cable output: 1M cable output on both ends
- Length: 5M/reel, Customized
- Dot less and beautiful lighting

### PRODUCT SIZE

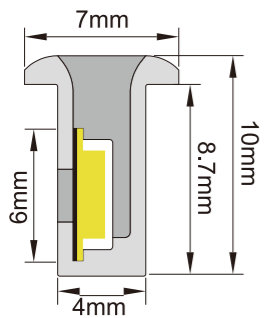

### CUT ANYWHERE OPTION



without cut mark



Built-in LED Strip

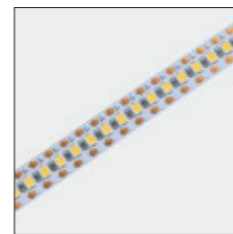

SUR-2835FW180-24V  
Power/M: 9.6W

### STANDARD ACCESSORIES



Product body



End Cap x2

1 with holes

1 without hole

### SCENE DISPLAY

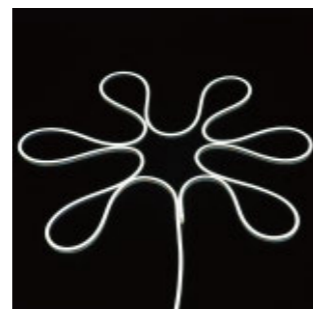

### PRODUCT SIZE

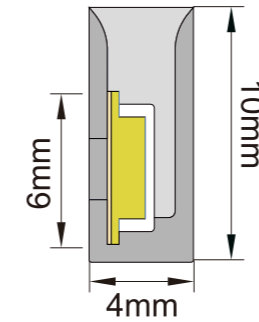

### CUT ANYWHERE OPTION



without cut mark



Built-in LED Strip

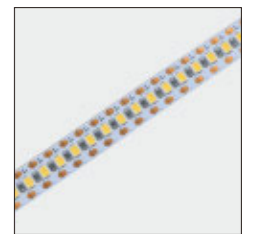

SUR-2835FW180-24V  
Power/M: 9.6W

### STANDARD ACCESSORIES



Product body



End Cap x2

1 with holes

1 without hole



Mounting Clip

1 Metal



Mounting Clip

1 Metal: 1m/pc



Bendable mounting clips

(Optional)

### SCENE DISPLAY

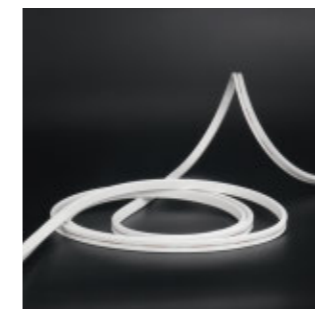



## N0612T



### FEATURES

- Power: 9.6w/m, 24vdc
- LED color: WW/NW/CW/Customized
- Product size: 6\*12mm
- Material: Silicone
- N.W.(G/M): 115g
- IP rate: IP67 waterproof
- Cable output: 1M cable output on both ends
- Length: 5M/reel, Customized
- Dot less and beautiful lighting



## N0612D



### FEATURES

- Power: 9.6w/m, 24vdc
- LED color: WW/NW/CW/Customized
- Product size: 6\*12 mm
- Material: Silicone
- N.W.(G/M): 100g
- IP rate: IP67 waterproof
- Cable output: 1M cable output on both ends
- Length: 5M/reel, Customized
- Dot less and beautiful lighting

### PRODUCT SIZE

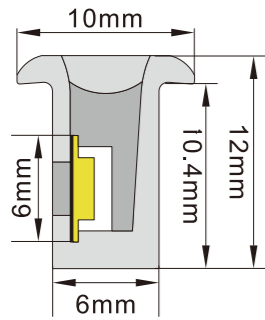

### CUT ANYWHERE OPTION



without cut mark



Built-in LED Strip

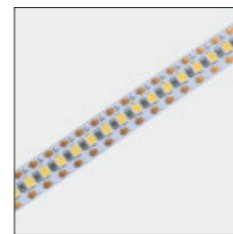

SUR-2835FW180-24V  
Power/M: 9.6W

### STANDARD ACCESSORIES



Product body



End Cap x2

1 with holes

1 without hole

### SCENE DISPLAY

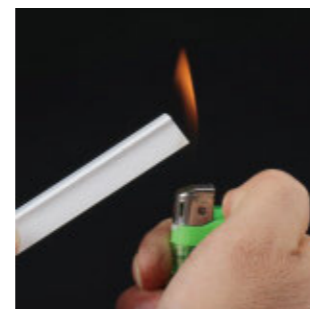
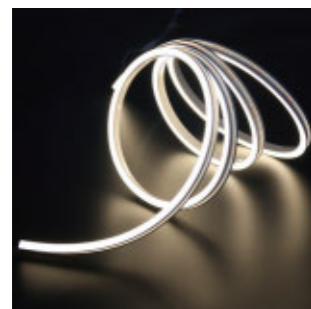

### PRODUCT SIZE

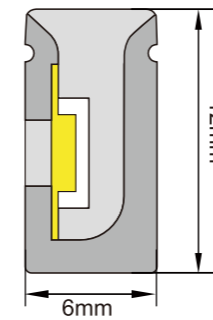

### CUT ANYWHERE OPTION



without cut mark



Built-in LED Strip

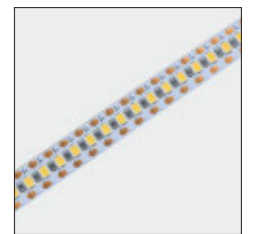

SUR-2835FW180-24V  
Power/M: 9.6W

### STANDARD ACCESSORIES



Product body



End Cap x4

1 with holes\*3

1 without hole



Mounting Clip

1 Metal



Mounting Clip

1 Metal: 1m/pc



Bendable mounting clips

(Optional)

### SCENE DISPLAY

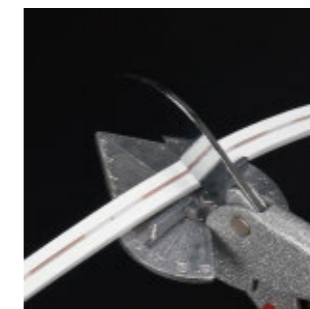



**N1010D-SIDE**     

**FEATURES**

- Power: 9.6w/m, 24vdc
- LED color: WW/NW/CW/Customized
- Product size: 10\*10mm
- Material: Silicone
- N.W.(G/M): 130g
- IP rate: IP67 waterproof
- Cable output: 1M cable output on both ends
- Length: 5M/reel, Customized
- Dot less and beautiful lighting



**N1023D**     

**FEATURES**

- Power: 14.4w/m, 24vdc
- LED color: WW/NW/CW/Customized
- Product size: 10\*23mm
- Material: Silicone
- N.W.(G/M): 305g
- IP rate: IP67 waterproof
- Cable output: 1M cable output on both ends
- Length: 5M/reel, Customized
- Dot less and beautiful lighting

**PRODUCT SIZE**

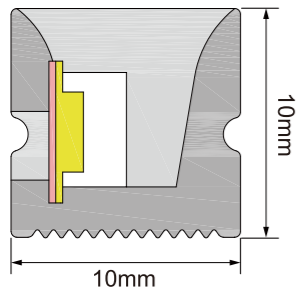

**CUT ANYWHERE OPTION**



without cut mark



Built-in LED Strip

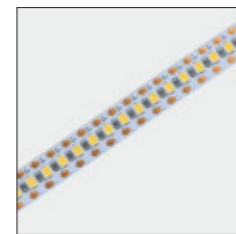

SUR-2835FW180-24V  
Power/M: 9.6W

**STANDARD ACCESSORIES**



Product body



End Cap x4  
1 with holesx3  
1 without hole



Mounting Clip  
1 Metal

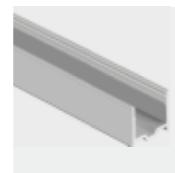

Mounting Clip  
1 Metal: 1m/pc



Bendable mounting clips  
(Optional)

**SCENE DISPLAY**



**PRODUCT SIZE**

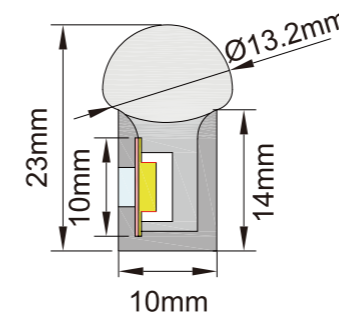

**CUT ANYWHERE OPTION**



without cut mark



Built-in LED Strip

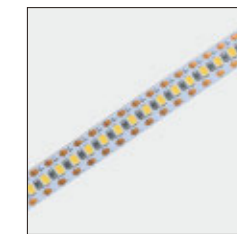

SUR-2835FW180-24V  
Power/M: 9.6W

**STANDARD ACCESSORIES**



Product body



End Cap x4  
1 with holesx3  
1 without hole



Mounting Clip  
1 Metal



Mounting Clip  
1 Metal: 1m/pc



Bendable mounting clips  
(Optional)

**SCENE DISPLAY**

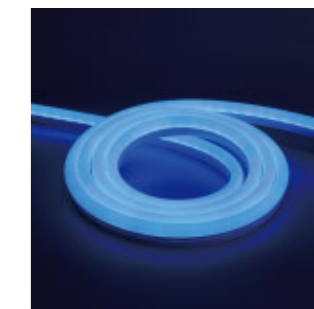
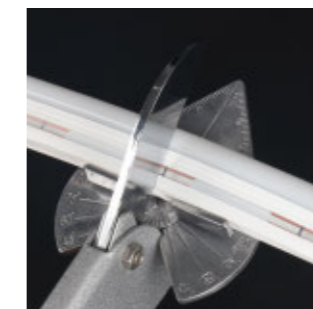



## N1212D-SIDE



### FEATURES

- Power: 14.4w/m, 24vdc
- LED color: WW/NW/CW/Customized
- Product size: 12\*20mm
- Material: Silicone
- N.W.(G/M): 310g
- IP rate: IP67 waterproof
- Cable output: 1M cable output on both ends
- Length: 5M/reel, Customized
- Dot less and beautiful lighting



## N1220D



### FEATURES

- Power: 14.4w/m, 24vdc
- LED color: WW/NW/CW/Customized
- Product size: 12\*20mm
- Material: Silicone
- N.W.(G/M): 310g
- IP rate: IP67 waterproof
- Cable output: 1M cable output on both ends
- Length: 5M/reel, Customized

### PRODUCT SIZE

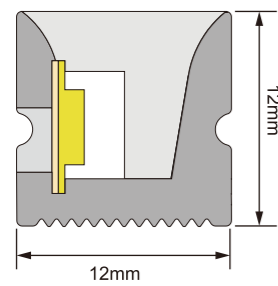

### CUT ANYWHERE OPTION



without cut mark



Built-in LED Strip

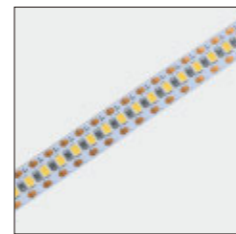

SUR-2835FW180-24V  
Power/M: 9.6W

### PRODUCT SIZE

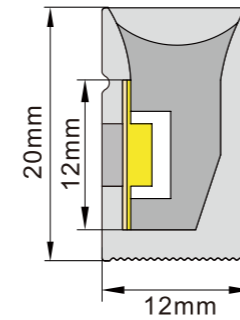

### CUT ANYWHERE OPTION



without cut mark



Built-in LED Strip

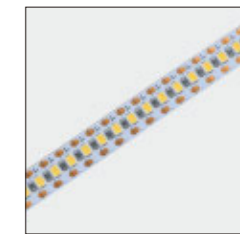

SUR-2835FW180-24V  
Power/M: 9.6W

### STANDARD ACCESSORIES



Product body



End Cap x4  
1 with holesx3  
1 without hole



Mounting Clip  
1 Metal



Mounting Clip  
1 Metal: 1m/pc



Bendable mounting clips  
(Optional)

### STANDARD ACCESSORIES



Product body



Direct outlet plug  
Endcap without cable



End Cap x4  
1 with holesx3  
1 without hole

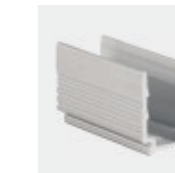

Mounting Clip  
1 Metal



Mounting Clip  
1 Metal: 1m/pc



Bendable mounting clips  
(Optional)

### SCENE DISPLAY

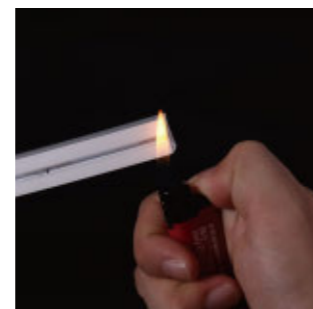
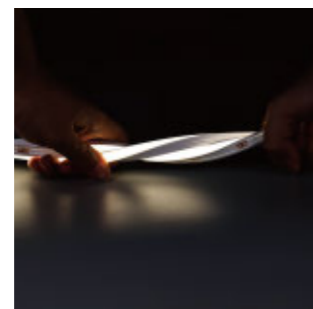

### SCENE DISPLAY

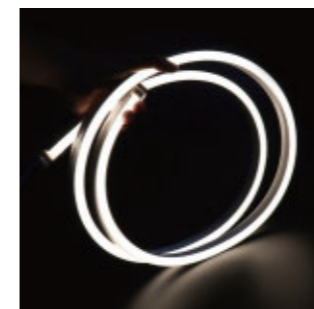



## N1615D-SIDE



### FEATURES

- Power: 14.4w/m, 24vdc
- LED color: WW/NW/CW/Customized
- Product size: 16\*15mm
- Material: Silicone
- N.W.(G/M): 200g
- IP rate: IP67 waterproof
- Cable output: 1M cable output on both ends
- Length: 5M/reel, Customized
- Dot less and beautiful lighting



### PRODUCT SIZE

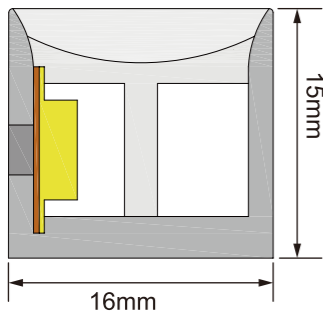

### CUT ANYWHERE OPTION



without cut mark



Built-in LED Strip

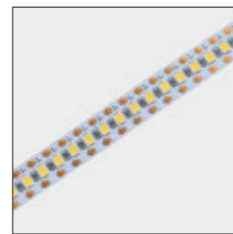

SUR-2835FW180-24V  
Power/M: 9.6W

### STANDARD ACCESSORIES



Product body



End Cap x4  
1 with holesx3  
1 without hole

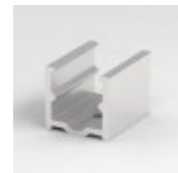

Mounting Clip  
1 Metal

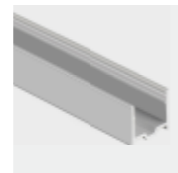

Mounting Clip  
1 Metal: 1m/pc



Bendable mounting clips  
(Optional)

### SCENE DISPLAY

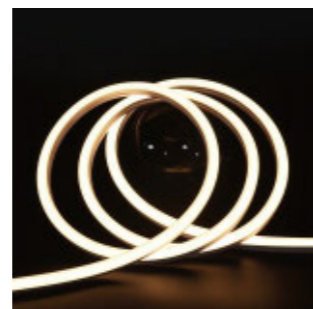



## F-NEON-280



### FEATURES

- Power: 10w/m, 24vdc
- LED color: WW/NW/CW/Customized
- Product size: 10\*4mm
- CRI: >90
- Unit Length: 25mm
- IP rate: IP67 waterproof
- Length: 5M/reel, Customized
- Dot less and beautiful lighting

### PRODUCT SIZE

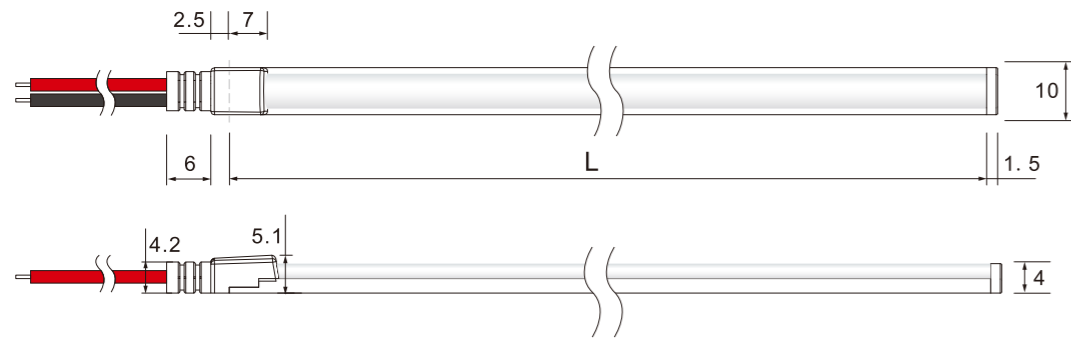

### STANDARD ACCESSORIES



Product body

End Cap x2  
1 with holes  
1 without hole

### SCENE DISPLAY

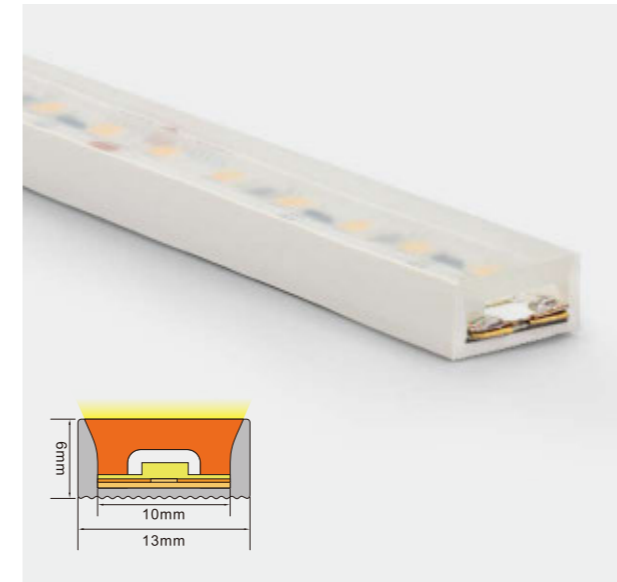

## N0613C



### FEATURES

- Power: 9.6w/m, 24vdc
- LED color: WW/NW/CW/Customized
- Product size: 6\*13mm
- PCB width: 10mm
- IP Grade: IP67
- N.W.(G/M): 117g
- Material: Silicone
- Length/reel: 25m/reel 50m/reel
- Working temperature: -20 to 50°C
- Color: White and customized color
- Same brightness& no voltage drop within 25meter for single-ended power connection

### PRODUCT SIZE

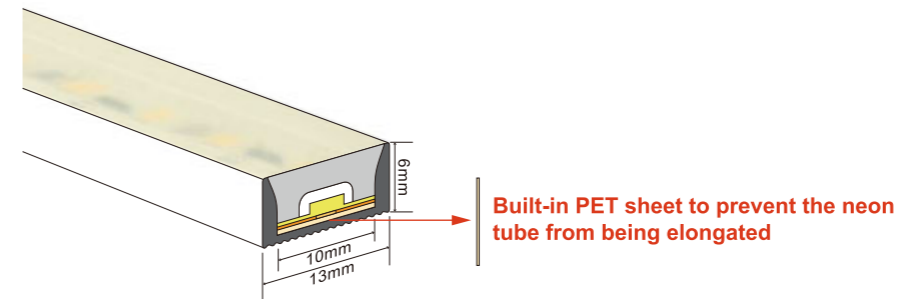

### STANDARD ACCESSORIES



Product body

End cap with power input connector

End cap without hole

Fixed clips  
Plastic

Fixed clips  
Metal

### SCENE DISPLAY





## N1010T



### FEATURES

- Power: 9.6w/m, 24vdc
- LED color: WW/NW/CW/Customized
- Product size: 10\*10mm
- Material: Silicone
- N.W.(G/M): 95g
- IP rate: IP67 waterproof
- Cable output: 1M cable output on both ends
- Length: 5M/reel, Customized
- Dot less and beautiful lighting



## N1010D-TS



### FEATURES

- Power: 9.6w/m, 24vdc
- LED color: WW/NW/CW/Customized
- Product size: 10\*10mm
- Material: Silicone
- N.W.(G/M): 140g
- IP rate: IP67 waterproof
- Cable output: 1M cable output on both ends
- Length: 5M/reel, Customized
- Dot less and beautiful lighting

### PRODUCT SIZE

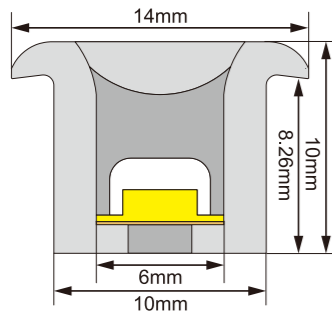

### STANDARD ACCESSORIES



Product body



End Cap x2

1 with holes

1 without hole

### SCENE DISPLAY

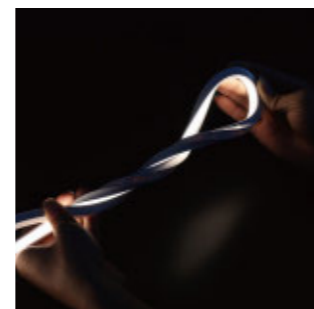
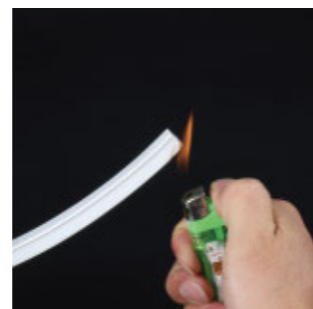

### PRODUCT SIZE

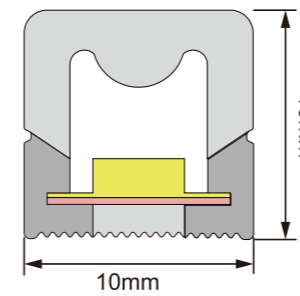

### STANDARD ACCESSORIES



Product body



End Cap x2

1 with holes

1 without hole

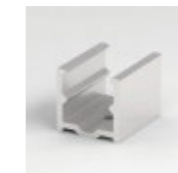

Mounting Clip

1 Metal

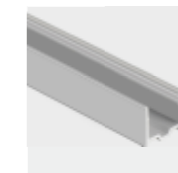

Mounting Clip

1 Metal: 1m/pc

### SCENE DISPLAY

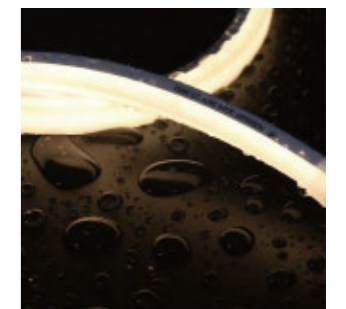
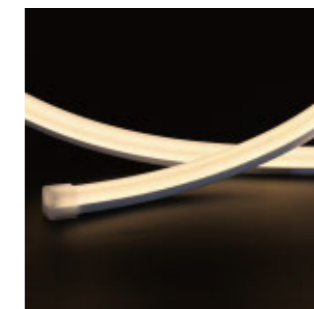
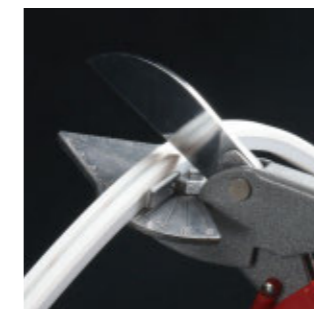



## N1010D-TOP



### FEATURES

- Power: 9.6w/m, 24vdc
- LED color: WW/NW/CW/Customized
- Product size: 10\*10mm
- Material: Silicone
- N.W.(G/M): 135g
- IP rate: IP67 waterproof
- Cable output: 1M cable output on both ends
- Length: 5M/reel, Customized
- Dot less and beautiful lighting



## N1207



### FEATURES

- Power: 19.2w/m, 24vdc
- LED color: WW/NW/CW/Customized
- Product size: 12.8\*7.1mm
- Material: Silicone
- IP rate: IP67 waterproof
- Length: 5M/reel, Customized
- Cable output: 1M cable output on both ends
- With 3M double side tape on the back
- Dot less and beautiful lighting

### PRODUCT SIZE

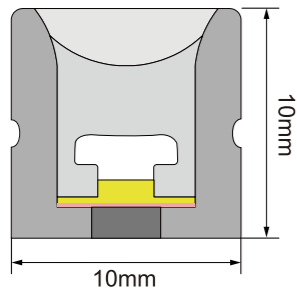

### CUT ANYWHERE OPTION



without cut mark



Built-in LED Strip

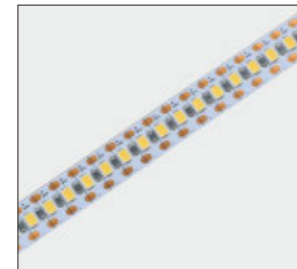

SUR-2835FW180-24V  
Power/M: 9.6W

### STANDARD ACCESSORIES



Product body



End Cap x4  
1 with holesx3  
1 without hole



Mounting Clip  
1 Metal

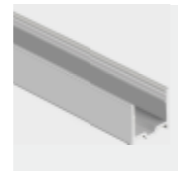

Mounting Clip  
1 Metal: 1m/pc



Bendable mounting clips  
(Optional)

### SCENE DISPLAY

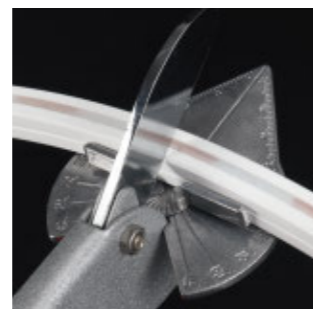
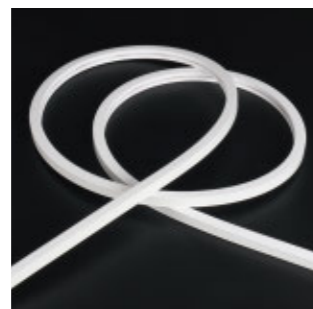

### PRODUCT SIZE

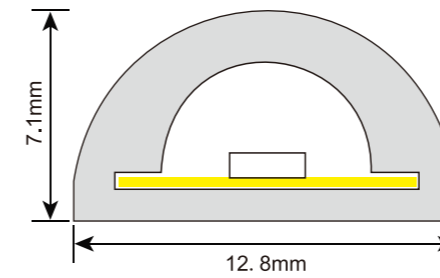

### STANDARD ACCESSORIES



Product body



Mounting Clip  
Plastic

### SCENE DISPLAY

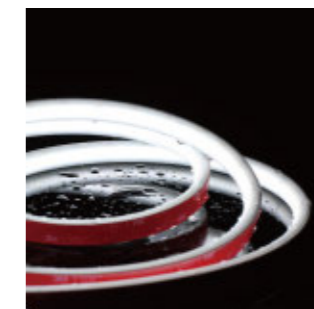
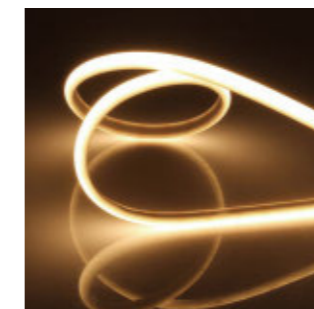





## N1212D-TOP



### FEATURES

- Power: 9.6w/m, 24vdc
- LED color: WW/NW/CW/Customized
- Product size: 12\*12mm
- Material: Silicone
- N.W.(G/M): 200g
- IP rate: IP67 waterproof
- Cable output: 1M cable output on both ends
- Length: 5M/reel, Customized
- Dot less and beautiful lighting



## N1615D-TOP



### FEATURES

- Power: 14.4w/m, 24vdc
- LED color: WW/NW/CW/Customized
- Product size: 16\*15mm
- Material: Silicone
- N.W.(G/M): 330g
- IP rate: IP67 waterproof
- Cable output: 1M cable output on both ends
- Length: 5M/reel, Customized
- Dot less and beautiful lighting

### PRODUCT SIZE

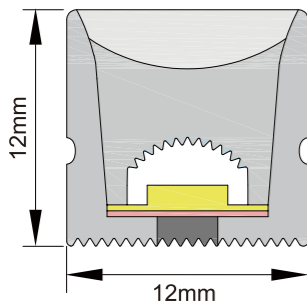

### CUT ANYWHERE OPTION



without cut mark



Built-in LED Strip

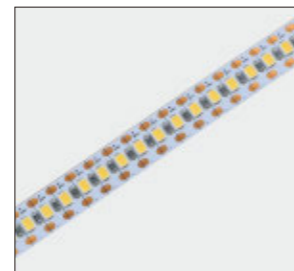

SUR-2835FW180-24V  
Power/M: 9.6W

### STANDARD ACCESSORIES



Product body



End Cap x3  
1 with holesx2  
1 without hole



Mounting Clip  
1 Metal

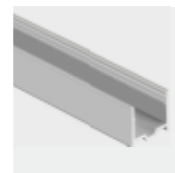

Mounting Clip  
1 Metal: 1m/pc



Bendable mounting clips  
(Optional)

### SCENE DISPLAY

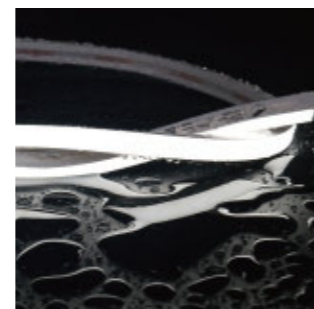
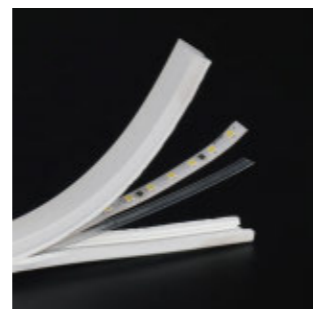

### PRODUCT SIZE

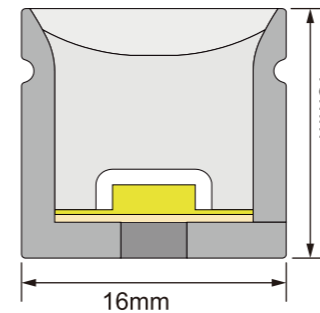

### CUT ANYWHERE OPTION



without cut mark



Built-in LED Strip

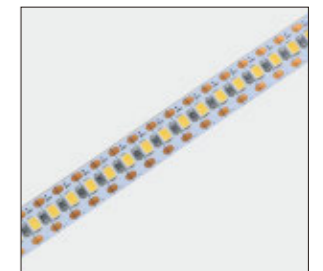

SUR-2835FW180-24V  
Power/M: 9.6W

### STANDARD ACCESSORIES



Product body



Direct outlet plug  
Endcap without cable



End Cap x4  
1 with holesx3  
1 without hole

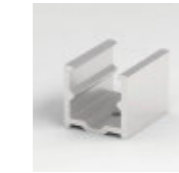

Mounting Clip  
1 Metal

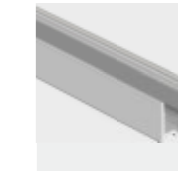

Mounting Clip  
1 Metal: 1m/pc



Bendable mounting clips  
(Optional)

### SCENE DISPLAY

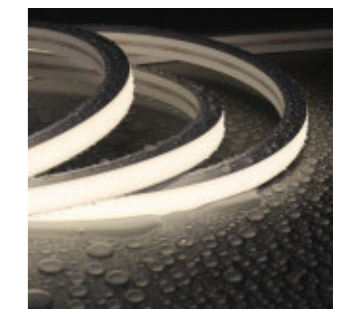
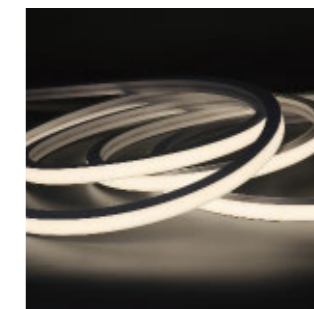
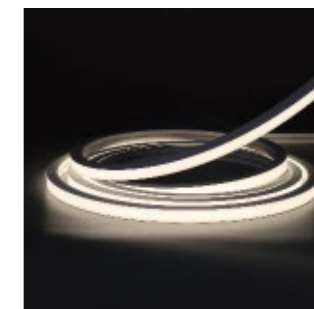



## N0612T-B



### FEATURES

- Power: 9.6w/m, 24vdc
- LED color: WW/NW/CW/Customized
- Product size: 6\*12mm
- Material: Silicone
- N.W.(G/M): 115g
- IP rate: IP67 waterproof
- Cable output: 1M cable output on both ends
- Length: 5M/reel, Customized
- Dot less and beautiful lighting



## N1010T-B



### FEATURES

- Power: 9.6w/m, 24vdc
- LED color: WW/NW/CW/Customized
- Product size: 10\*10mm
- Material: Silicone
- N.W.(G/M): 95g
- IP rate: IP67 waterproof
- Cable output: 1M cable output on both ends
- Length: 5M/reel, Customized
- Dot less and beautiful lighting

### PRODUCT SIZE

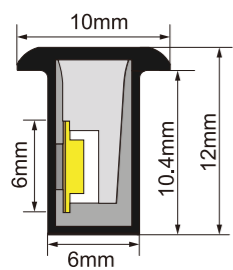

### CUT ANYWHERE OPTION



without cut mark



Built-in LED Strip

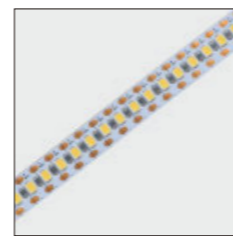

SUR-2835FW180-24V  
Power/M: 9.6W

### STANDARD ACCESSORIES



Product body



End Cap x2

1 with holes

1 without hole

### SCENE DISPLAY

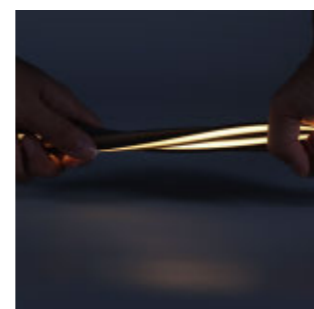

### PRODUCT SIZE

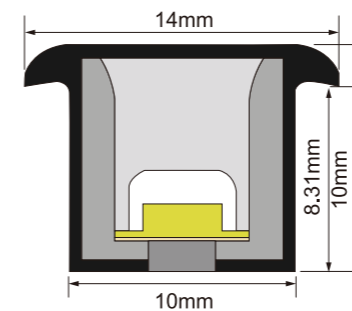

### CUT ANYWHERE OPTION



without cut mark

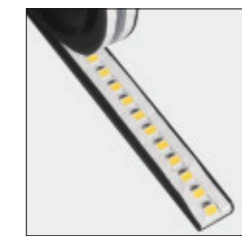

Built-in LED Strip

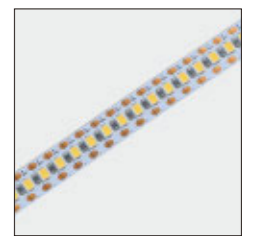

SUR-2835FW180-24V  
Power/M: 9.6W

### STANDARD ACCESSORIES



Product body



End Cap x2

1 with holes

1 without hole

### SCENE DISPLAY

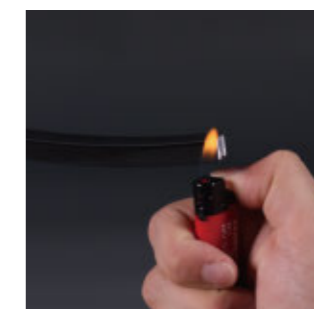
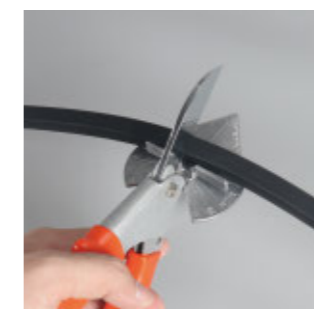
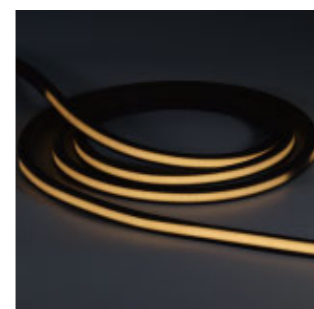



## ND13



### FEATURES

Product size:  $\Phi$ 13mm  
 Material: Silicone  
 Length/reel: 100m/reel  
 PCB width: 5-6mm  
 Weight/Reel: 3.5KG  
 Outer package size: 42\*42\*20cm  
 Color: White and customized color



## ND16



### FEATURES

Product size:  $\Phi$ 16mm  
 Material: Silicone  
 Length/reel: 100m/reel  
 PCB width: 5-6mm  
 Weight/Reel: 17.4KG  
 Outer package size: 50\*50\*20cm  
 Color: White and customized color

### PRODUCT SIZE

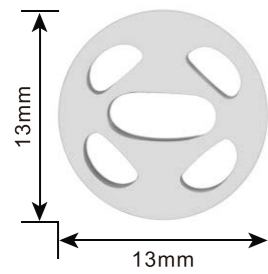

### PRODUCT SIZE

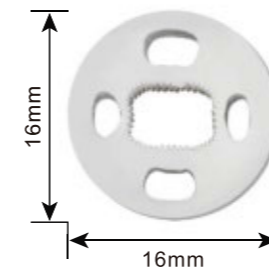

### STANDARD ACCESSORIES

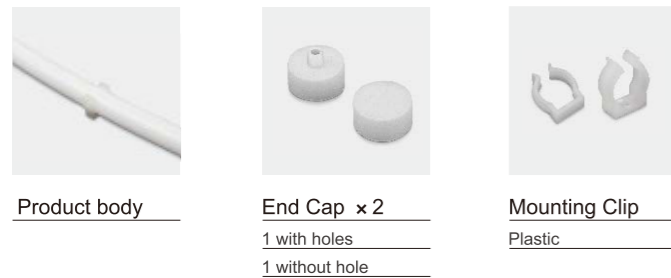

### STANDARD ACCESSORIES



### SCENE DISPLAY

PS: Below is silicone tube with 2 lines led strips pcb back to back inside



### SCENE DISPLAY

PS: Below is silicone tube with 2 lines led strips pcb back to back inside





## ND20



### FEATURES

Product size:  $\Phi$ 20mm  
 Material: Silicone  
 Length/reel: 100m/reel  
 PCB width: 6-8mm  
 Weight/Reel: 32KG  
 Outer package size: 45\*45\*40cm  
 Color: White and customized color



## ND22



### FEATURES

Product size:  $\Phi$ 22mm  
 Material: Silicone  
 Length/reel: 100m/reel  
 PCB width: 8mm  
 Weight/Reel: 32KG  
 Outer package size: 46\*46\*40cm  
 Color: White and customized color

### PRODUCT SIZE

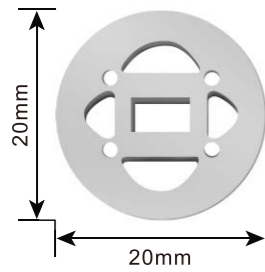

### PRODUCT SIZE

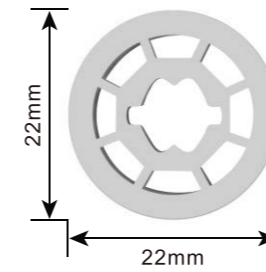

### STANDARD ACCESSORIES



Product body



End Cap × 2

1 with holes  
 1 without hole



Mounting Clip

Plastic

### STANDARD ACCESSORIES



Product body



End Cap × 2

1 with holes  
 1 without hole



Mounting Clip

Plastic

### SCENE DISPLAY

PS: Below is silicone tube with 2 lines led strips pcb back to back inside

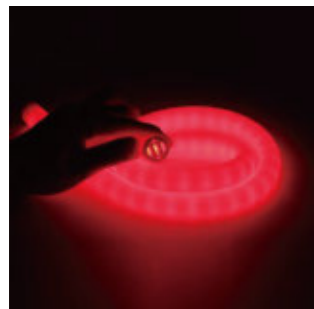

### SCENE DISPLAY

PS: Below is silicone tube with 2 lines led strips pcb back to back inside

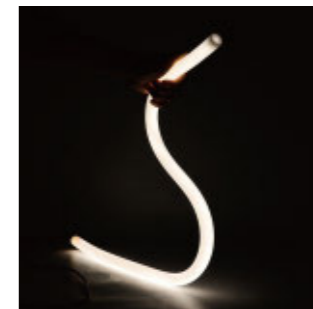
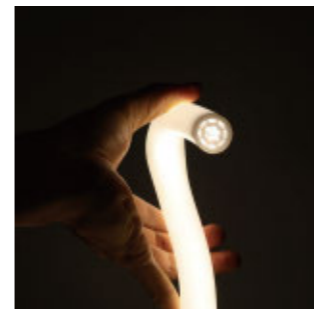

## ND24D



### FEATURES

- Product size:  $\Phi$ 24mm
- Material: Silicone
- Length/reel: 30m/reel
- PCB width: 10mm
- Weight/m: 580G
- Light transmittance: 75%
- Outer package size: 460\*460\*330cm
- Extrusion process: Dual color extrusion

### PRODUCT SIZE

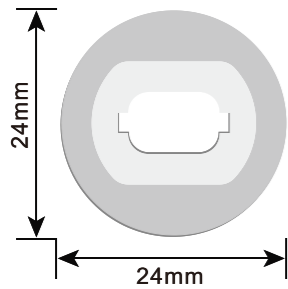

### CUT ANYWHERE OPTION



without cut mark



Built-in LED Strip

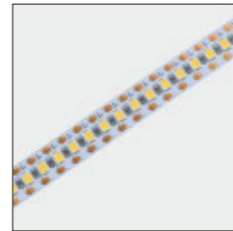

SUR-2835FW180-24V  
Power/M: 9.6W

### CONTROLLER WIRING DIAGRAM

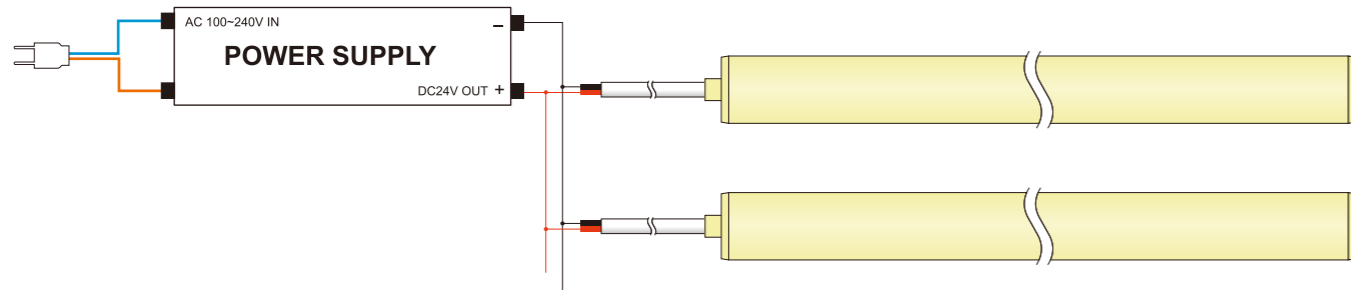

### SCENE DISPLA

PS : Below is silicone tube with 2 lines led strips pcb back to back inside



## ACCESSORIES

Model No.	Application	Accessories picture	Packing List	Accessories list
AS-ND24D-A (Vertical ceiling)			<b>Quantities</b> 20set <b>N.W</b> 0.35KG <b>Total weight</b> 8.2KG <b>Package size</b> L1070*W180*H145	1 meter round PC tube 1 pc Vertical Ceiling installation aluminum end cap 2 pcs fixed aluminum end caps 1 pc aluminum end cap without hole 2 pcs silicone end caps (1pc with hole, 1pc without hole) 8 pcs screws 2 pcs white plastic anchors 1 pc Phillips screwdriver 1 pc M4 hexagonal wrench
AS-ND24D-B (Vertical hoisting)			<b>Quantities</b> 20set <b>N.W</b> 0.45KG <b>Total weight</b> 10.2KG <b>Package size</b> L1070*W180*H145	1 meter round Plastic tube 1 pc Vertical Hoisting installation aluminum end cap 1 pc 1 meter Conductive Steel Rope with cable inside 1 pc aluminum end cap without hole 2 pcs silicone end caps (1pc with hole, 1pc without hole) 7 pcs screws 1 pc white plastic anchors 1 pc Phillips screwdriver
AS-ND24D-C (Double-head ceiling)			<b>Quantities</b> 73set <b>N.W</b> 0.11KG <b>Total weight</b> 9.2KG <b>Package size</b> L468*W375*H237	2 pcs Vertical Ceiling installation aluminum end caps 2 pcs fixed aluminum end caps 2 pcs silicone end caps (1pc with hole, 1pc without hole) 10 pcs screws 4 pcs white plastic anchors 1 pc Phillips screwdriver 1 pc M4 hexagonal wrench
AS-ND24D-D (Horizontal hoisting)			<b>Quantities</b> 20set <b>N.W</b> 0.34KG <b>Total weight</b> 8KG <b>Package size</b> L1070*W180*H145	1 meter round Plastic tube assembled with hanging clips 2 pcs steel rope with copper bolts 2 pcs screws for steel rope bolts 2 pcs silicone end caps (1pc with hole, 1pc without hole) 2 pcs white plastic anchors
AS-ND24D-E (Round hoisting)			<b>Quantities</b> 73set <b>N.W</b> 0.1KG <b>Total weight</b> 8.5KG <b>Package size</b> L468*W375*H237	2 pcs thread locker 2 pcs side outlet aluminum end caps 2 pcs silicone end caps without hole 7 pcs screws 1 pcs plastic anchors 1 pc Phillips screwdriver
AS-ND24D-F (Telescopic rod ceiling)			<b>Quantities</b> 24set <b>N.W</b> 0.17KG <b>Total weight</b> 5.2KG <b>Package size</b> L400*W180*H145	1 set of assembled telescopic rods (the telescopic distance can be adjusted between 300MM-600MM) 1 pc white plastic anchors 1 pc screw
AS-ND24D-G (Steel Rope Ceiling)			<b>Quantities</b> 146set <b>N.W</b> 0.05KG <b>Total weight</b> 8.5KG <b>Package size</b> L468*W375*H237	1 pc 1.5m assembled steel rope (including 30MM round PC tube + 30MM PC clips + 2pcs copper bolts) 1 pc screw 1 pc white plastic anchors
AS-ND24D-H (Wall Mounting)			<b>Quantities</b> 73set <b>N.W</b> 0.09KG <b>Total weight</b> 7.7KG <b>Package size</b> L468*W375*H237	1 pc Vertical Ceiling installation aluminum end cap 1 pcs fixed aluminum end cap 2 pcs silicone end caps (1pc with hole, 1pc without hole) 3 pcs 30MM PC clips 11 pcs screws 2 pcs white plastic anchors 1 pc Phillips screwdriver 1 pc M4 hexagonal wrench



## FND24D



### FEATURES

- Product size:  $\Phi 24\text{mm}$
- Material: Silicone
- Light transmittance: 75%
- Extrusion process: Dual color extrusion
- PCB limited (mm): 10mm
- IP Rating: IP67
- Working temperature:  $-25\sim 80^{\circ}\text{C}$
- Beam angle:  $360^{\circ}$
- PCB limited (mm):  $\phi 100\text{mm}$
- Weight/m: 580g
- Application: Office / Home / Hotel / Exhibition / Hall

### PRODUCT SIZE

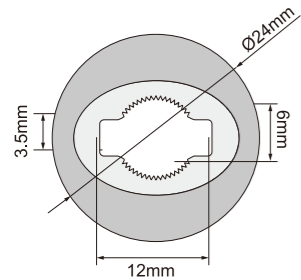

### STANDARD ACCESSORIES



### SCENE DISPLAY

PS: Below is silicone tube with 2 lines led strips pcb back to back inside



### ACCESSORIES

Model No.	Name	Application	Accessories picture	Accessories list
AS-FND24D-A	Vertical ceiling			<ul style="list-style-type: none"> <li>1 meter round PC tube</li> <li>1 pc Vertical Ceiling installation aluminum end cap</li> <li>2 pcs fixed aluminum end caps</li> <li>1 pc aluminum end cap without hole</li> <li>2 pcs silicone end caps (1pc with hole, 1pc without hole)</li> <li>8 pcs screws</li> <li>2 pcs white plastic anchors</li> <li>1 pc Phillips screwdriver</li> <li>1 pc M4 hexagonal wrench</li> </ul>
AS-FND24D-B	Vertical hoisting			<ul style="list-style-type: none"> <li>1 meter round Plastic tube</li> <li>1 pc Vertical Hoisting installation aluminum end cap</li> <li>1 pc 1 meter Conductive Steel Rope with cable inside</li> <li>1 pc aluminum end cap without hole</li> <li>2 pcs silicone end caps (1pc with hole, 1pc without hole)</li> <li>7 pcs screws</li> <li>1 pc white plastic anchors</li> <li>1 pc Phillips screwdriver</li> </ul>
AS-FND24D-C	Double-head ceiling			<ul style="list-style-type: none"> <li>2 pcs Vertical Ceiling installation aluminum end caps</li> <li>2 pcs fixed aluminum end caps</li> <li>2 pcs silicone end caps (1pc with hole, 1pc without hole)</li> <li>10 pcs screws</li> <li>4 pcs white plastic anchors</li> <li>1 pc Phillips screwdriver</li> <li>1 pc M4 hexagonal wrench</li> </ul>
AS-FND24D-D	Horizontal hoisting			<ul style="list-style-type: none"> <li>1 meter round Plastic tube assembled with hanging clips</li> <li>2 pcs steel rope with copper bolts</li> <li>2 pcs screws for steel rope bolts</li> <li>2 pcs silicone end caps (1pc with hole, 1pc without hole)</li> <li>2 pcs white plastic anchors</li> </ul>
AS-FND24D-E	Round hoisting			<ul style="list-style-type: none"> <li>2 pcs thread locker</li> <li>2 pcs side outlet aluminum end caps</li> <li>2 pcs silicone end caps without hole</li> <li>7 pcs screws</li> <li>1 pcs plastic anchors</li> <li>1 pc Phillips screwdriver</li> </ul>
AS-ND24D-F	Telescopic rod ceiling			<ul style="list-style-type: none"> <li>1 set of assembled telescopic rods (the telescopic distance can be adjusted between 300MM-600MM)</li> <li>1 pc white plastic anchors</li> <li>1 pc screw</li> </ul>
AS-FND24D-G	Steel Rope Ceiling			<ul style="list-style-type: none"> <li>1 pc 1.5m assembled steel rope (including 30MM round PC tube + 30MM PC clips + 2pcs copper bolts)</li> <li>1 pc screw</li> <li>1 pc white plastic anchors</li> </ul>
AS-FND24D-H	Wall Mounting			<ul style="list-style-type: none"> <li>1 pc Vertical Ceiling installation aluminum end cap</li> <li>1 pcs fixed aluminum end cap</li> <li>2 pcs silicone end caps (1pc with hole, 1pc without hole)</li> <li>3 pcs 30MM PC clips</li> <li>11 pcs screws</li> <li>2 pcs white plastic anchors</li> <li>1 pc Phillips screwdriver</li> <li>1 pc M4 hexagonal wrench</li> </ul>



## ND26



### FEATURES

- Product size:  $\Phi$ 26mm
- Material: Silicone
- Length/reel: 100m/reel
- PCB width: 10mm
- Weight/Reel: 44.5KG
- Outer package size: 51\*51\*40cm
- Color: White and customized color

### PRODUCT SIZE

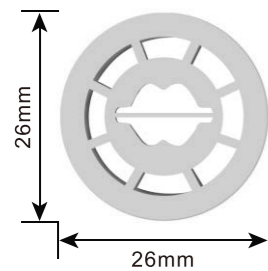

### STANDARD ACCESSORIES



Product body



End Cap x2

1 with holes

1 without hole

### SCENE DISPLAY

PS: Below is silicone tube with 2 lines led strips pcb back to back inside

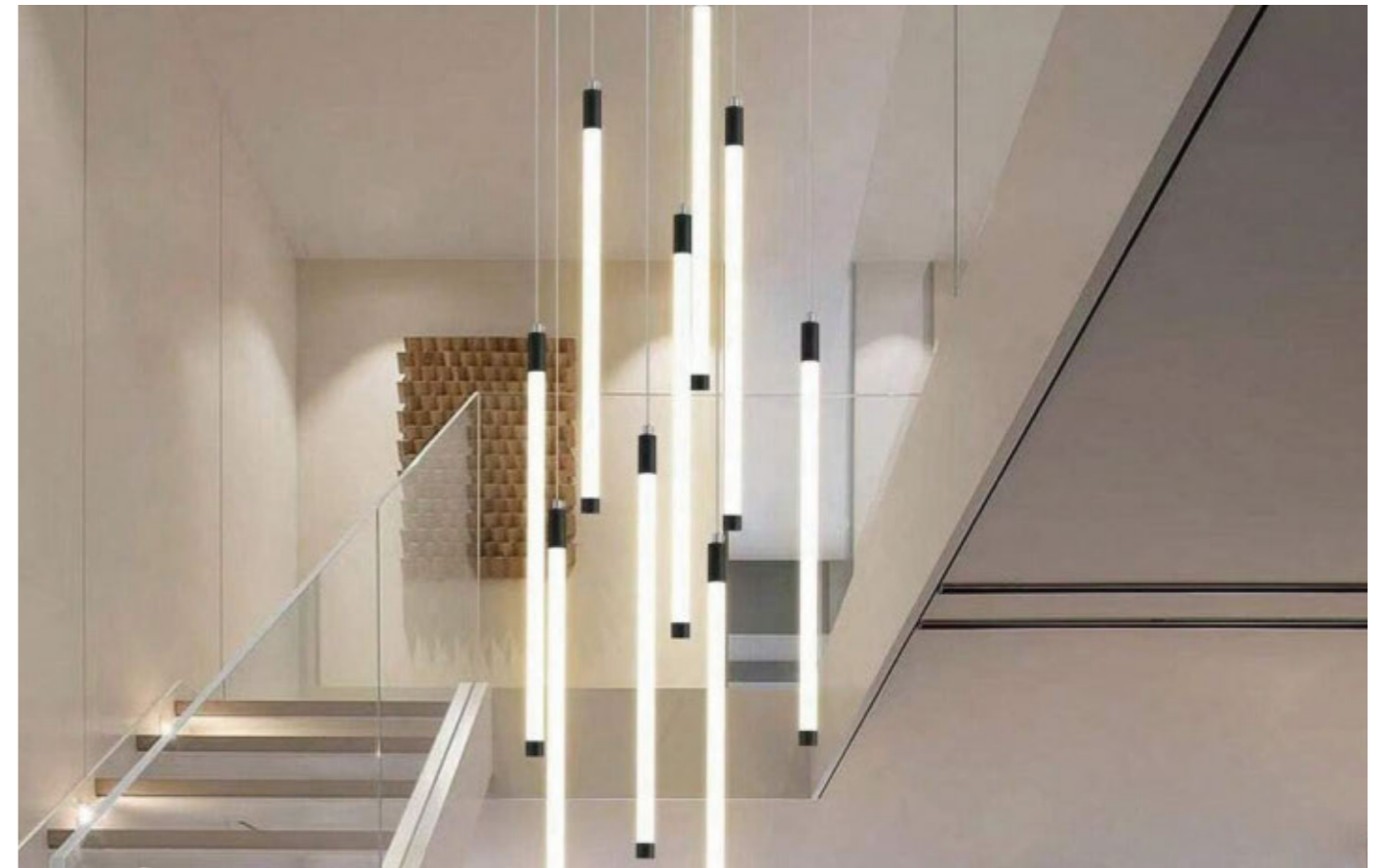
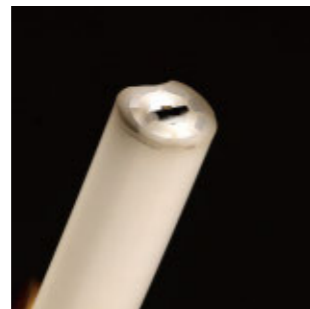



## ND33



### FEATURES

Product size:  $\Phi$ 33mm  
 Material: Silicone  
 Length/reel: 50m/reel  
 PCB width: 8mm  
 Weight/Reel: 36.5KG  
 Outer package size: 51\*51\*40cm  
 Color: White and customized color



## ND40



### FEATURES

Product size:  $\Phi$ 40mm  
 Material: Silicone  
 Length/reel: 50m/reel  
 PCB width: 8mm  
 Weight/Reel: 49.8KG  
 Outer package size: 53\*53\*40cm  
 Color: White and customized color

### PRODUCT SIZE

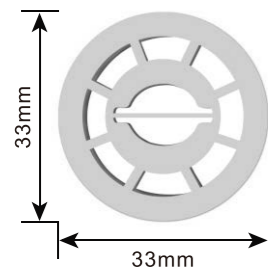

### PRODUCT SIZE

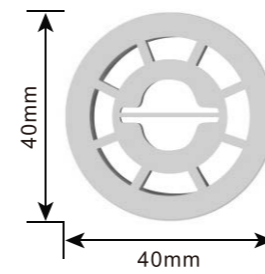

### STANDARD ACCESSORIES



Product body  
 End Cap x2  
 1 with holes  
 1 without hole  
 End Cap x2

### STANDARD ACCESSORIES



Product body  
 End Cap x2  
 1 with holes  
 1 without hole

### SCENE DISPLAY

PS: Below is silicone tube with 2 lines led strips pcb back to back inside



### SCENE DISPLAY

PS: Below is silicone tube with 2 lines led strips pcb back to back inside







## N2010



### FEATURES

- Product size: 20\*10mm
- Material: Silicone
- Length/reel: 100m/reel
- PCB width: 10-12mm
- Weight/Reel: 21.5KG
- Outer package size: 46\*46\*20cm
- Color: White and customized color



## N2014



### FEATURES

- Product size: 20\*14mm
- Material: Silicone
- Length/reel: 100m/reel
- PCB width: 12-15mm
- Weight/Reel: 23.8KG
- Outer package size: 50\*50\*20cm
- Color: White and customized color

### PRODUCT SIZE

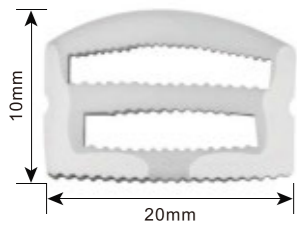

### PRODUCT SIZE

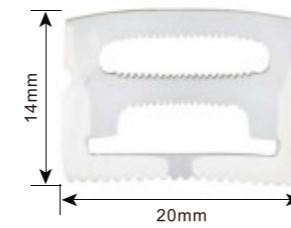

### STANDARD ACCESSORIES

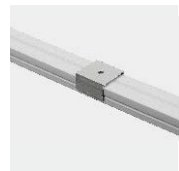

Product body



End Cap x2

1 with holes

1 without hole



Mounting Clip

Metal

### SCENE DISPLAY

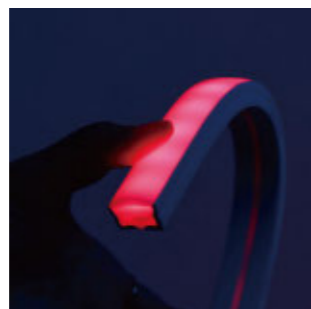

### STANDARD ACCESSORIES



Product body



End Cap x2

1 with holes

1 without hole



Mounting Clip

Metal

### SCENE DISPLAY

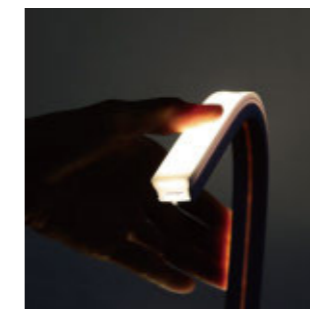
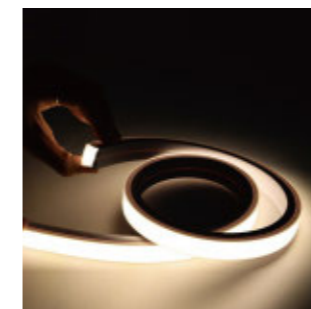



## N2020



### FEATURES

- Product size: 20\*20mm
- Material: Silicone
- Length/reel: 100m/reel
- PCB width: 10-12mm
- Weight/Reel: 30.5KG
- Outer package size: 41\*41\*40cm
- Color: White and customized color



## N3020



### FEATURES

- Product size: 30\*20mm
- Material: Silicone
- Length/reel: 100m/reel
- PCB width: 16-18mm
- Weight/Reel: 44.5KG
- Outer package size: 51\*51\*40cm
- Color: White and customized color

### PRODUCT SIZE

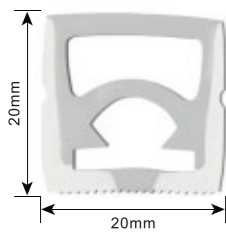

### PRODUCT SIZE

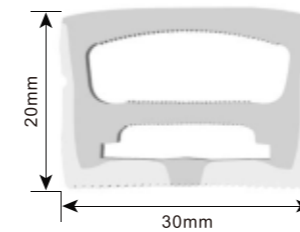

### STANDARD ACCESSORIES



Product body



End Cap x2

- 1 with holes
- 1 without hole



Mounting Clip

Metal

### SCENE DISPLAY

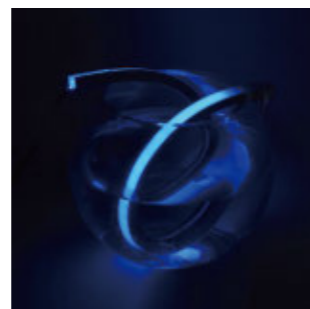

### STANDARD ACCESSORIES



Product body



End Cap x2

- 1 with holes
- 1 without hole



Mounting Clip

Metal

### SCENE DISPLAY

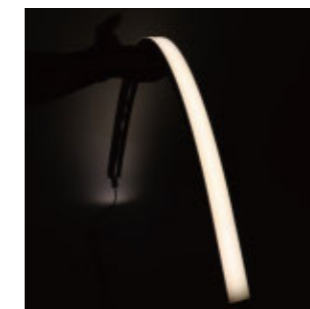



## N5025



### FEATURES

- Product size: 50\*25mm
- Material: Silicone
- Length/reel: 50m/reel
- PCB width: 18-20mm
- Weight/Reel:34.5KG
- Outer package size: 51\*51\*40cm
- Color: White and customized color

### PRODUCT SIZE

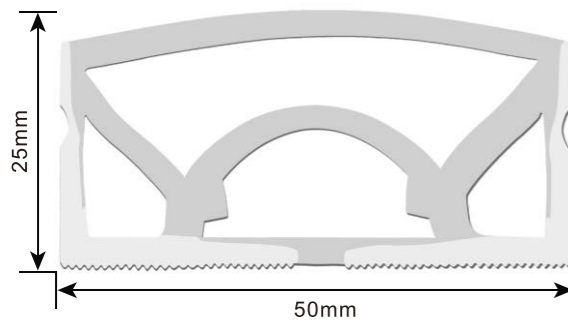

### STANDARD ACCESSORIES



Product body



End Cap x2

1 with holes  
1 without hole



Mounting Clip

Metal

### SCENE DISPLAY

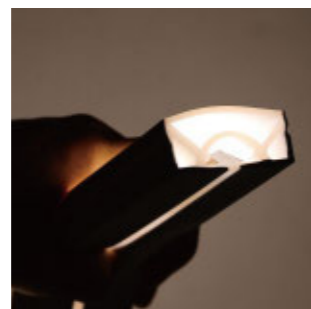

## N0410B



### FEATURES

- Product size: 4\*10mm
- PCB width: 4-7mm
- IP Grade: IP67
- N.W.(G/M): 35g
- Material: Silicone
- Length/reel: 100m/reel
- Working Temperature: -20 to 50°C
- Color: White and customized color

### PRODUCT SIZE

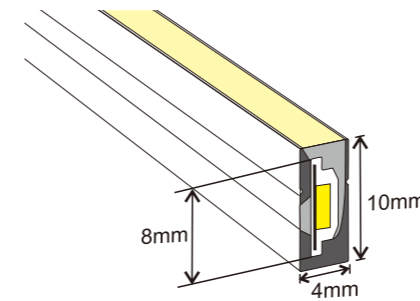

### STANDARD ACCESSORIES



Product body



End Cap x2

1 with holes  
1 without hole



Mounting Clip

Plastic

### SCENE DISPLAY

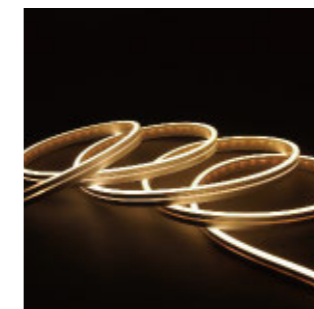

## N0513



### FEATURES

- Product size: 5\*13mm
- Material: Silicone
- Length/reel: 100m/reel
- PCB width: 8-10mm
- IP Grade: IP67
- Color: White and customized color



### PRODUCT SIZE

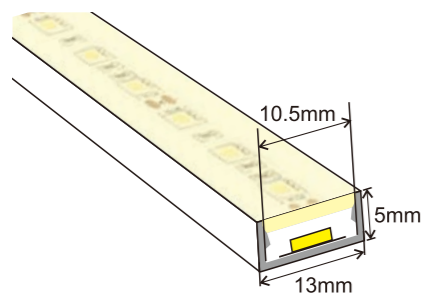

### STANDARD ACCESSORIES



Product body

End Cap x2  
1 with holes  
1 without hole

### SCENE DISPLAY



## N0612P



### FEATURES

- Product size: 6\*12mm
- PCB width: 8mm
- IP Grade: IP67
- N.W.(G/M): 75g
- Material: Silicone
- Length/reel: 100m/reel
- Working Temperature: -20 to 50°C
- Color: White and customized color



### PRODUCT SIZE

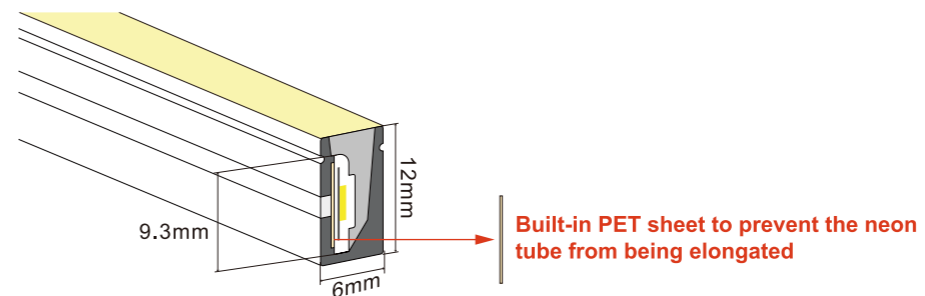

### STANDARD ACCESSORIES



Product body

End caps without hole

Cable bottom output

Cable output from side

Straight cable output

Mounting Clip  
Metal

### SCENE DISPLAY



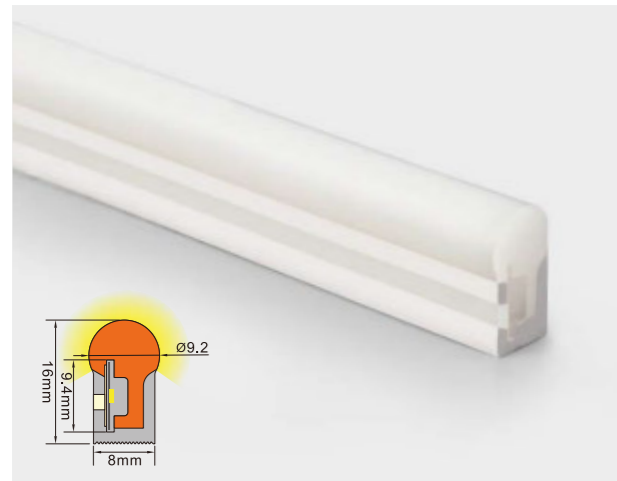

## N0816P



### FEATURES

- Product size: 8\*16mm
- PCB width: 8mm
- IP Grade: IP67
- N.W.(G/M): 145g
- Material: Silicone
- Length/reel: 100m/reel
- Working Temperature: -20 to 50°C
- Color: White and customized color

### PRODUCT SIZE

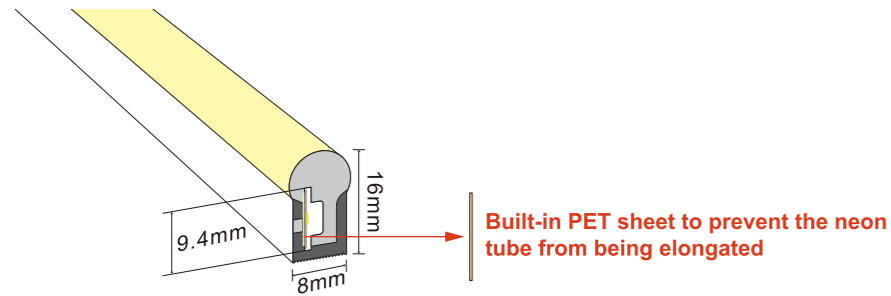

### STANDARD ACCESSORIES



### SCENE DISPLAY

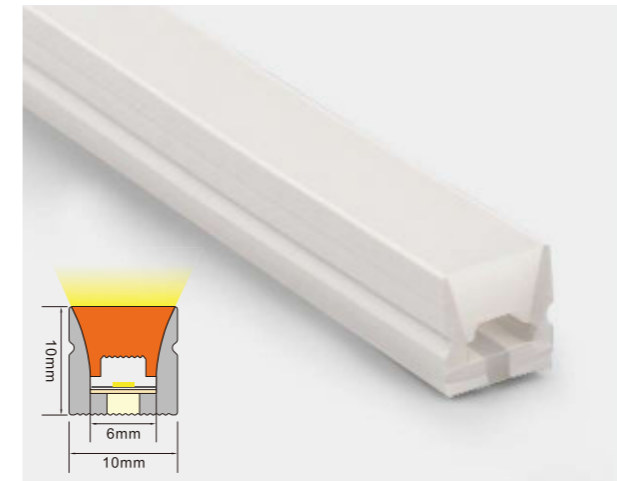
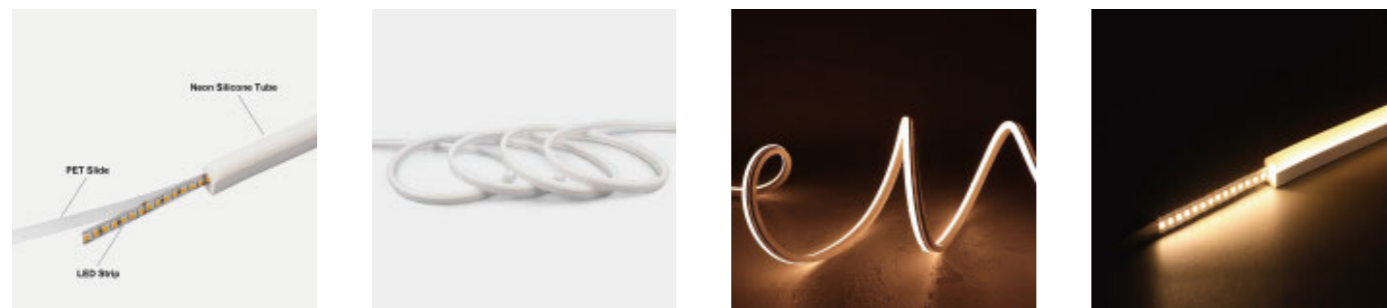

## N1010P-TOP



### FEATURES

- Product size: 10\*10mm
- PCB width: 5mm
- IP Grade: IP67
- N.W.(G/M): 99g
- Material: Silicone
- Length/reel: 100m/reel
- Working Temperature: -20 to 50°C
- Color: White and customized color

### PRODUCT SIZE

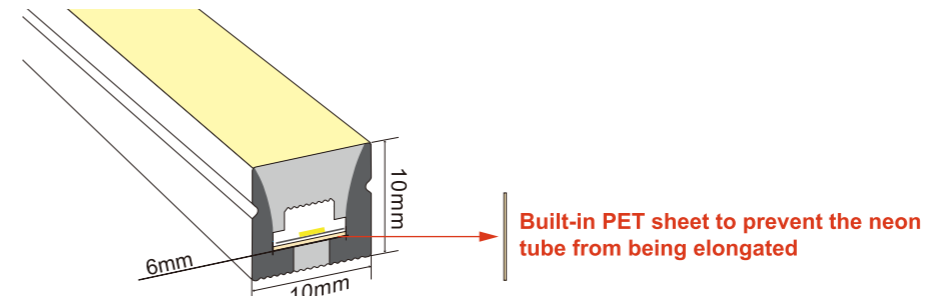

### STANDARD ACCESSORIES

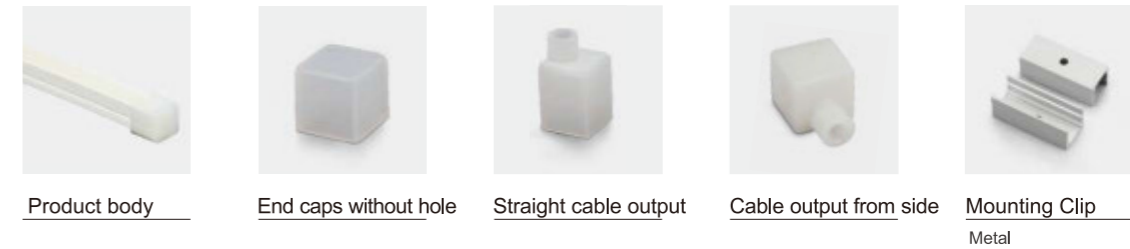

### SCENE DISPLAY

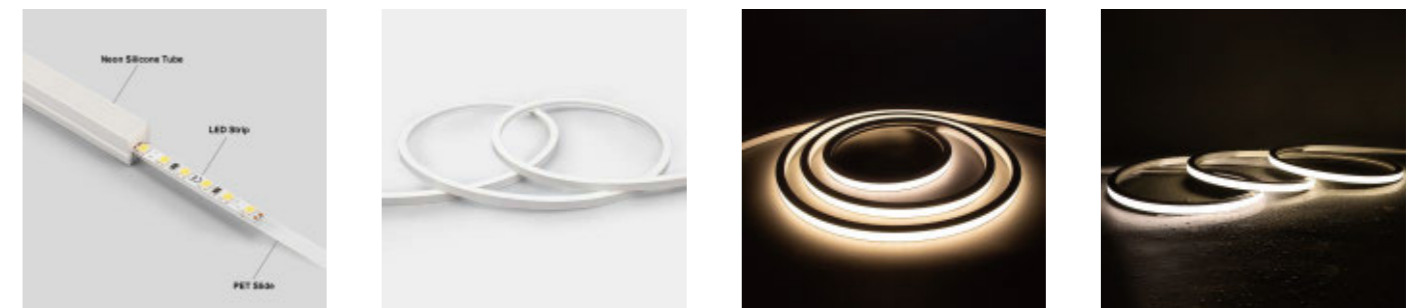

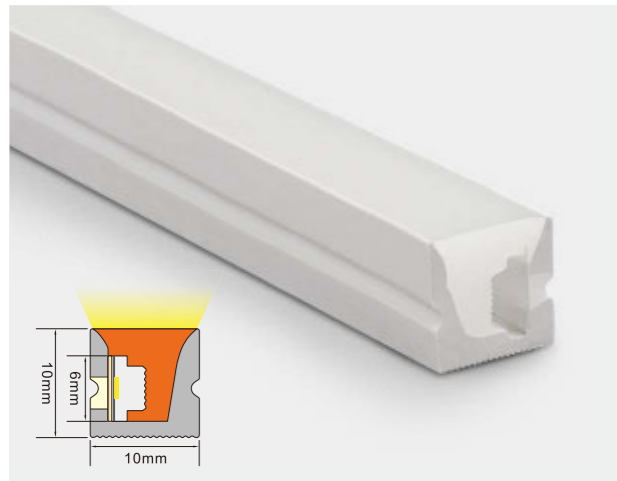

## N1010P-SIDE



### FEATURES

- Product size: 10\*10mm
- PCB width: 5mm
- IP Grade: IP67
- N.W.(G/M): 96g
- Material: Silicone
- Length/reel: 100m/reel
- Working Temperature: -20 to 50°C
- Color: White and customized color

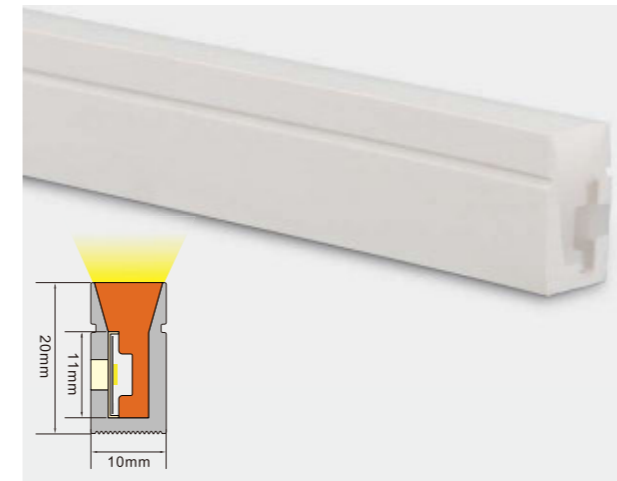

## N1020P



### FEATURES

- Product size: 10\*20mm
- PCB width: 10mm
- IP Grade: IP67
- N.W.(G/M): 220g
- Material: Silicone
- Length/reel: 50m/reel
- Working Temperature: -20 to 50°C
- Color: White and customized color

### PRODUCT SIZE

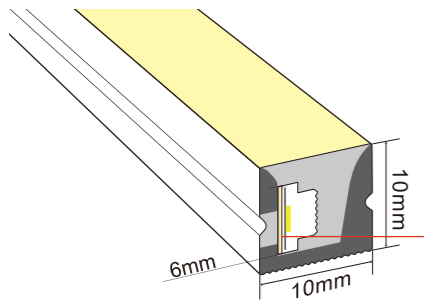

Built-in PET sheet to prevent the neon tube from being elongated

### PRODUCT SIZE

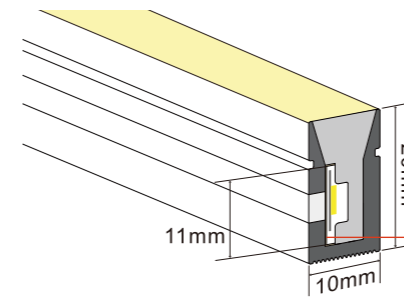

Built-in PET sheet to prevent the neon tube from being elongated

### STANDARD ACCESSORIES

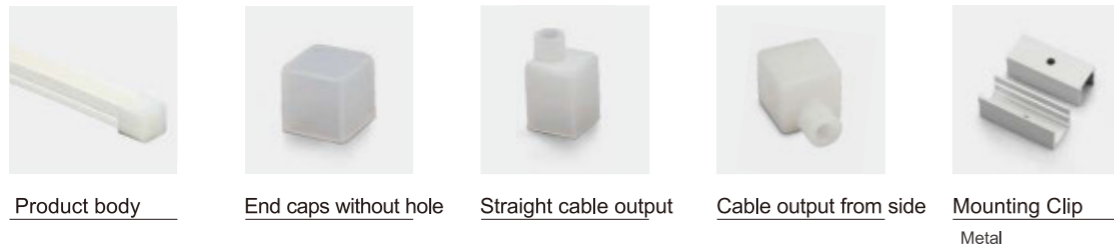

### STANDARD ACCESSORIES

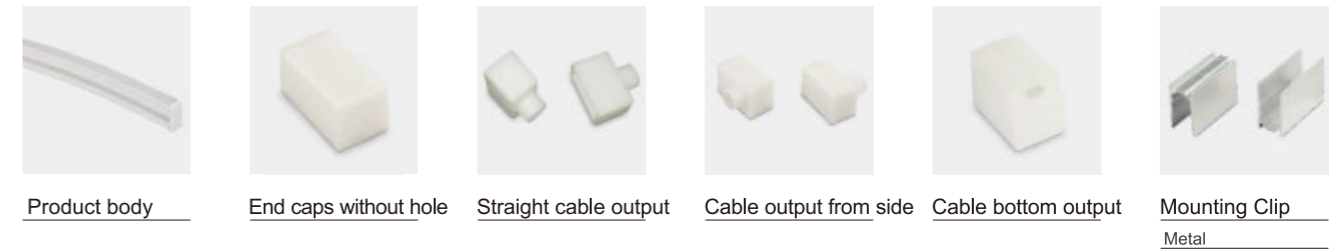

### SCENE DISPLAY

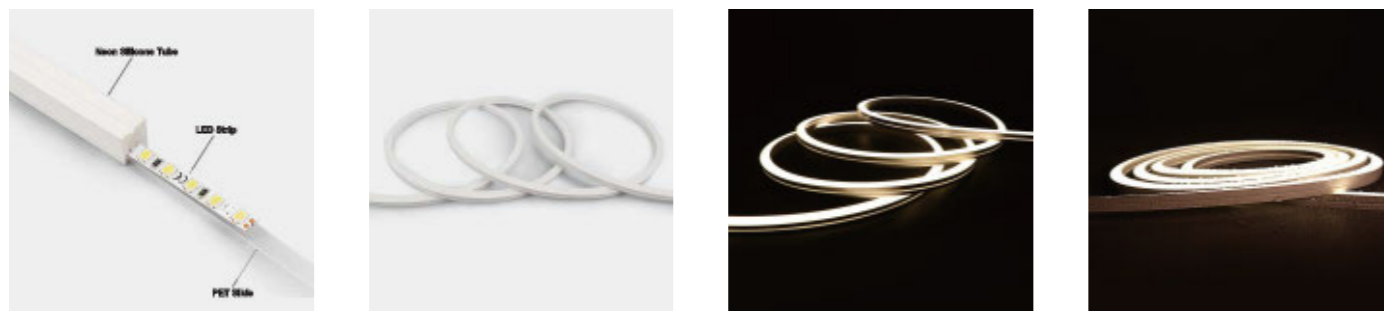

### SCENE DISPLAY

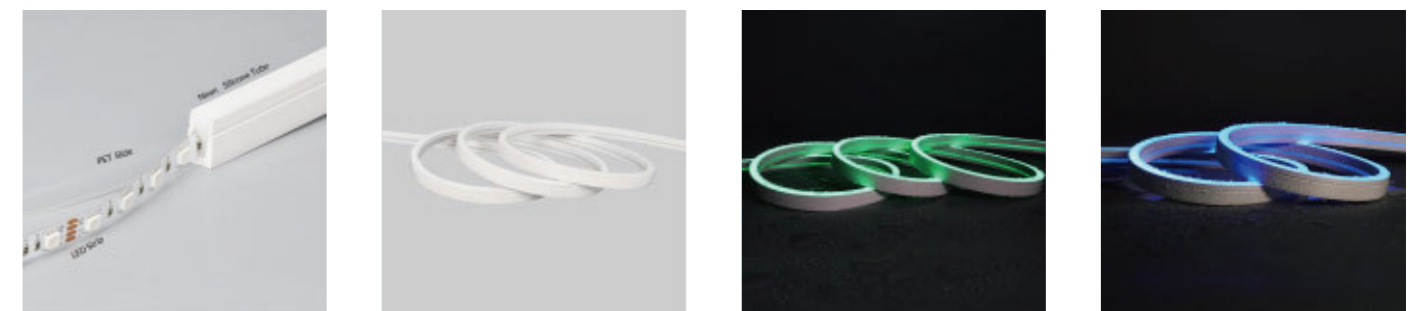



## N1023P



### FEATURES

- Product size: 10\*23mm
- PCB width: 10mm
- IP Grade: IP67
- N.W.(G/M): 220g
- Material: Silicone
- Length/reel: 50m/reel
- Working Temperature: -20 to 50°C
- Color: White and customized color

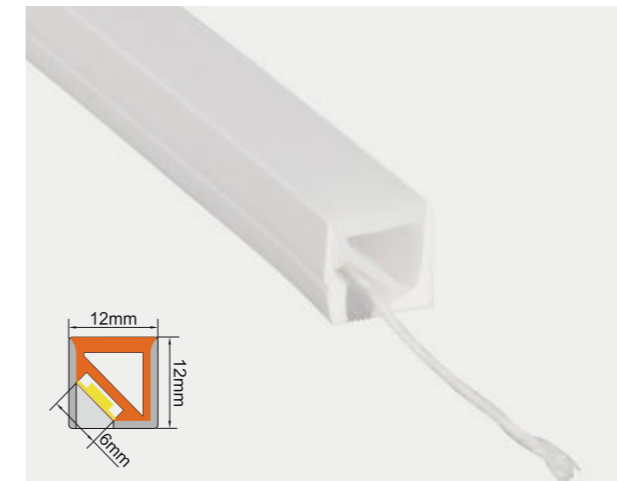

## N1212P-3D



### FEATURES

- Product size: 12\*12mm
- PCB width: 6mm
- IP Grade: IP67
- N.W.(G/M): 195g
- Material: Silicone
- Length/reel: 50m/reel
- Working Temperature: -20 to 50°C
- Color: White and customized color

### PRODUCT SIZE

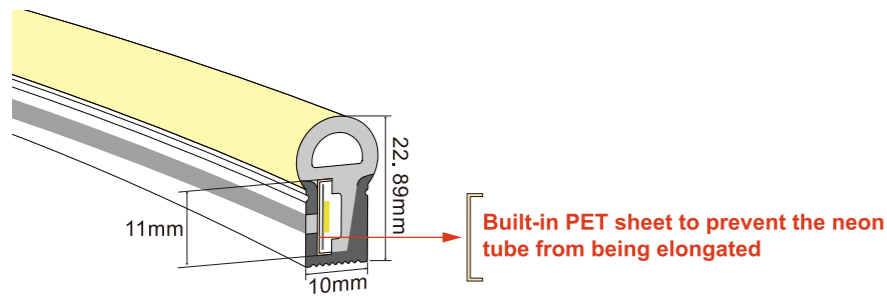

### PRODUCT SIZE

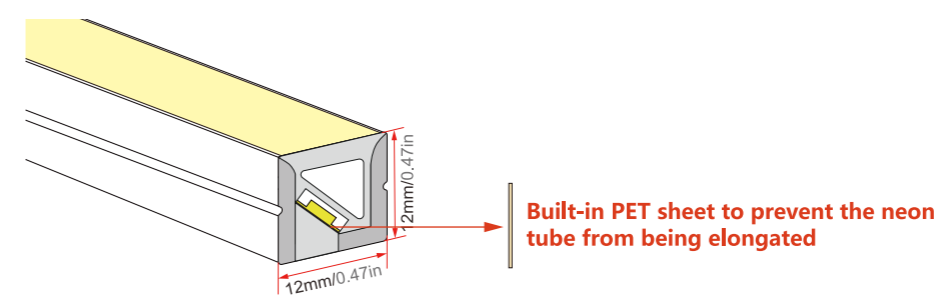

### STANDARD ACCESSORIES

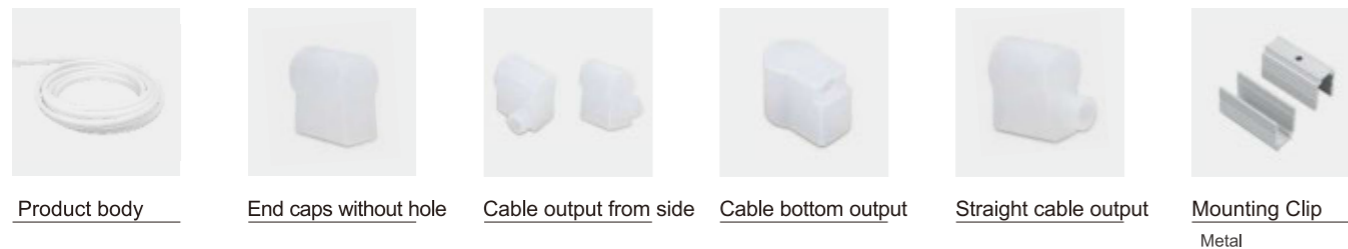

### STANDARD ACCESSORIES

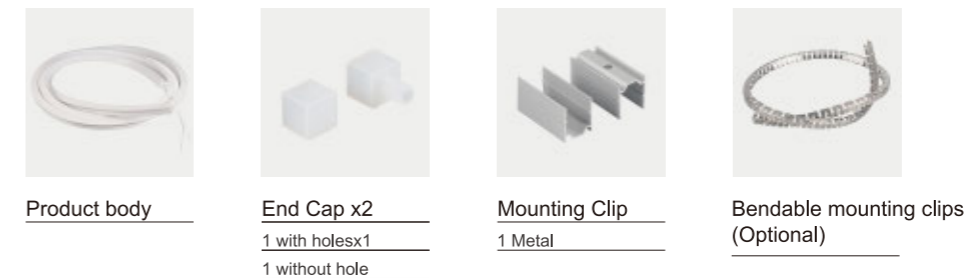

### SCENE DISPLAY



### SCENE DISPLAY



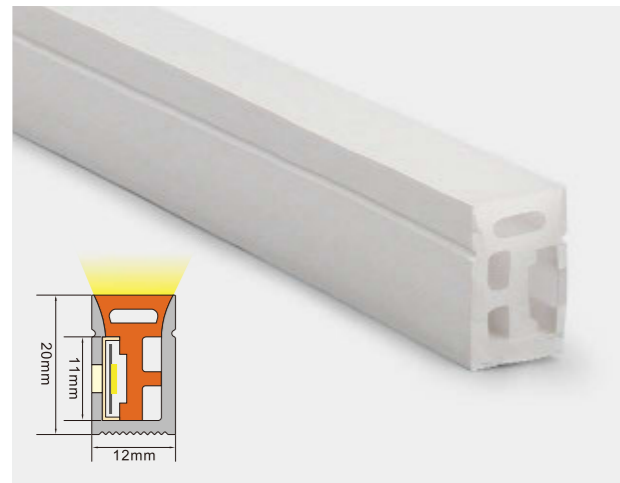

## N1220P



### FEATURES

- Product size: 12\*20mm
- PCB width: 10mm
- IP Grade: IP67
- N.W.(G/M): 230g
- Material: Silicone
- Length/reel: 50m/reel
- Working Temperature: -20 to 50°C
- Color: White and customized color

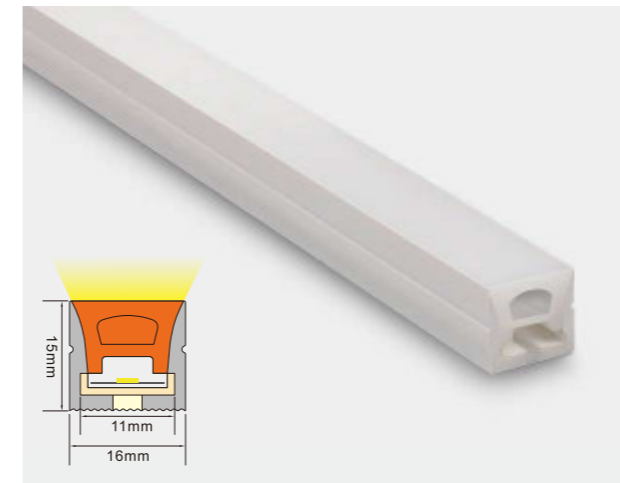

## N1615P



### FEATURES

- Product size: 16\*15mm
- PCB width: 10mm
- IP Grade: IP67
- N.W.(G/M): 210g
- Material: Silicone
- Length/reel: 50m/reel
- Working Temperature: -20 to 50°C
- Color: White and customized color

### PRODUCT SIZE

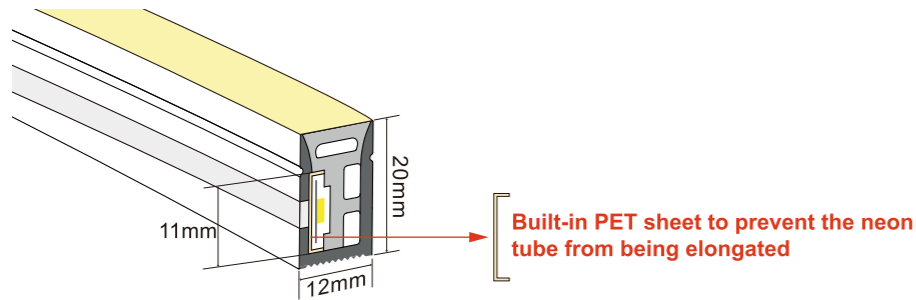

### PRODUCT SIZE

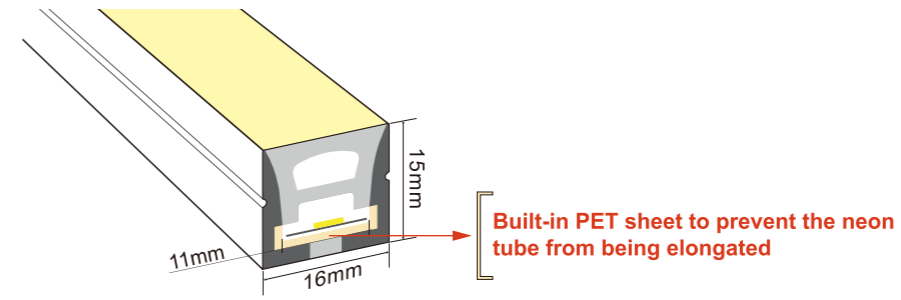

### STANDARD ACCESSORIES

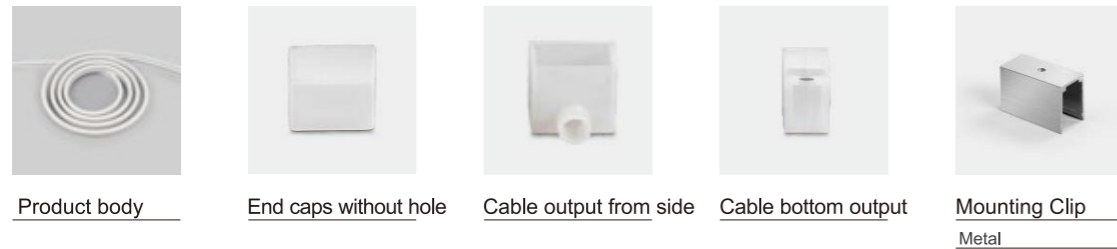

### STANDARD ACCESSORIES



### SCENE DISPLAY

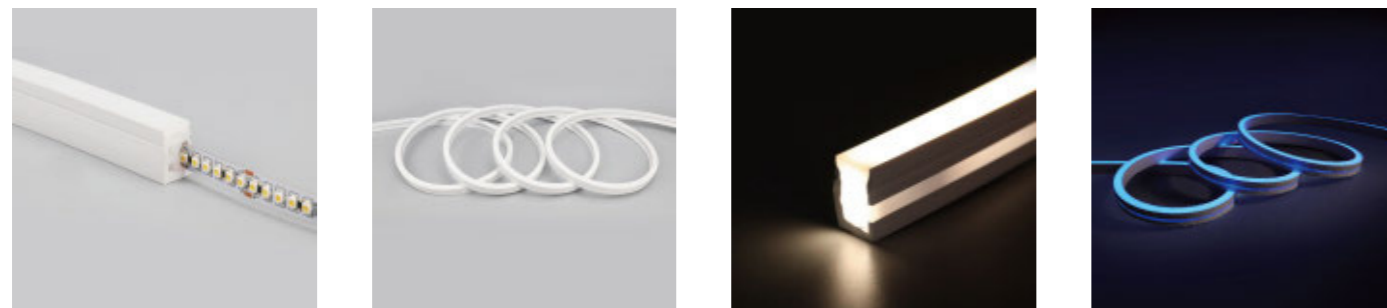

### SCENE DISPLAY







## N1326



### FEATURES

- Product size: 13\*26mm
- Material: Silicone
- Length/reel: 50m/reel
- PCB width: 10-12mm
- IP Grade: IP67
- Color: White and customized color



## N2515



### FEATURES

- Product size: 25\*15mm
- Material: Silicone
- Length/reel: 50m/reel
- PCB width: 15-18mm
- IP Grade: IP67
- Color: White and customized color

### PRODUCT SIZE

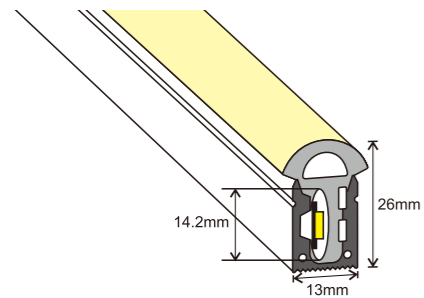

### PRODUCT SIZE

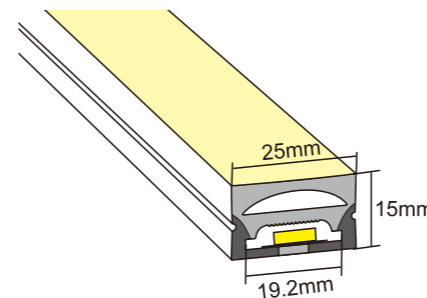

### STANDARD ACCESSORIES



### STANDARD ACCESSORIES

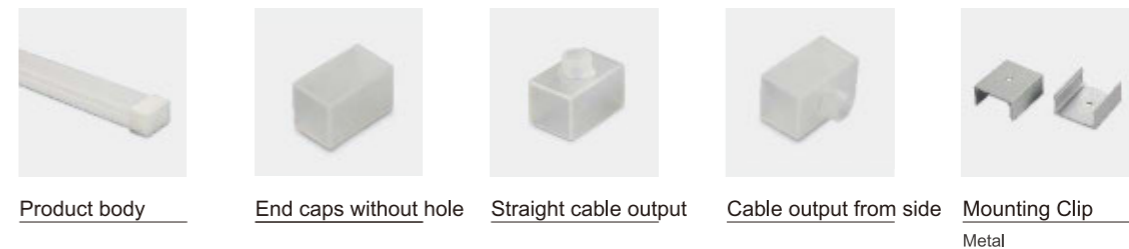

### SCENE DISPLAY

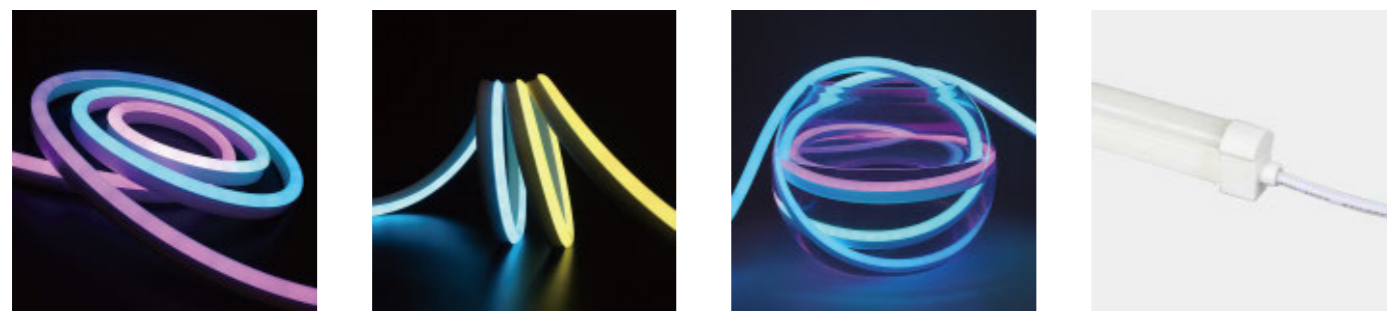

### SCENE DISPLAY



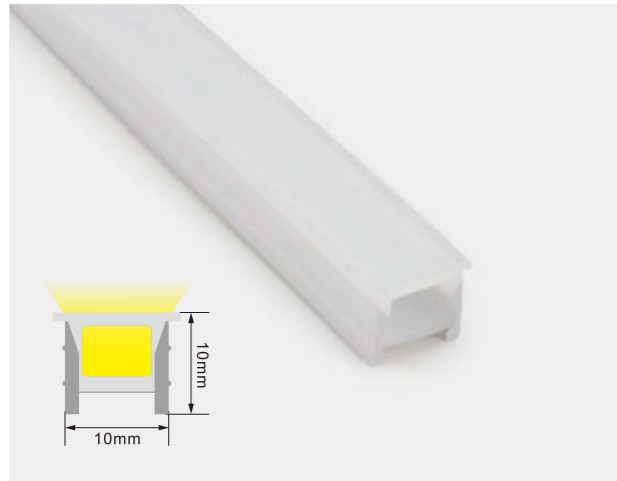

## NC1010



### FEATURES

- Product size: 10\*10mm
- PCB width: 8mm
- Material: Silicone
- Length/reel: 100m/reel
- Light transmittance: 50%
- Working Temperature: -20 to 50°C
- Color: White and customized color

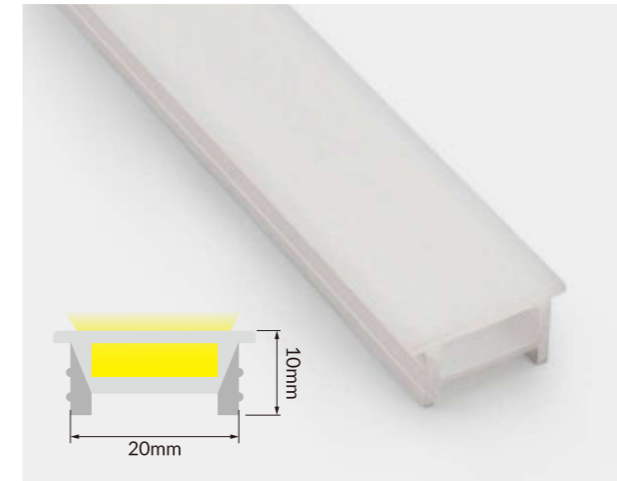

## NC2010



### FEATURES

- Product size: 10\*20mm
- PCB width: 10-15mm
- Material: Silicone
- Length/reel: 100m/reel
- Light transmittance: 50%
- Working Temperature: -20 to 50°C
- Color: White and customized color

### INSTALLATION STEPS

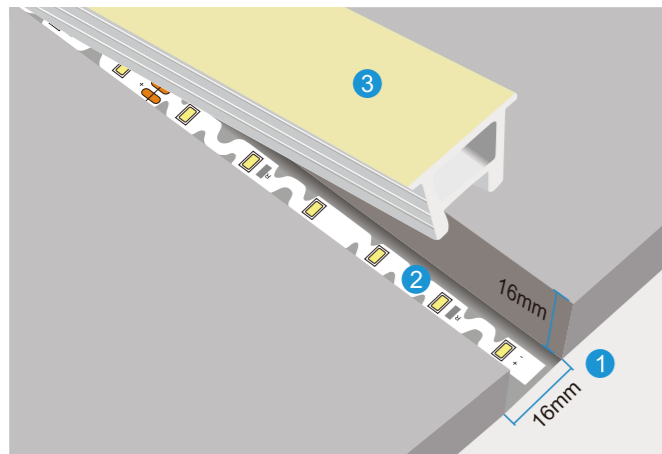

- 1 Slot according to the size, the error should be small
- 2 Tear off double-sided tape at back and stick the light strip to the wall
- 3 Press the cover into the wall. When the light is turned on, the cover has high light transmittance and high temperature resistance. The light strip and the cover are installed separately, which makes the DIY operation space more

### INSTALLATION STEPS

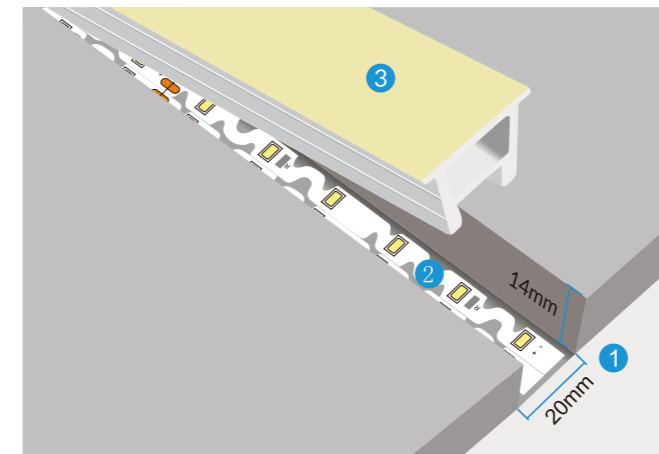

- 1 Slot according to the size, the error should be small
- 2 Tear off double-sided tape at back and stick the light strip to the wall
- 3 Press the cover into the wall. When the light is turned on, the cover has high light transmittance and high temperature resistance. The light strip and the cover are installed separately, which makes the DIY operation space more

### SCENE DISPLAY



### SCENE DISPLAY



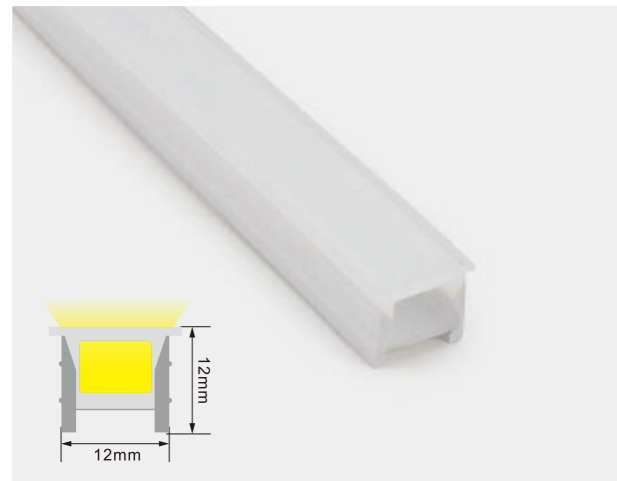

## NC1212



### FEATURES

- Product size: 12\*12mm
- PCB width: 8mm
- Material: Silicone
- Length/reel: 100m/reel
- Light transmittance: 50%
- Working Temperature: -20 to 50°C
- Color: White and customized color

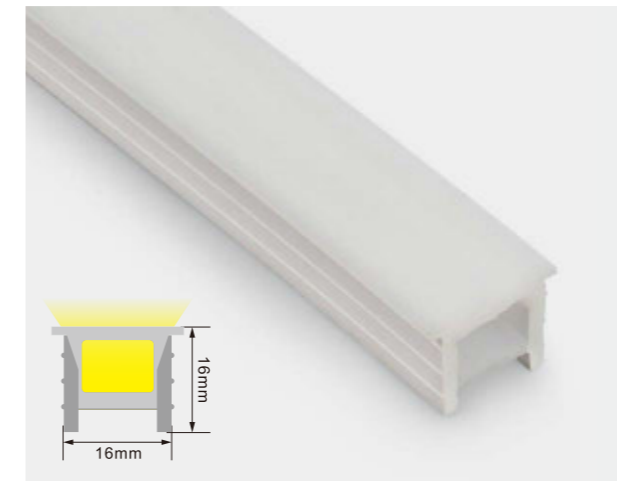

## NC1616



### FEATURES

- Product size: 16\*16mm
- PCB width: 10-12mm
- Material: Silicone
- Length/reel: 100m/reel
- Light transmittance: 50%
- Working Temperature: -20 to 50°C
- Color: White and customized color

### INSTALLATION STEPS

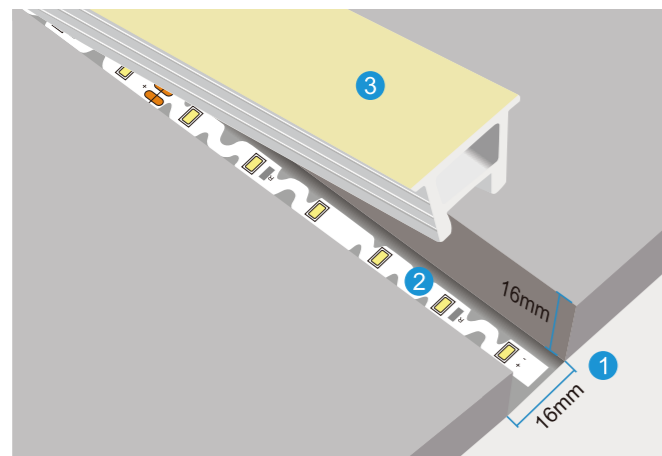

- 1 Slot according to the size, the error should be small
- 2 Tear off double-sided tape at back and stick the light strip to the wall
- 3 Press the cover into the wall. When the light is turned on, the cover has high light transmittance and high temperature resistance. The light strip and the cover are installed separately, which makes the DIY operation space more

### INSTALLATION STEPS

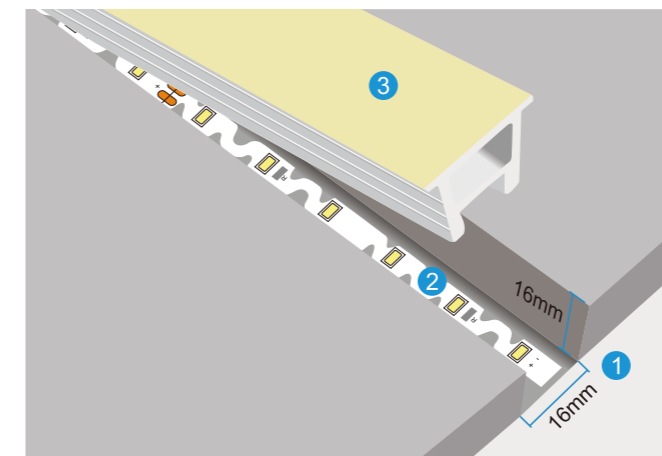

- 1 Slot according to the size, the error should be small
- 2 Tear off double-sided tape at back and stick the light strip to the wall
- 3 Press the cover into the wall. When the light is turned on, the cover has high light transmittance and high temperature resistance. The light strip and the cover are installed separately, which makes the DIY operation space more

### SCENE DISPLAY



### SCENE DISPLAY

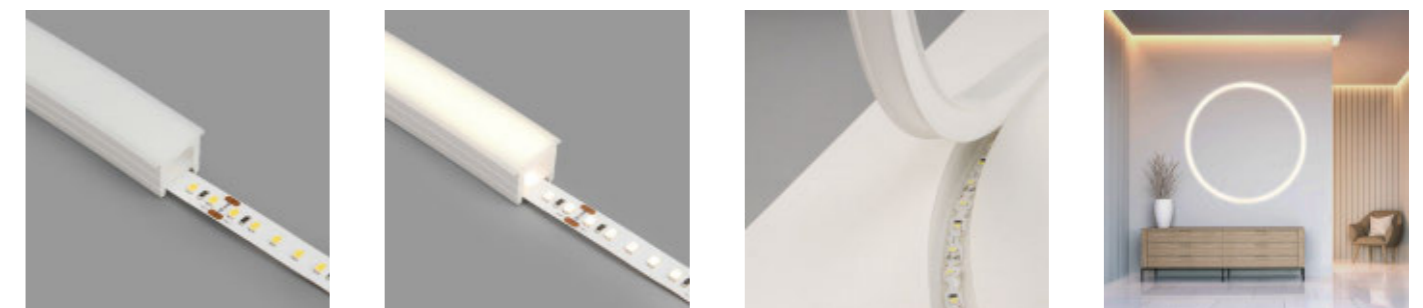

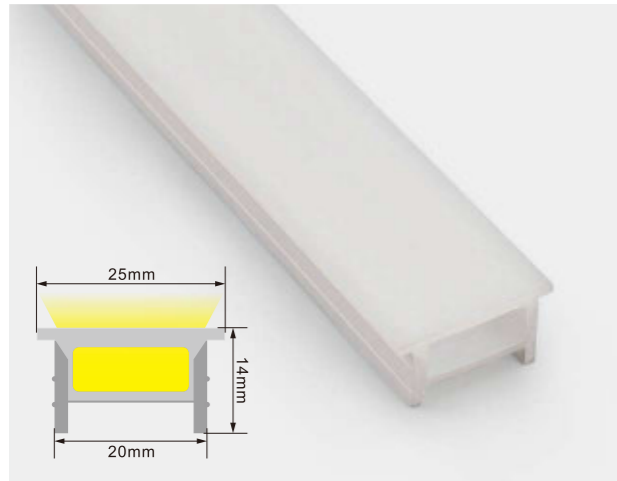

## NC2014



### FEATURES

- Product size: 20\*14mm
- PCB width: 10-15mm
- Material: Silicone
- Length/reel: 100m/reel
- Light transmittance: 50%
- Working Temperature: -20 to 50°C
- Color: White and customized color

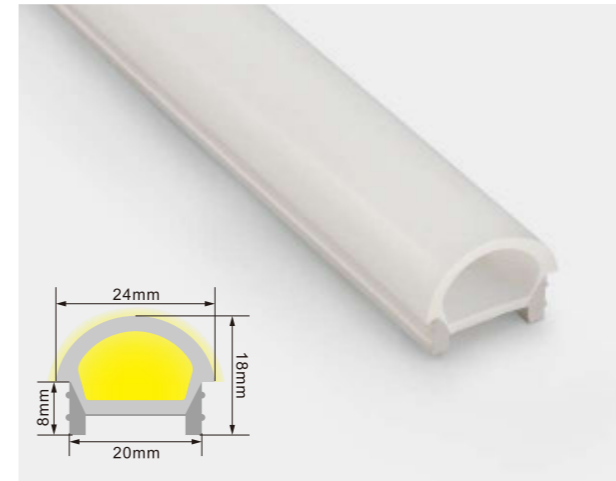

## NC2018



### FEATURES

- Product size: 24\*18mm
- PCB width: 10-15mm
- Material: Silicone
- Length/reel: 100m/reel
- Light transmittance: 56%
- Working Temperature: -20 to 50°C
- Color: White and customized color

### INSTALLATION STEPS

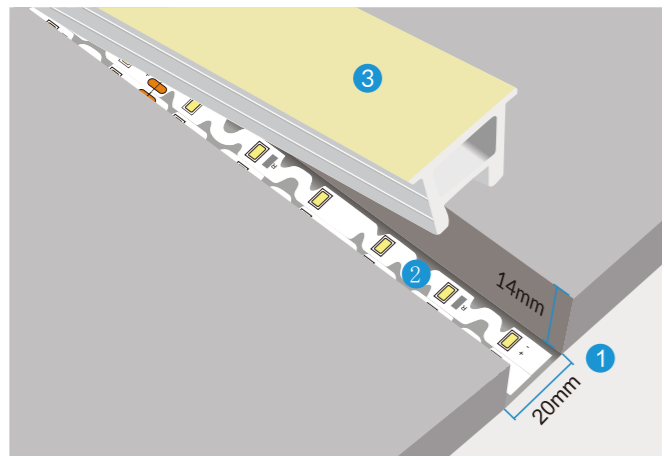

- 1 Slot according to the size, the error should be small
- 2 Tear off double-sided tape at back and stick the light strip to the wall
- 3 Press the cover into the wall. When the light is turned on, the cover has high light transmittance and high temperature resistance. The light strip and the cover are installed separately, which makes the DIY operation space more

### INSTALLATION STEPS

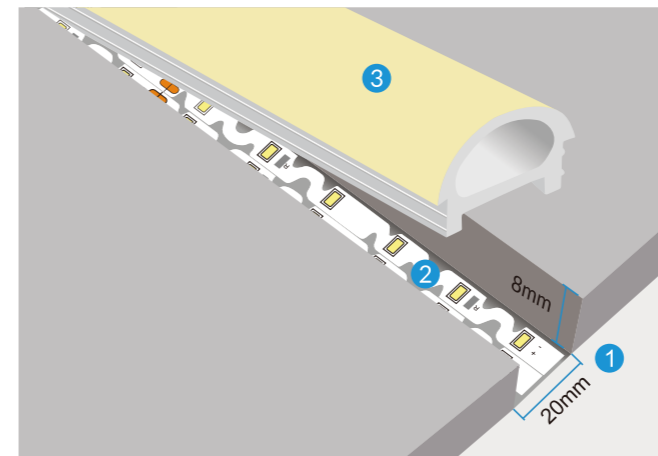

- 1 Slot according to the size, the error should be small
- 2 Tear off double-sided tape at back and stick the light strip to the wall
- 3 Press the cover into the wall. When the light is turned on, the cover has high light transmittance and high temperature resistance. The light strip and the cover are installed separately, which makes the DIY operation space more

### SCENE DISPLAY



### SCENE DISPLAY

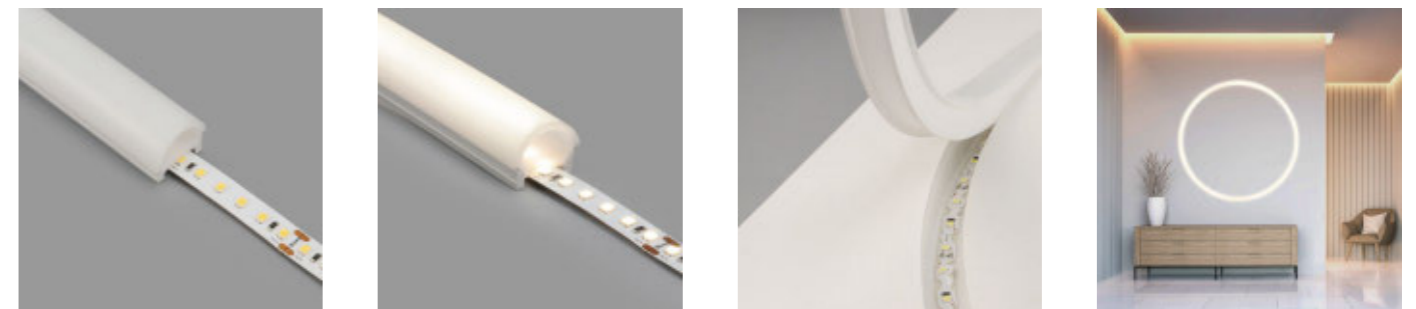

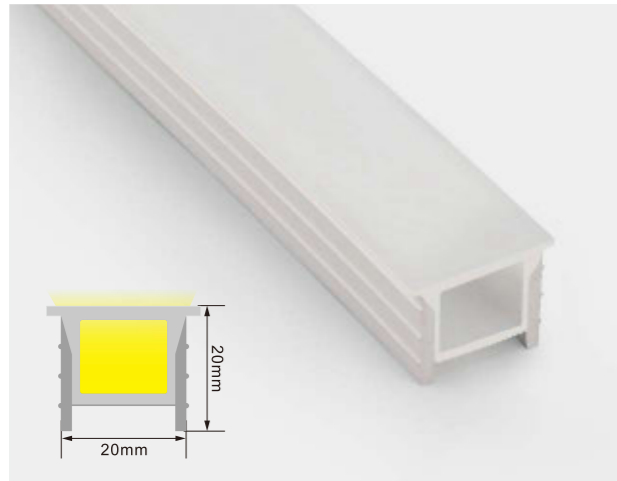

## NC2020



### FEATURES

- Product size: 20\*20mm
- PCB width: 10-15mm
- Material: Silicone
- Length/reel: 100m/reel
- Light transmittance: 45%
- Working Temperature: -20 to 50°C
- Color: White and customized color

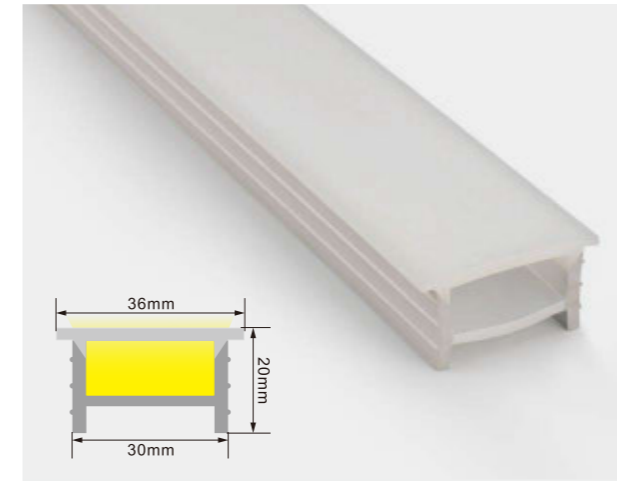

## NC3020



### FEATURES

- Product size: 30\*20mm
- PCB width: 10-20mm
- Material: Silicone
- Length/reel: 100m/reel
- Light transmittance: 45%
- Working Temperature: -20 to 50°C
- Color: White and customized color

### INSTALLATION STEPS

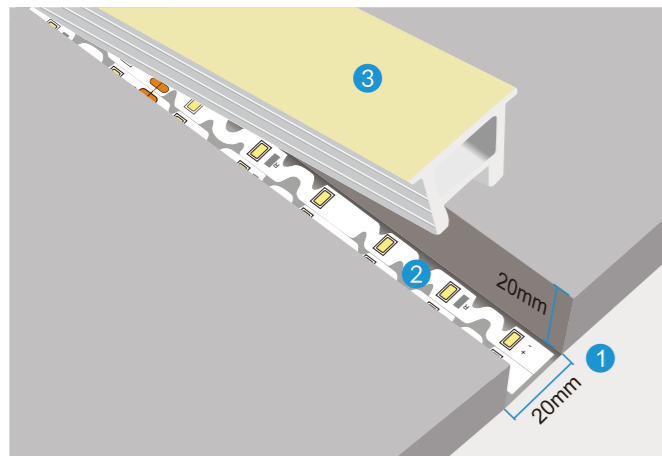

- 1 Slot according to the size, the error should be small
- 2 Tear off double-sided tape at back and stick the light strip to the wall
- 3 Press the cover into the wall. When the light is turned on, the cover has high light transmittance and high temperature resistance. The light strip and the cover are installed separately, which makes the DIY operation space more

### INSTALLATION STEPS

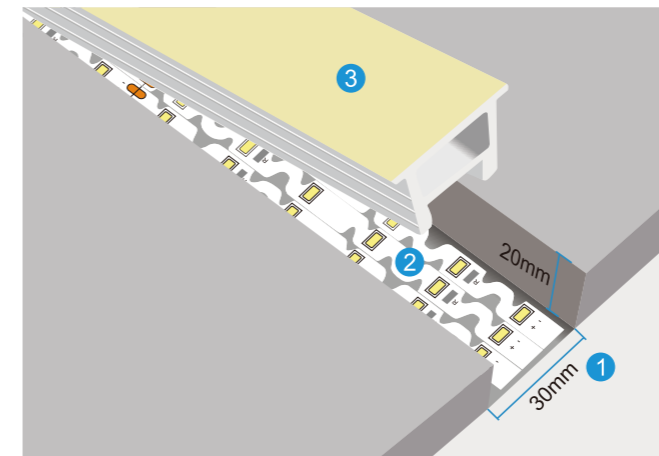

- 1 Slot according to the size, the error should be small
- 2 Tear off double-sided tape at back and stick the light strip to the wall
- 3 Press the cover into the wall. When the light is turned on, the cover has high light transmittance and high temperature resistance. The light strip and the cover are installed separately, which makes the DIY operation space more

### SCENE DISPLAY



### SCENE DISPLAY

