

Wardrobe Light R12 LED Strip

360 degree rotating, round surface-mounted luminaire. Composed of 12.2mm diameter housing aluminum, SMD2835 single color 120leds/m LED Strip, Led diffuser PC cover, power cable and plug, endcaps and clips. Easy installation with screws and magnet, Suitable lighting for shelves, cabinets, wardrobes, display case, etc

Round LED Profile with LED							
Model	Power	Lumens	Ra	CCT(K)	Length	Voltage	LED Type
R12-400-WW	4.8W	385	>80	3000K	410mm	DC24V	SMD2835-120LED/M
R12-400-NW	4.8W	400	>80	4000K	410mm	DC24V	SMD2835-120LED/M
R12-400-CW	4.8W	390	>80	6500K	410mm	DC24V	SMD2835-120LED/M

Customizable information			
Voltage	Power	Customizable length calculation formula	Example
DC12V	0.3*N	25*N+10mm (N=Integer) mm	25*40+10mm=Total length1010mm
DC24V	0.6*N	50*N+10mm (N=Integer) mm	50*20+10mm=Total length1010mm

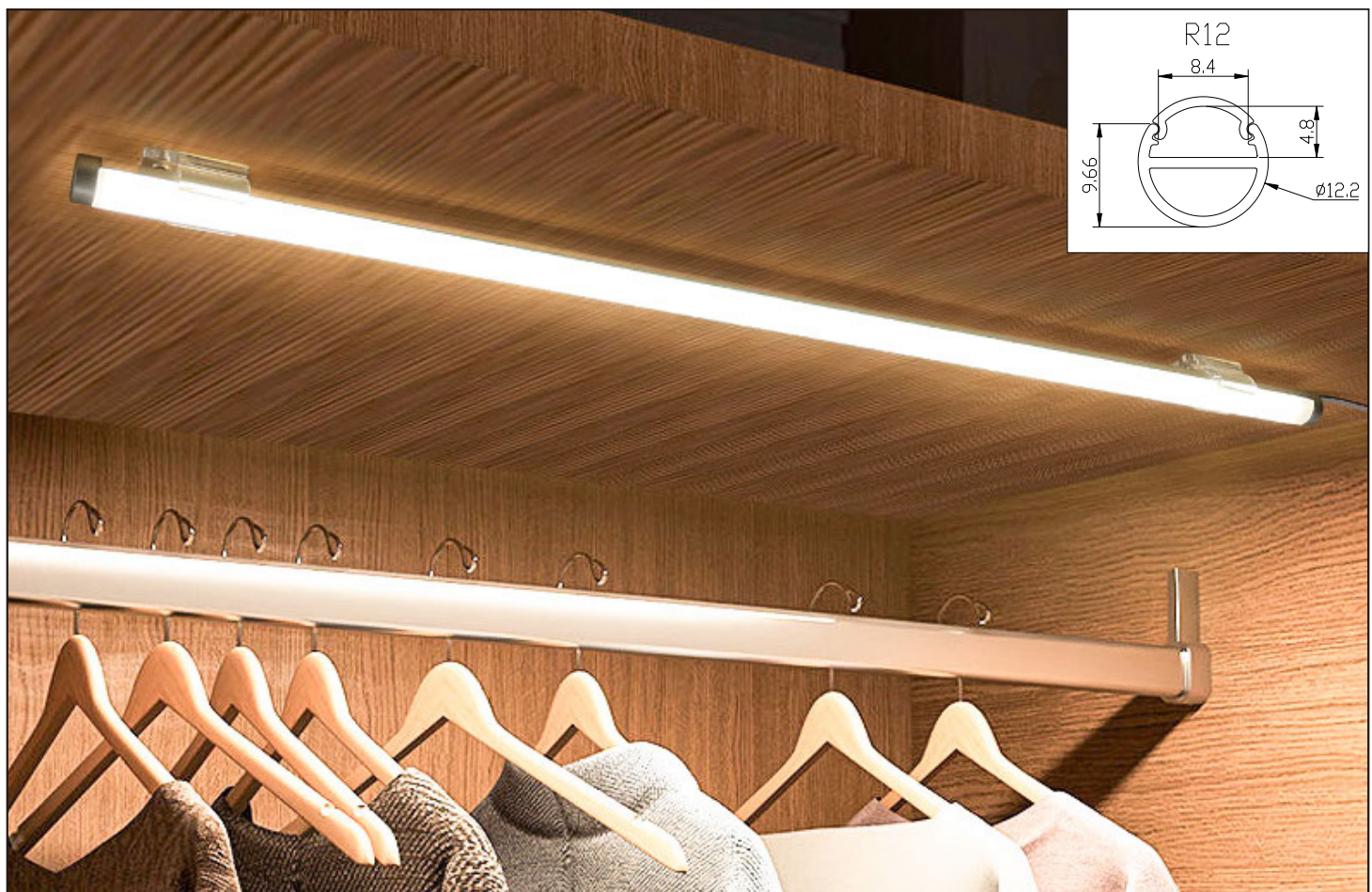

【 Basic Parameters 】

- Match Flexible LED Strips: Up to 8mm Wide.
- Material: Anodized Aluminum Extrusion.
- Cover: Led diffuser PC cover
- Length: 410mm
- Mounting: Surface.
- Input voltage: DC24V
- Working temperature: -20°C~50°C
- CCT: 3000/4000/6500K optional
- CRI: >80
- Color: Silver
- Application: Indoor

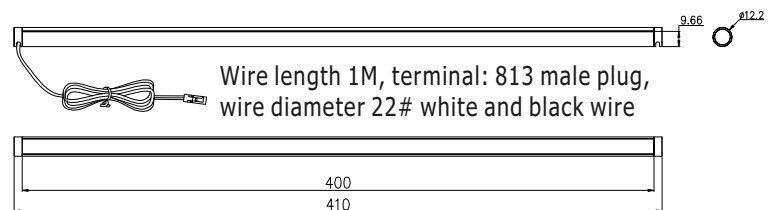

【 Special features 】

- Special features: LEDs rotating 360°
- Assembly with screws in wood or with magnet holding clip as accessory

【 2835 Single color 120LED/METER 】

- Input voltage: 24VDC.
- Power: 12W/M.
- CCT: 3000K/4000K/6500K
- CRI >80
- Lumens: 1320lm/M
- Waterproof: IP20



[Assembly dimensions]

Swivel and tilt LED linear luminaire, LEDs swivel and tilt 360°. Approved as a furniture luminaire in accordance

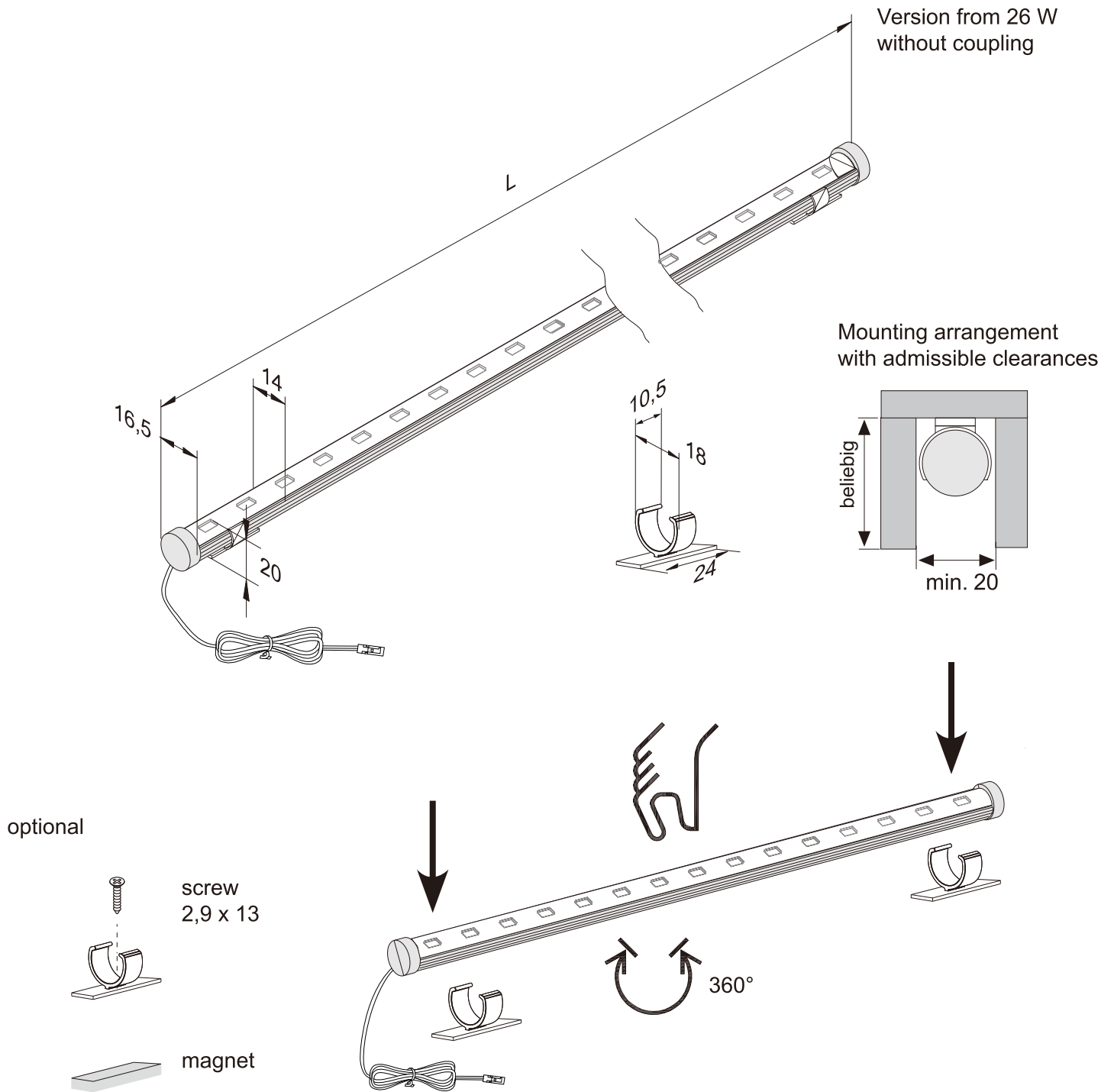

【Radiation Diagram】

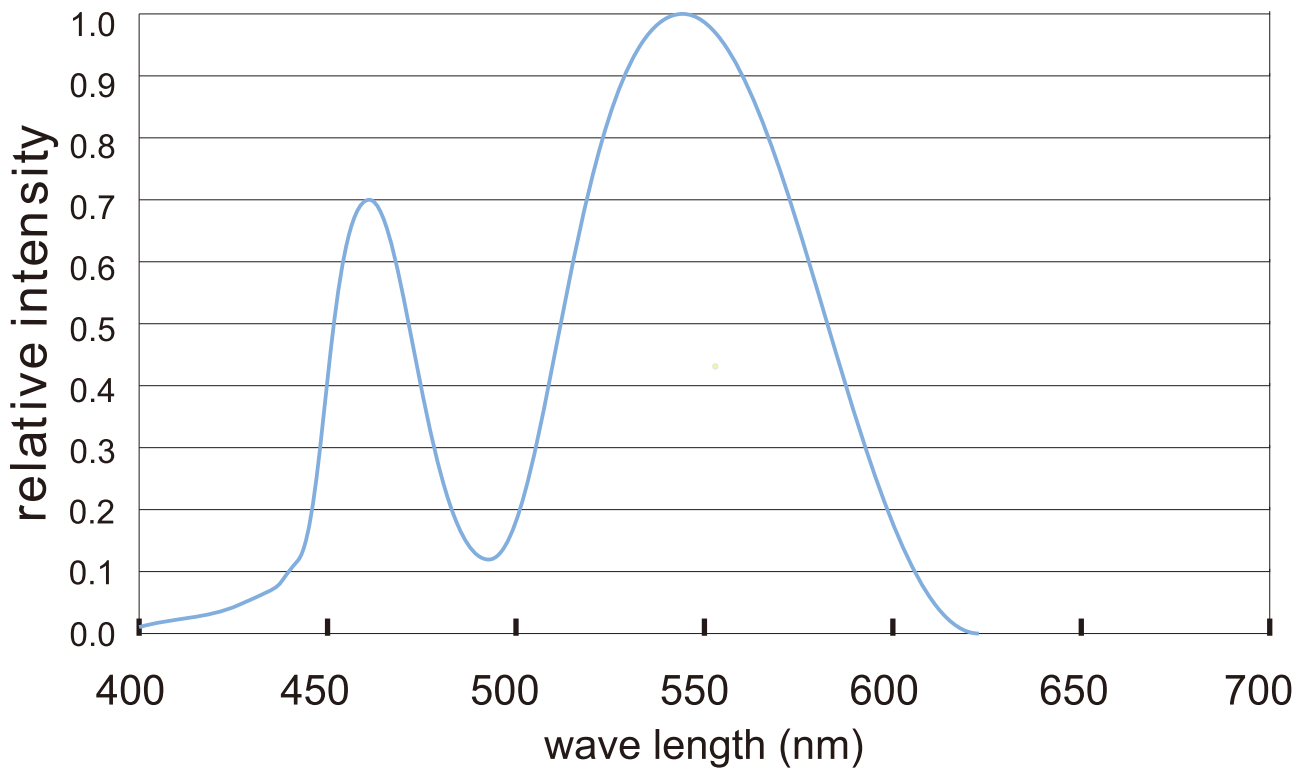
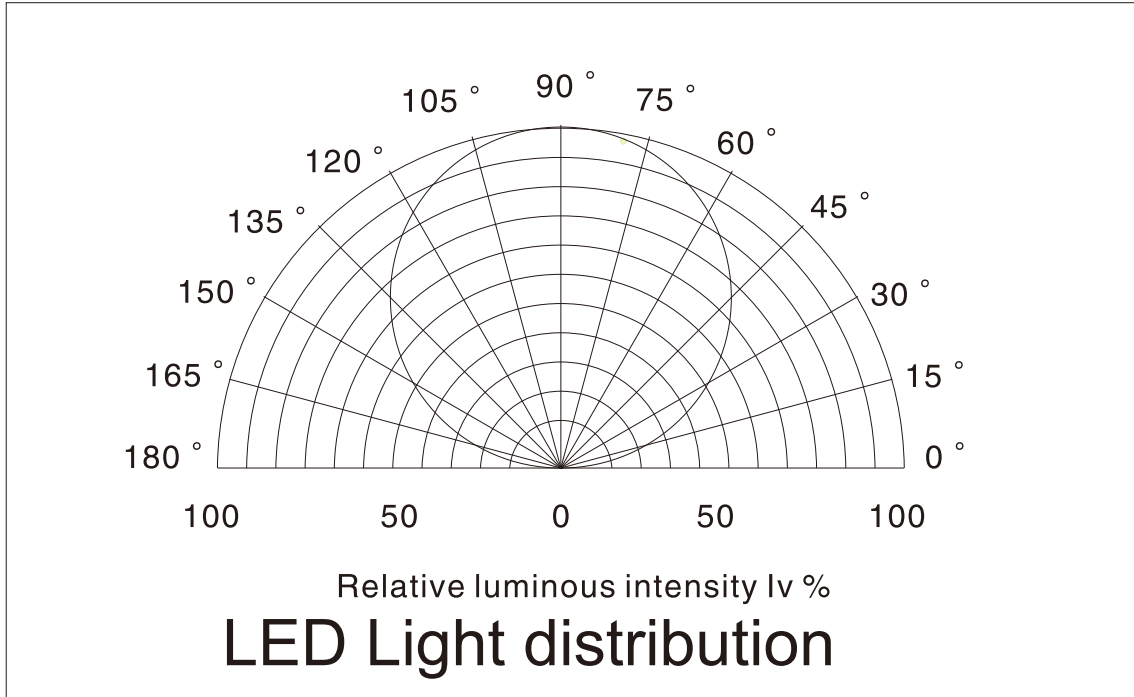

[installation procedure-01]

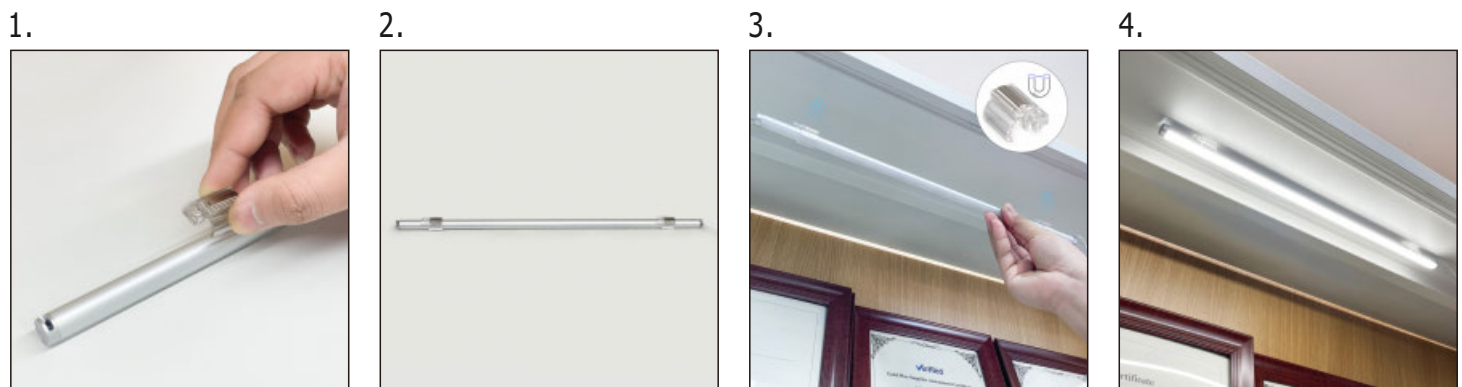

[installation procedure-02]

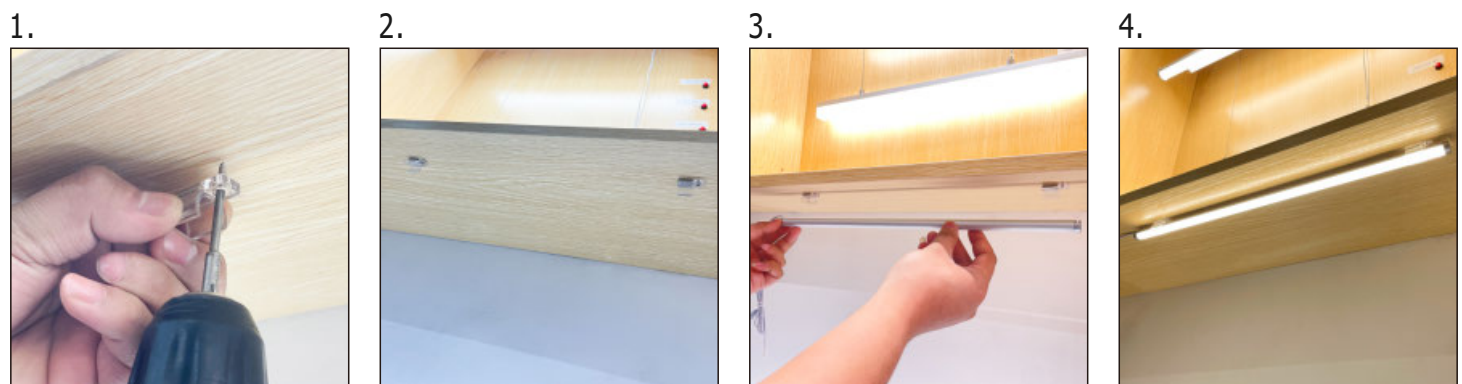

[Packing]



1PC in transparent PE bag

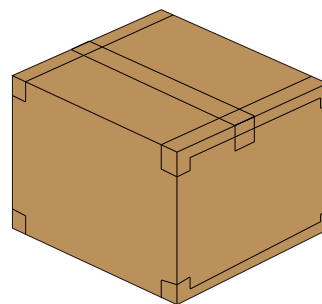

50PCS/CARTON