

ITR001

Features:

- The track is work with 12-24V power supply (customizable), which is convenient for installation and can be connected to the power supply after plugging in.
- According to the needs of different occasions, the space layout can be controlled arbitrarily, The metal panels.
- Max weight to hold up to 30 kg.



Accessories:

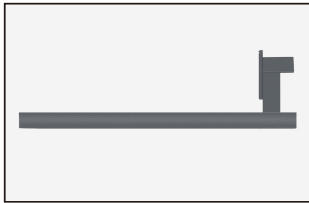

ITR001-POST
(1500/2000mm)



ITR001-HT(Max 8A)

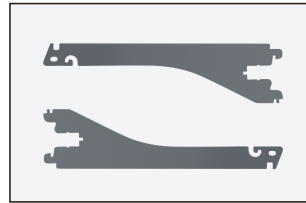

ITR001-BR
(Length 300mm)

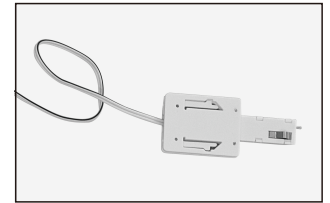

ITR001-HP(Max 2A)
Cable length 35mm.

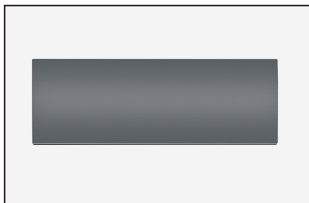

ITR001-BAP

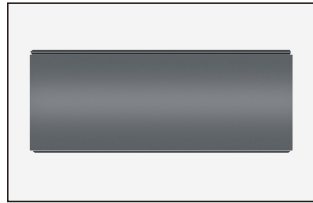

ITR001-SF
(Width 300mm
Length 900/1200mm)

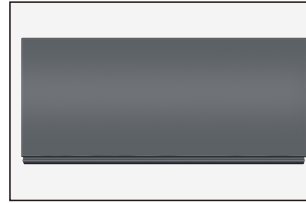

ITR001-BTP
(Width 350mm
Length 900/1200mm)

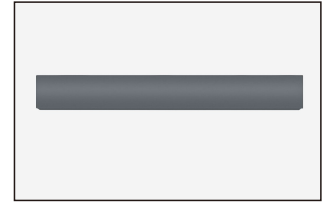

ITR001-FAP
(Length 900/1200mm)

Size:

ITR001-POST

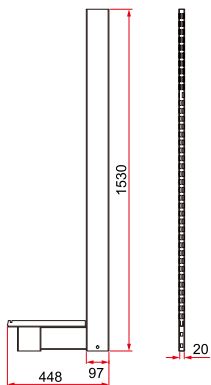

ITR001-HT

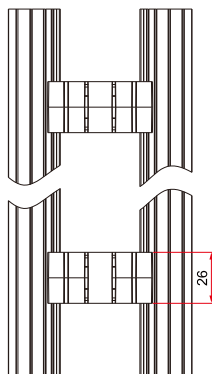

ITR001-HT

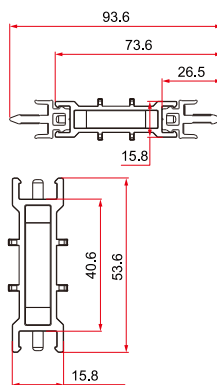
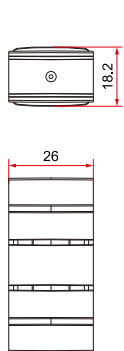

ITR001-HT

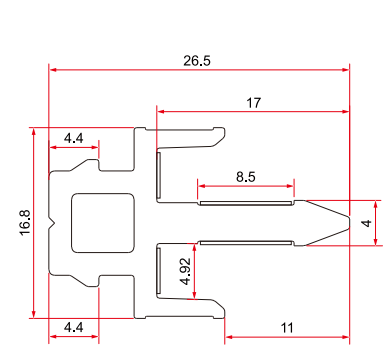

Size:

ITR001

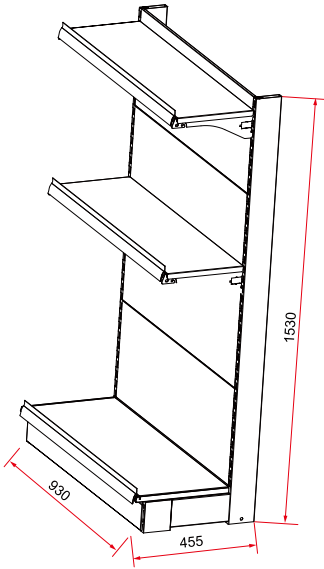

IITR001-BR

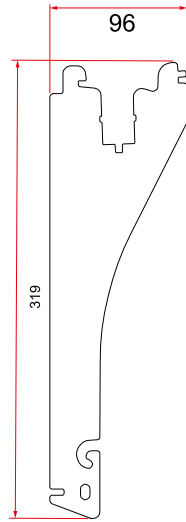

ITR001-HP

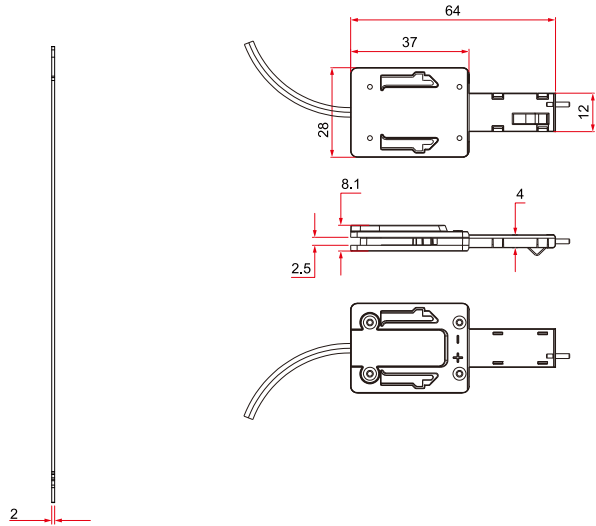

ITR001-BAP

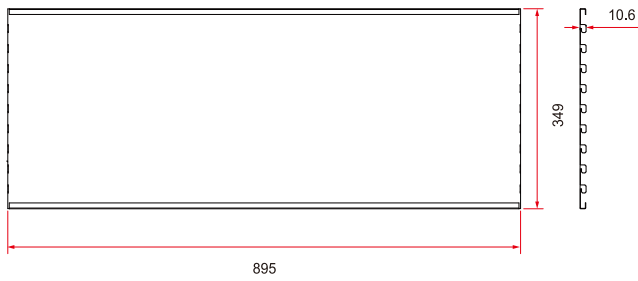

ITR001-SF

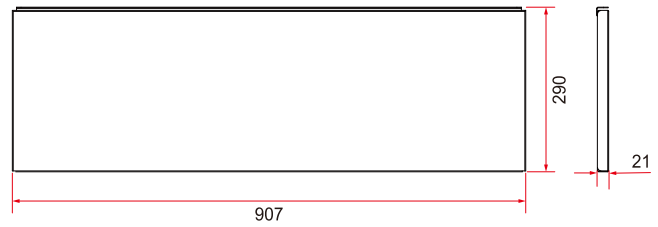

ITR001-BTP

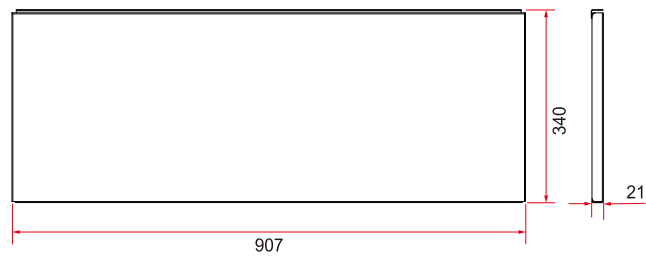

ITR001-FAP

