

Flex Led Neon Light

# N1220D

# FC-N1220D

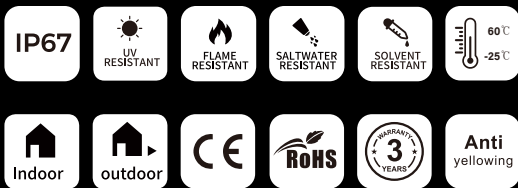

## Product Specification

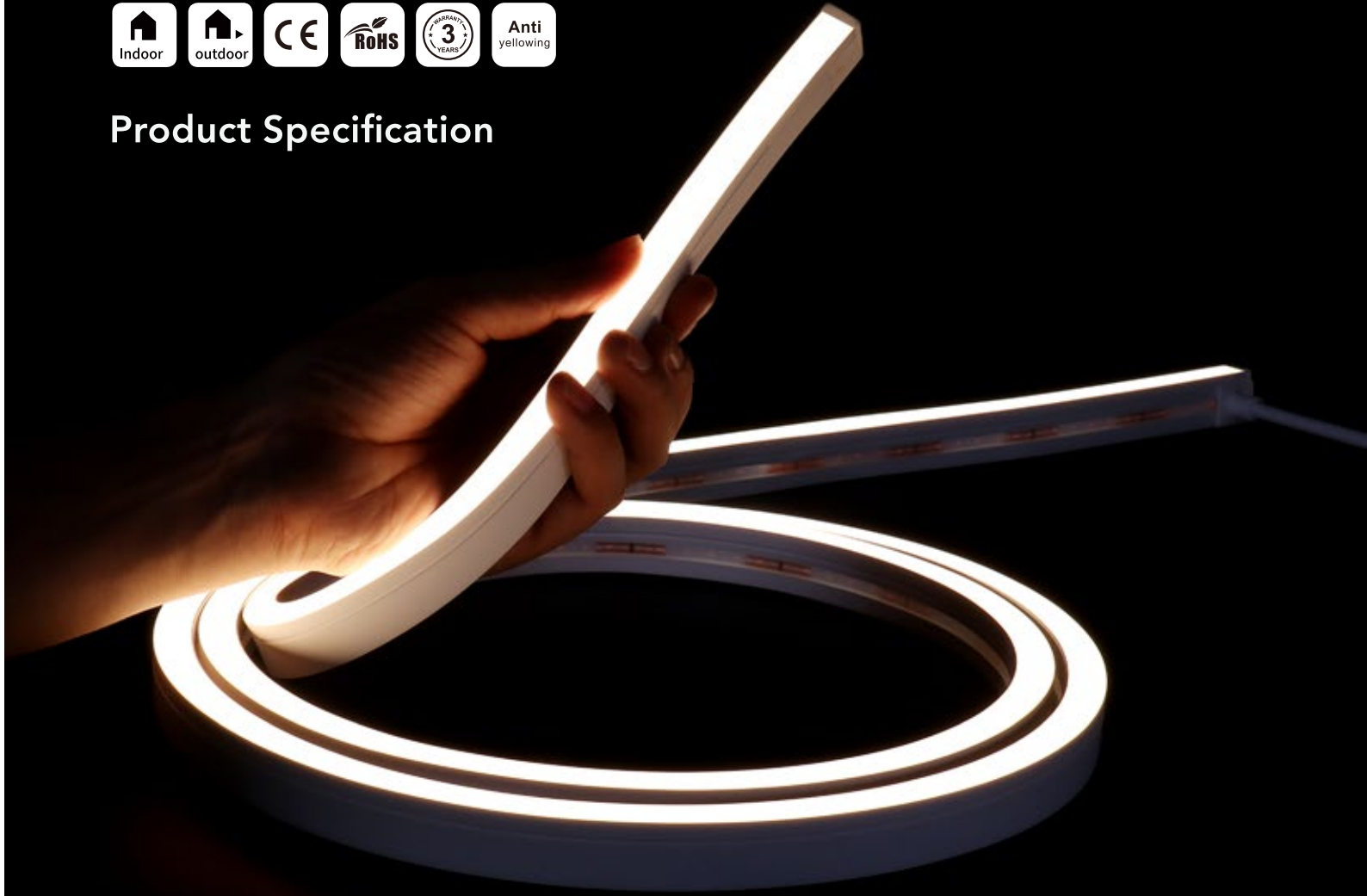

## LED strip colloid specifications comparison

Materials	Silicone flexible led strip	PVC flexible led strip	Notes
Main parameters			
Colloid features in -40°C	No crack after 30 days	Totally cracked	The low temperature resistant of silicone is superior than PVC or epoxy materials
Colloid features in 120°C	No obvious change after 72 hours	Colloid changed into yellow and deformed after 2 hours	The high temperature resistant of silicone is superior than PVC or epoxy
Colloid features in 180°C	No obvious change after 72 hours	Colloid changed into brown and some melted after 20 minutes	Over 150°C, PVC is easily hydrolyzed, Viscosity becomes weaken and easily seperated
Steadily lighted in Seawater for 72 hours	No obvious change	Serious atomization on the surface	The waterproof grade of silicone led strip can reach to IP67, high resistance to acidic alkali and salt properties
Thermal conductivity	Good thermal conductivity	No thermal conductivity	Pvc and epoxy cannot conduct heat, while silicone has good thermal conductivity

## Product features

- Anti-yellowing and heat resisting silicone glue, chemical resistance acid and alkaline, available for extremely terrible outdoor environment.
- Uniform and soft luminance, no light spot.
- Super brightness large chip, golden wire welded and copper led holder for quicker heat dissipation, higher stability, longer life span.
- Leadless SMT technique (RoHS certificated), smooth welding joint, firm connection of led and pcb.



# Specification



## Bending (Silicone)

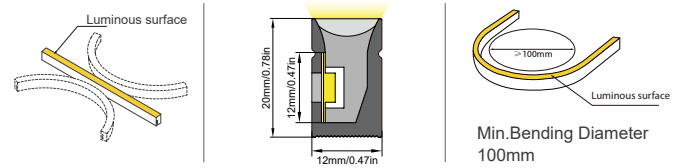

IP67 Protection	Flame Resistant	UV Resistant	Solvents Resistant	Saltwater Resistant
Dirt Resistant	CRI90	3 Years Warranty	Ambient Working 60°C -25°C	Anti yellowing

Model Number	N1220D	Size (mm)	12*20
PCB Limited (mm)	12mm	IP Grade	IP67
Working Temperature	-25 to 60°C	N.W.(G/M)	310g

## Dimensions of light

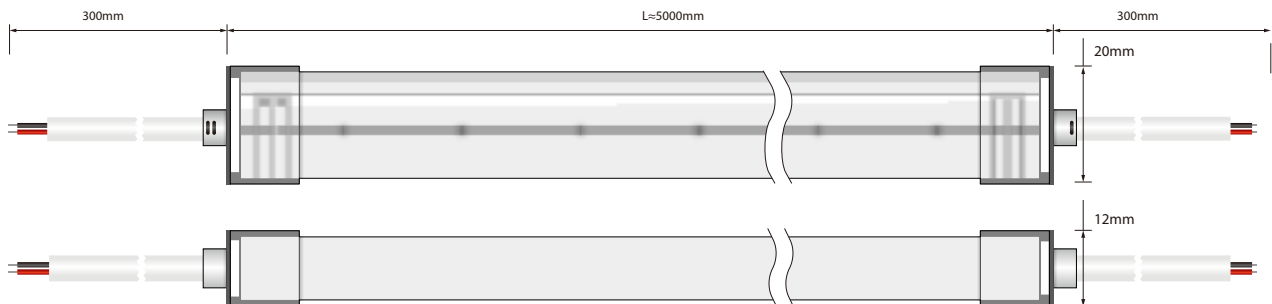

## VARIOUS CONNECTIONS

### Injection molded endcap.



front cable entry



side cable entry



bottom entry



closed

### Silicone glue endcap



front cable entry



side cable entry



bottom entry



closed

# VARIOUS CONNECTIONS

## Field install endcap





front cable entry



closed

## Recommend LED strip parameters



### (1) N1220D WHT

SMD2835, 120 LED/meter								
Part number	Color	Luneh/M	Unit cut	Cut every (LEDS)	LED Qty/M	Voltage	Power/M	Max run length
SUR-2835FW120-24V	WW 	611	50mm	6	120	24V	14.4W	5 meters from one end
	NW 	645						
	CW 	634						







### (2) N1220D TW

SMD3527, 120LED/meter, Dual color.								
Part number	Color	Luneh/M	Unit cut	Cut every (LEDS)	LED Qty/M	Voltage	Power/M	Max run length
SUR-3527FW120-24V	WW 	268	50mm	6	120	24V	7.2W	5 meters from one end
	CW 	274						



### (3) N1220D RGB

3838RGB LED Strip, 120 LED/Meter								
Part number	Color	Luneh/M	Unit cut	Cut every (LEDS)	LED Qty/M	Voltage	Power/M	Max run length
SUR-3528RGB-120-24V	Red 	52	50mm	6	120	24V	4.8W	5 meters from one end
	Green 	154						
	Blue 	33						



### (4) N1220D RGBW

5050RGBW, 96 LED/Meter								
Part number	Color	Luneh/M	Unit cut	Cut every (LEDS)	LED Qty/M	Voltage	Power/M	Max run length
SUR-5050RGBW-96-24V	Red 	42	62.5mm	6	96	24V	3.75W	5 meters from one end
	Green 	117						
	Blue 	23						
	WW 	119						
	NW 	125						
	CW 	123						

(5) N1220D SPIRGB

5050RGBIC, 84 LED/Meter								
Part number	Color	Luneh/M	Unit cut	Cut every (LEDS)	LED Qty/M	Voltage	Power/M	Max run length
SUR-5050RGBIC-84-24V	Red 	54	71.43mm	6	84	24V	5W	5 meters from one end
	Green 	160						
	Blue 	34						

(6) FC-N1220D WHT

SMD2835, 180LED/meter								
Part number	Color	Luneh/M	Unit cut	Cut every (LEDS)	LED Qty/M	Voltage	Power/M	Max run length
SUR-2835FW180-24V	WW 	651	cut anywhere	1	180	24V	14.4W	5 meters from one end
	NW 	685						
	CW 	674						

**N1220D-Accessories**

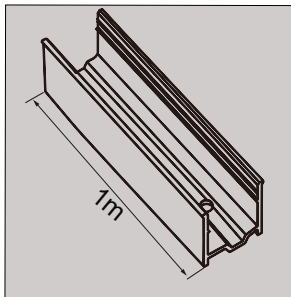

LED profile:  
1m/pc

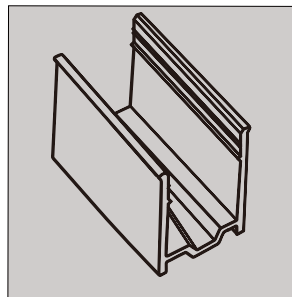

Mounting clip  
(Optional)

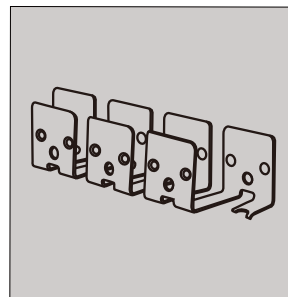

Curved profile  
1m/pc

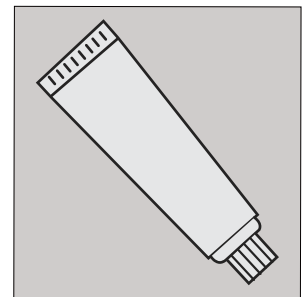

Glue

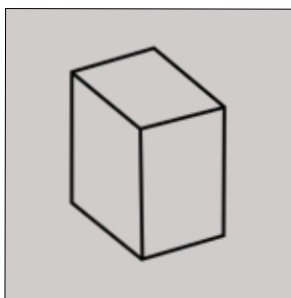

Closed silicone  
endcap

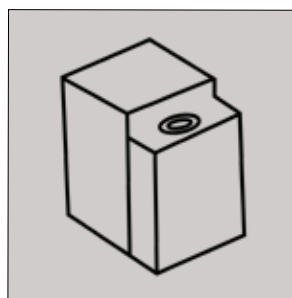

Silicone endcap  
-bottom

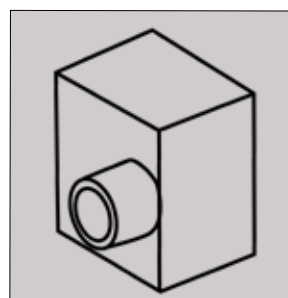

Silicone endcap  
-side

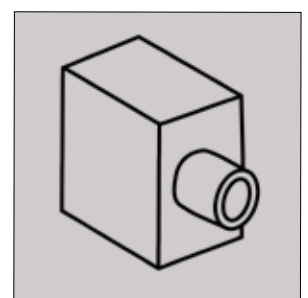

Silicone endcap  
-front

## Cable

Cable Type	Schematic Diagram	Specification	Core	Electrical Properties
PVC Cable		OD: 4.0mm /Inner core: 20AW/G	●●	Red V+,Black V-
		OD: 4.5mm /Inner core: 20AW/G	●●○	Black V+,White W,Yellow WW
		OD: 4.5mm /Inner core: 20AW/G	●●●●	Red V+,Blue&Black GND,Green DATA
		OD: 4.5mm /Inner core: 20AW/G	●●●●	Black V+,Blue B,Green G,Red R
		OD: 6.0mm /Inner core: 20AW/G	●○●●●	Black V+,White W,Blue B,Green G,Red R

Cable Type	Schematic Diagram	Specification	Core	Electrical Properties
Silicone Cable		OD: 6.0mm /Inner core: 18AW/G	●●	Red V+,Black V-
		OD: 6.0mm /Inner core: 20AW/G	●●○	Black V+,White W,Yellow WW
		OD: 4.5mm /Inner core: 20AW/G	●●●●	Red V+,Blue&Black GND,Green DATA
		OD: 6.0mm /Inner core: 20AW/G	●●●●	Black V+,Blue B,Green G,Red R
		OD: 6.6mm /Inner core: 20AW/G	●○●●●	Black V+,White W,Blue B,Green G,Red R

**Note: For more accessories, please contact our sales.**

## Driver & Cotronller



Order code: XLG-150-24-A  
AC100-305V DC24V 150W  
IP67, Global certification.  
Non Dimmable.



Order code: ELG-150-24B  
AC100-305V DC24V 150W  
IP67, Global certification  
3in1 dimming function: 0-10Vdc,  
10V PWM signal and resistance.



Order code: ELG-150-24DA  
AC100-305V DC24V 150W  
IP67, Global certification  
Dali control technology.

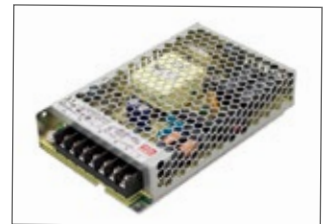

Order code: ELG-150-24DA  
AC100-305V DC24V 150W  
IP67, Global certification  
Dali control technology.



SD Card programe controller. SMD  
Capacity supports 128MB-32GB



For RGB IC- SP105E Magic controller  
\*For more info please contact our  
sales



RGB+W controller: 4 Channel  
DC12V/24V, 6A, RGB+W, RF remote  
with finger touch ring.



RGB Controller: 3 Channel  
DC12V/24V, 6A RGB controller, RF  
remote with finger touch ring. .



Dimmer:1 Channel DC12V/24V, 6A,  
Dimmer, RF remote with finger touch  
ring.



CCT Adjustable- 2 Channel  
DC12V/24V,6A, CCT adjustable, RF  
remote with finger touch ring.

# Product system solutions

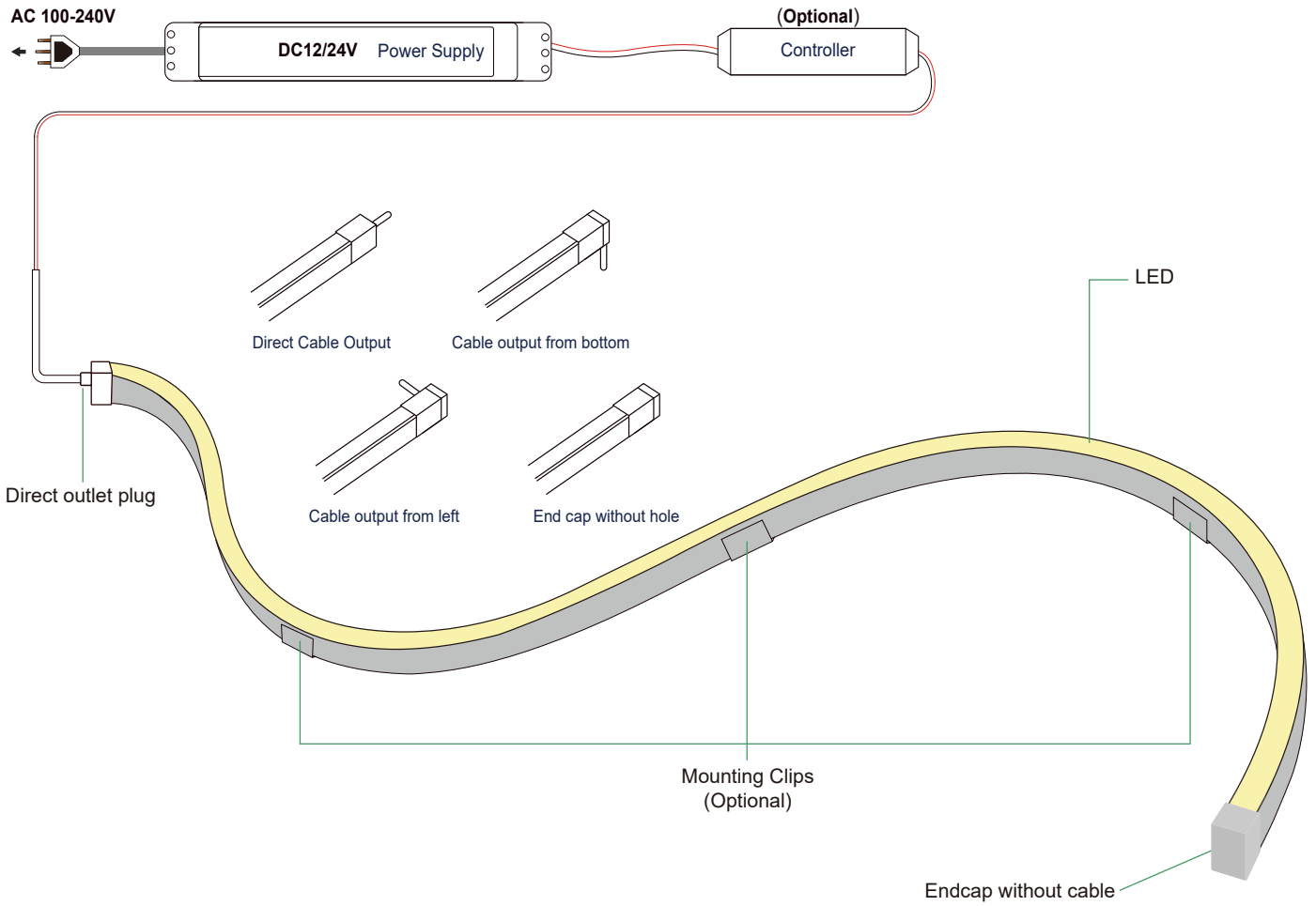

## Cut mark



Remarks: There is a transparent window at the bottom of the light strip,



Make precise vertical cuts at the exact cut position of the light strip.

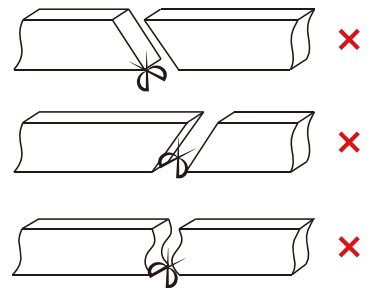

Please do not arbitrarily cut or cut into a bevel and arc section.

## Installation

This product is suitable for surface mounting or embedded sealing installation. Recommended slot size: Width 12mm, Depth 20mm, gently press the neon sleeve into the slot.

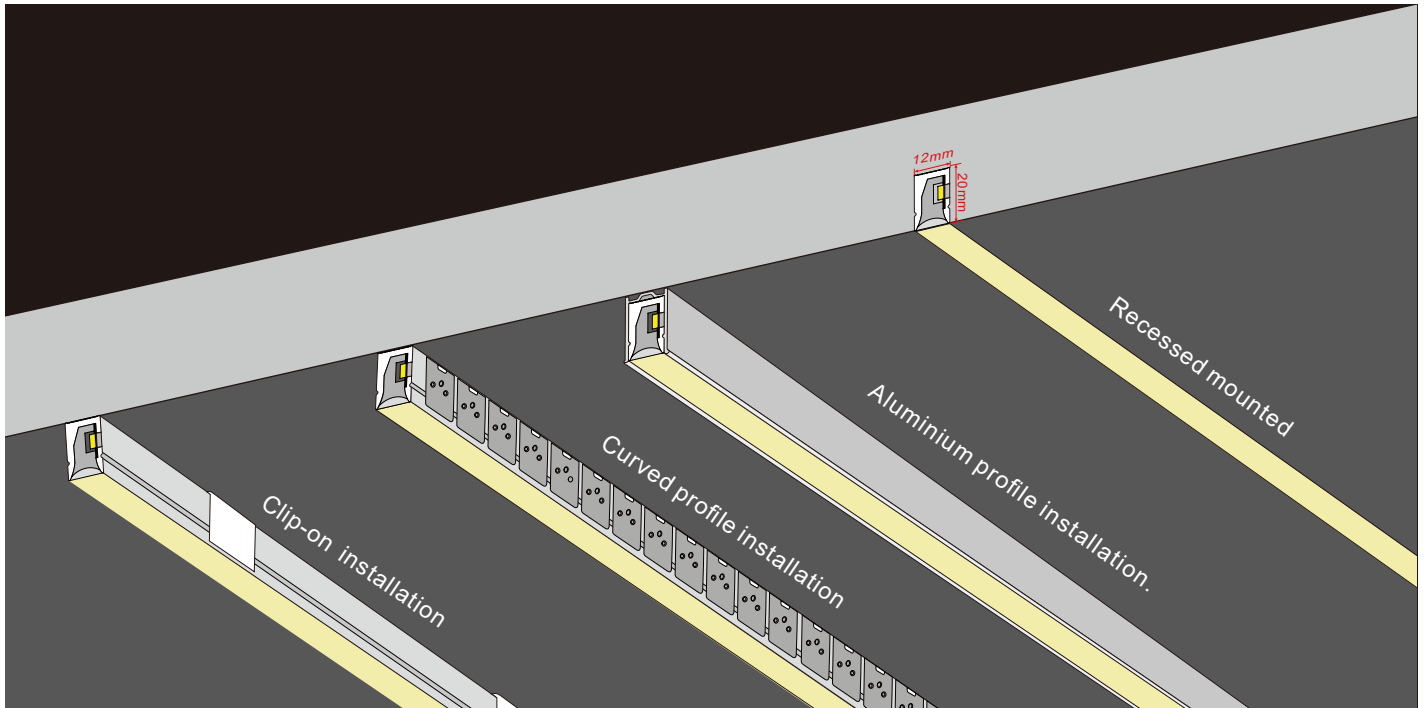

## Installation of carrier

1. When installing the LED strip, install it from both ends at the same time, installation from one direction is prohibited.

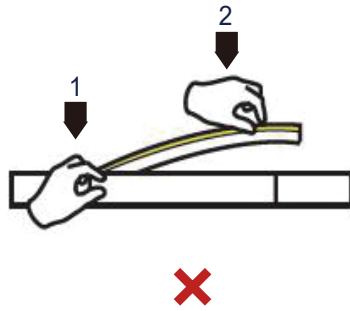
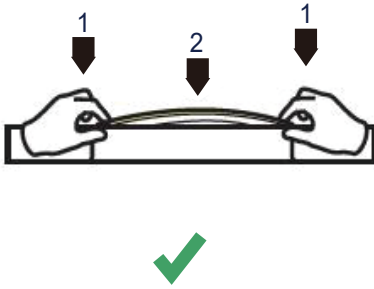

⚠ If the length of LED strip is over 2m, it is recommended to install by two persons.

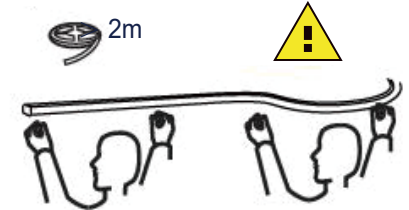

2. Use tool to disassemble carefully, and do not pull the LED strip directly.

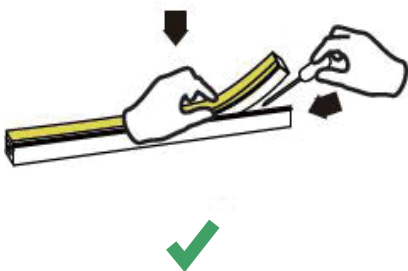

⚠ If the length of LED strip is over 2m, it is recommended to disassemble by two persons.

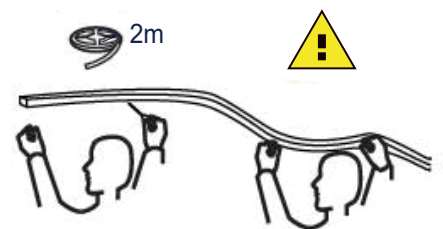



## Cautions

- Please notice that the strips are not bendable to all directions. As the appropriate specific shape and degree, please follow the following instruction.
- LED strips are low voltage products, you must use the power supply (transformer). Please don't connect the led strip directly to the AC 110V or AC 220V. Otherwise, it will burn out the LED strips and lead to safety (security) accidents.
- Please read the specifications thoroughly before installation by professional staff to make sure the safe use.

## Wrong bending way

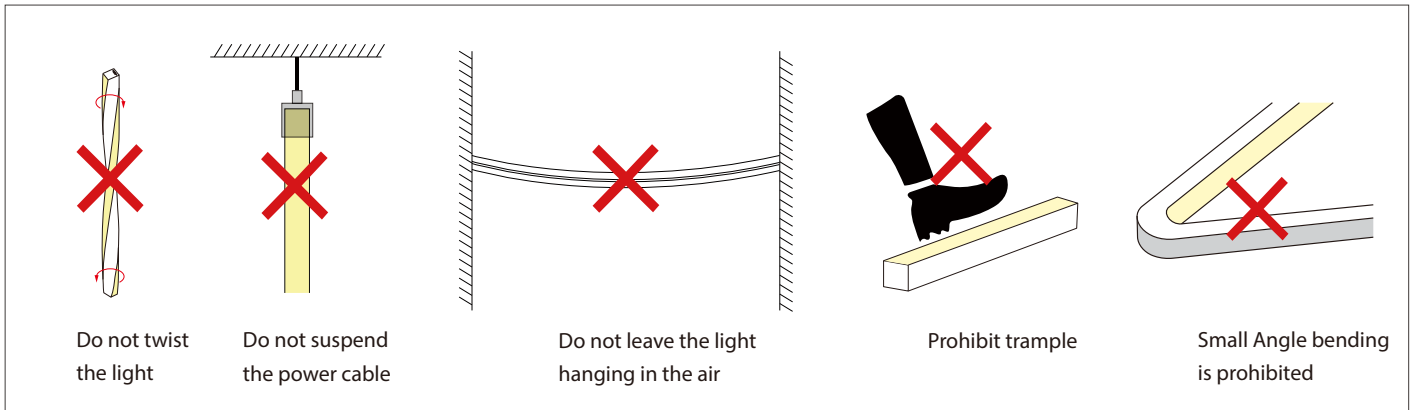

## Correct bending way

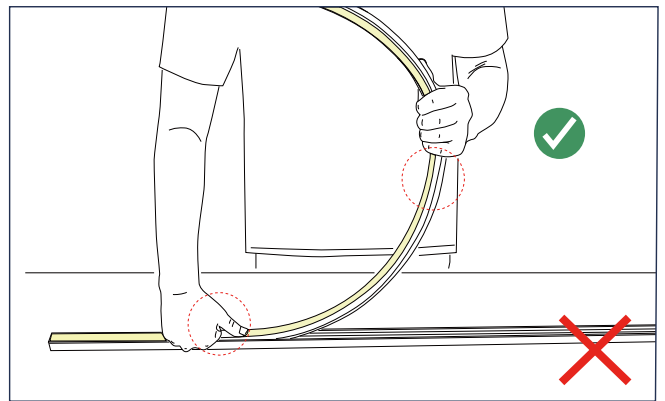
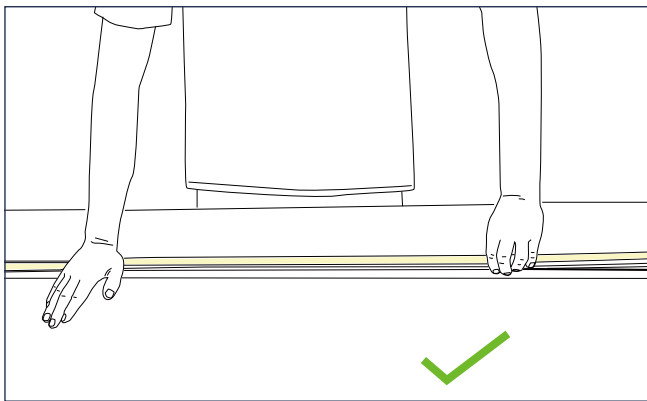

- Please press the led strip with your palm to slowly insert the led strip into the groove, and gently straighten the led strip above the groove with your right hand.
- Try to keep the led strip in a flat state during the installation process.

- Do not press the led strip with a single finger, it is easy to damage the internal parts of the led strip.
- The bent arc of the led strip should not be too large during installation.

## Installation Precautions -- Side Mounted

( If the length of the light is more than 2 meters, two persons must work together to install it. )

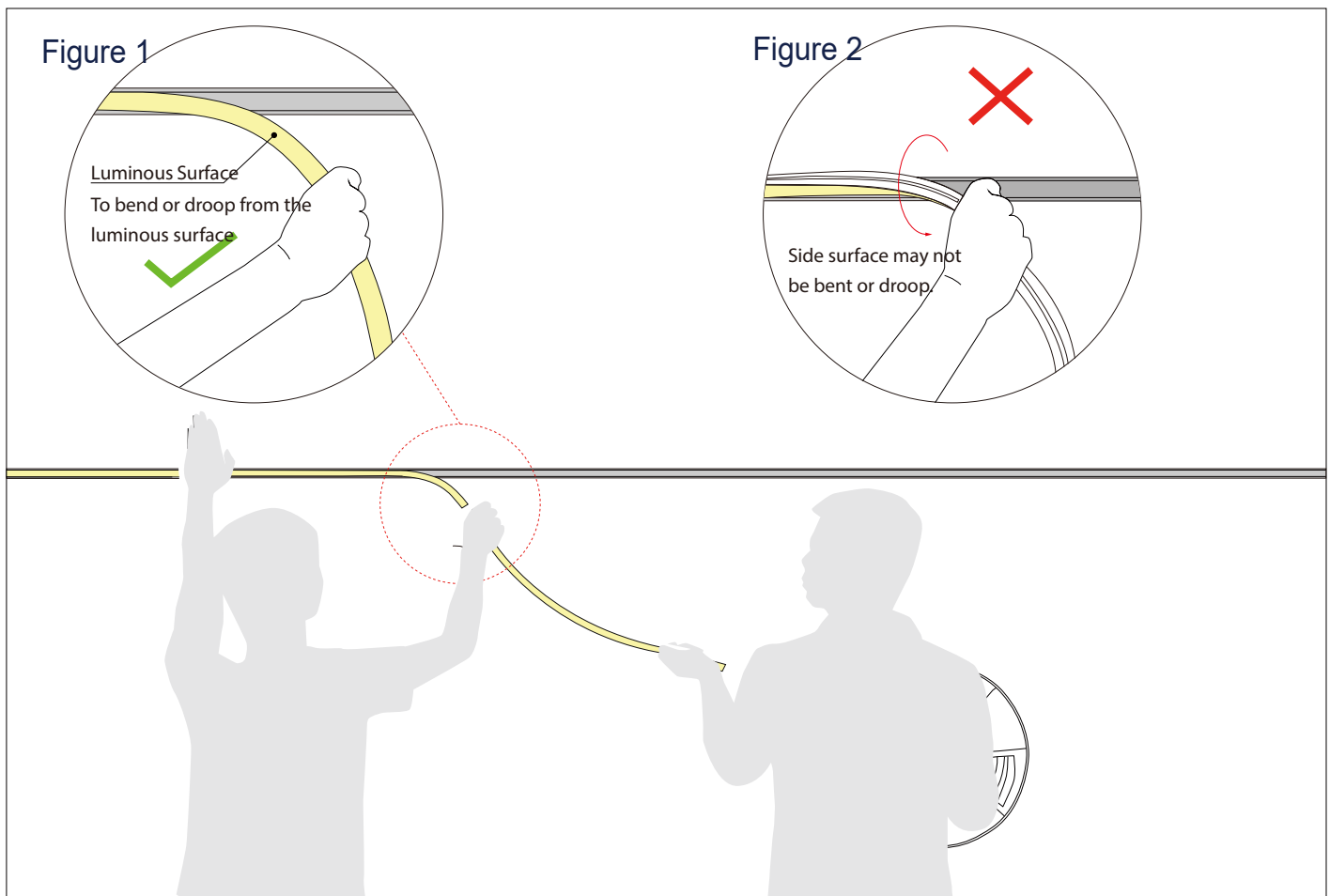

### 1. Installer:

- Press the light with the palm of the left hand to slowly load it into the slot. Straighten the light with right hand so that it droop it in the direction of your hand. See Figure 1.
- Side surface may not be bent or droop, See Figure 2.

### 2. Assistant:

- Cooperate with the installer to lift the reel of the light, and then slowly deliver the light to installer. Do not pull or twist the light during the installation.

## Package of neon strip (5M/Roll)

