

Flex Led Neon Light

N0410D FC-N0410D

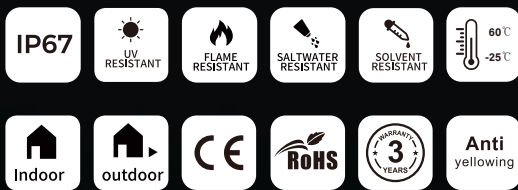

Product Specification



LED strip colloid specifications comparison

Materials	Silicone flexible led strip	PVC flexible led strip	Notes
Main parameters			
Colloid features in -40°C	No crack after 30 days	Totally cracked	The low temperature resistant of silicone is superior than PVC or epoxy materials
Colloid features in 120°C	No obvious change after 72 hours	Colloid changed into yellow and deformed after 2 hours	The high temperature resistant of silicone is superior than PVC or epoxy
Colloid features in 180°C	No obvious change after 72 hours	Colloid changed into brown and some melted after 20 minutes	Over 150°C, PVC is easily hydrolyzed, Viscosity becomes weaken and easily seperated
Steadily lighted in Seawater for 72 hours	No obvious change	Serious atomization on the surface	The waterproof grade of silicone led strip can reach to IP67, high resistance to acidic alkali and salt properties
Thermal conductivity	Good thermal conductivity	No thermal conductivity	Pvc and epoxy cannot conduct heat, while silicone has good thermal conductivity

Product features

- Anti-yellowing and heat resisting silicone glue, chemical resistance acid and alkaline, available for extremely terrible outdoor environment.
- Uniform and soft luminance, no light spot.
- Super brightness large chip, golden wire welded and copper led holder for quicker heat dissipation, higher stability, longer life span.
- Leadless SMT technique (RoHS certificated), smooth welding joint, firm connection of led and pcb.



Specification

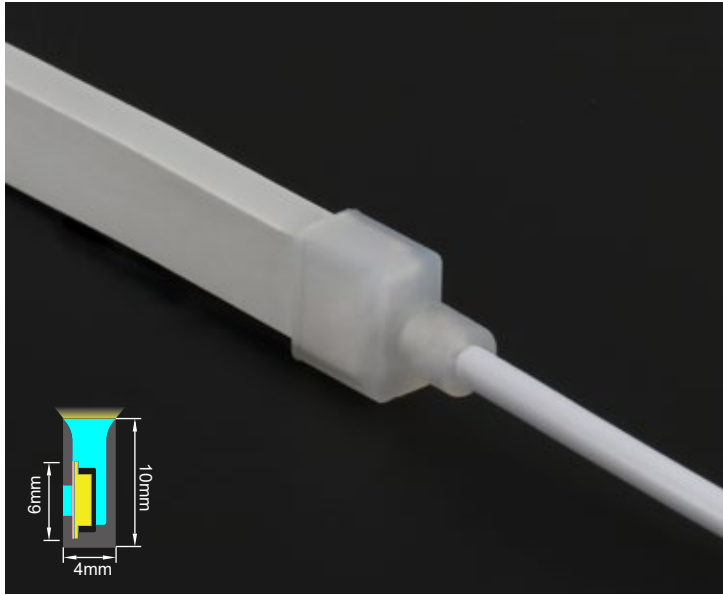

Bending (Silicone)

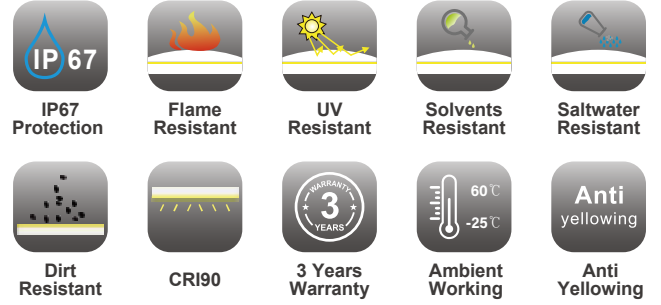
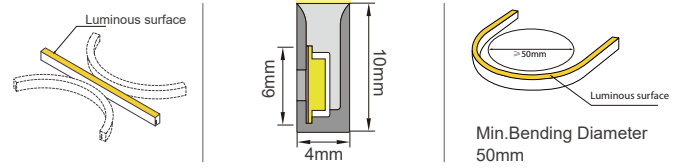

Model Number	N0410D	Size (mm)	4*10
PCB Limited (mm)	6mm	IP Grade	IP67
Working Temperature	-25 to 60°C	N.W.(G/M)	25g

Dimensions of light

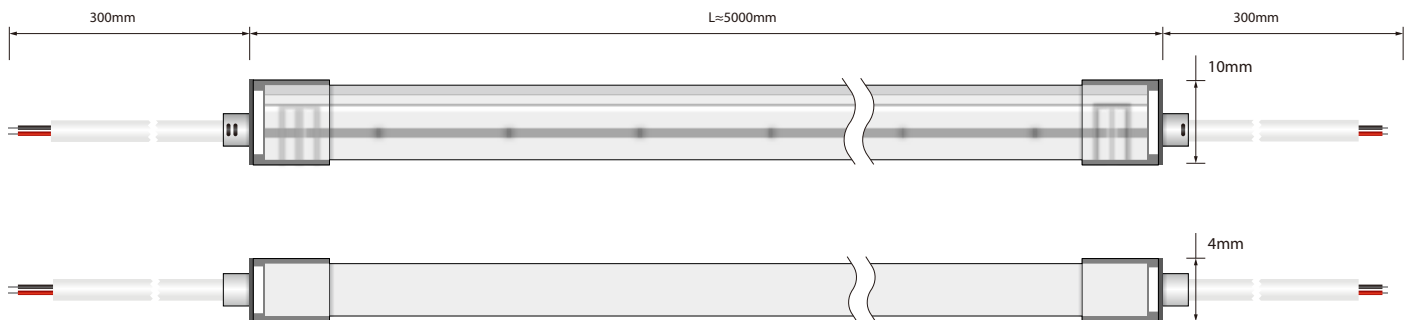

VARIOUS CONNECTIONS

Silicone glue endcap





front cable entry





closed

Recommend LED strip parameters

(1) N0410D WHT

SMD2835, 168 LED/meter								
Part number	Color	Luneh/M	Unit cut	Cut every (LEDS)	LED Qty/M	Voltage	Power/M	Max run length
SUR-2835FW168-24V	WW 	276	41.67mm	7	168	24V	9.6W	5 meters from one end
	NW 	292						
	CW 	287						

(2) FC-N0410D WHT

SMD2835, 180LED/meter								
Part number	Color	Luneh/M	Unit cut	Cut every (LEDS)	LED Qty/M	Voltage	Power/M	Max run length
SUR-2835FW180-24V	WW 	250	cut anywhere	1	180	24V	9.6W	5 meters from one end
	NW 	263						
	CW 	258						

N0410D-Accessories

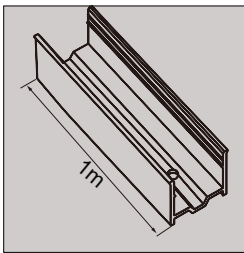

LED profile:
1m/pc

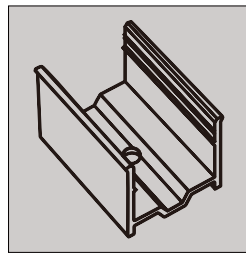

Mounting clip
(Optional)

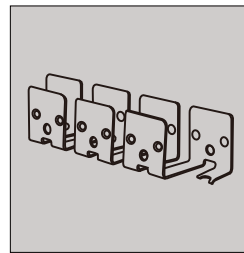

Curved profile
1m/pc

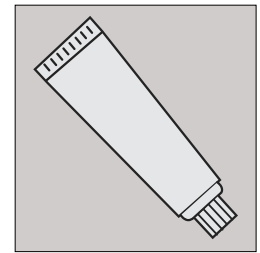

Glue

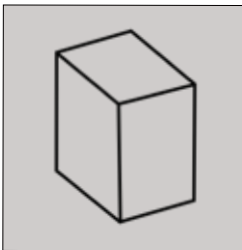

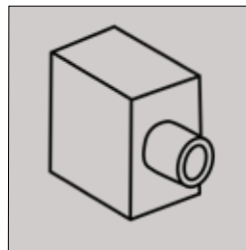

Closed silicone
endcap



Silicone endcap
-front

Cable

Cable Type	Schematic Diagram	Specification	Core	Electrical Properties
PVC Cable		OD: 4.0mm /Inner core: 20AWG		Red V+,Black V-

Note: For more accessories, please contact our sales.

Driver & Cotronller



Order code: XLG-150-24-A
AC100-305V DC24V 150W
IP67, Global certification.
Non Dimmable.



Order code: ELG-150-24B
AC100-305V DC24V 150W
IP67, Global certification
3in1 dimming function: 0-10Vdc,
10V PWM signal and resistance.



Order code: ELG-150-24DA
AC100-305V DC24V 150W
IP67, Global certification
Dali control technology.

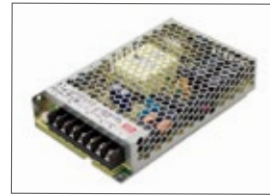

Order code: ELG-150-24DA
AC100-305V DC24V 150W
IP67, Global certification
Dali control technology.



DC12V/24V, 6A, Dimmer, RF remote with finger touch ring.
Use RF signal for telecontroller, free and easy operation, no direction in 20 meters; Wide options of over 640,000 colors, change according to your mood.
8 grades brightness adjusting, to achieve real energy-saving; With auto & manual color change mode. Long life, lifespan up to 40000hours; Low energy consumption; No UV radiation, no stroboflash

Product system solutions

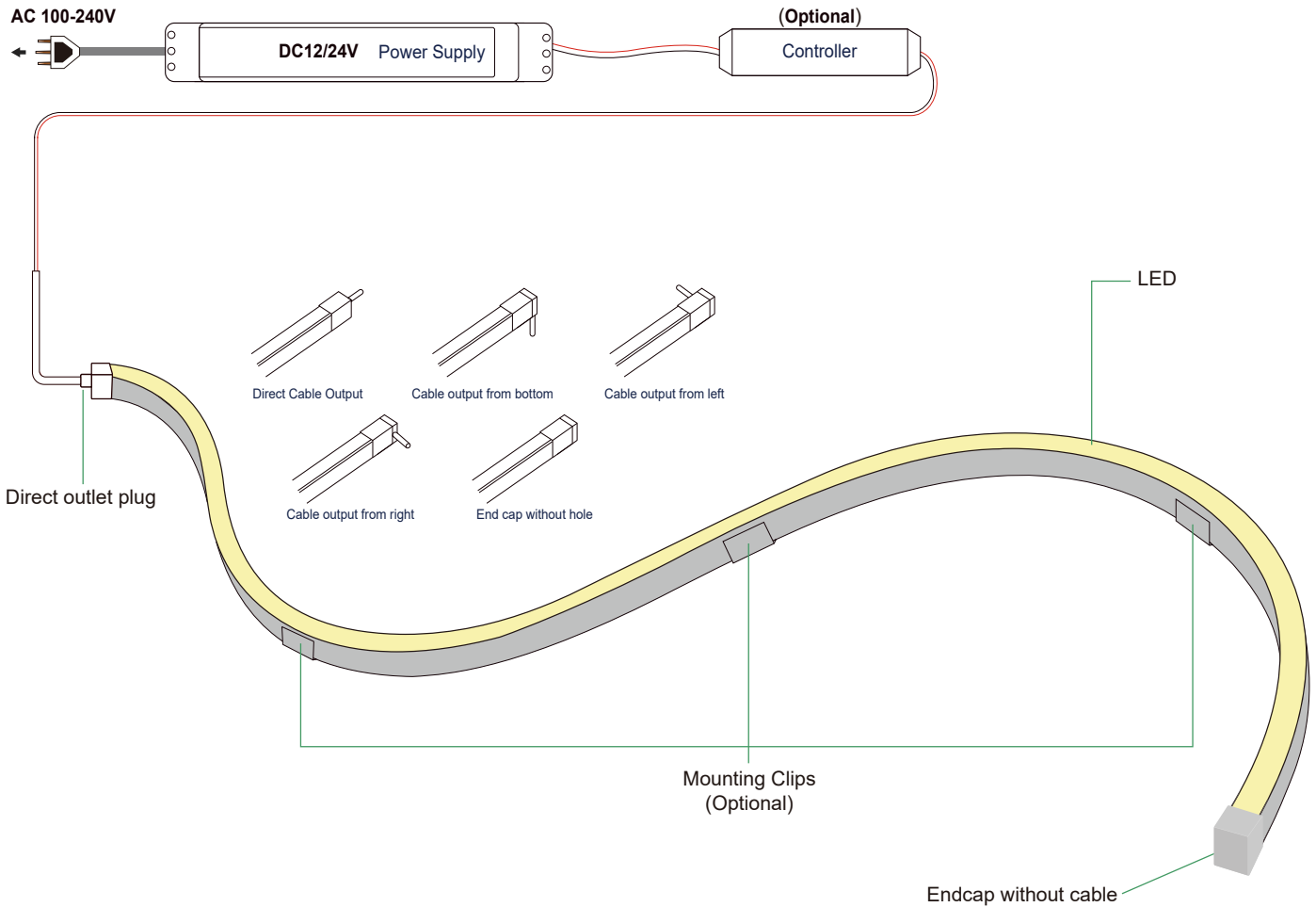

Cut mark

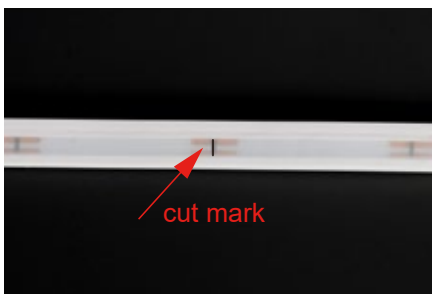

Remarks: There is a transparent window at the bottom of the light strip,



Make precise vertical cuts at the exact cut position of the light strip.

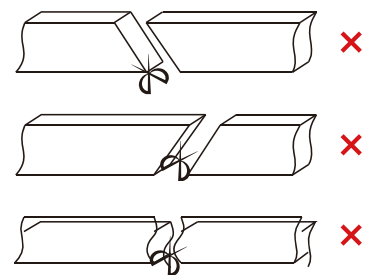

Please do not arbitrarily cut or cut into a bevel and arc section.

Installation

This product is suitable for surface mounting or embedded sealing installation. Recommended slot size: Width 04mm, Depth 10mm, gently press the neon sleeve into the slot.

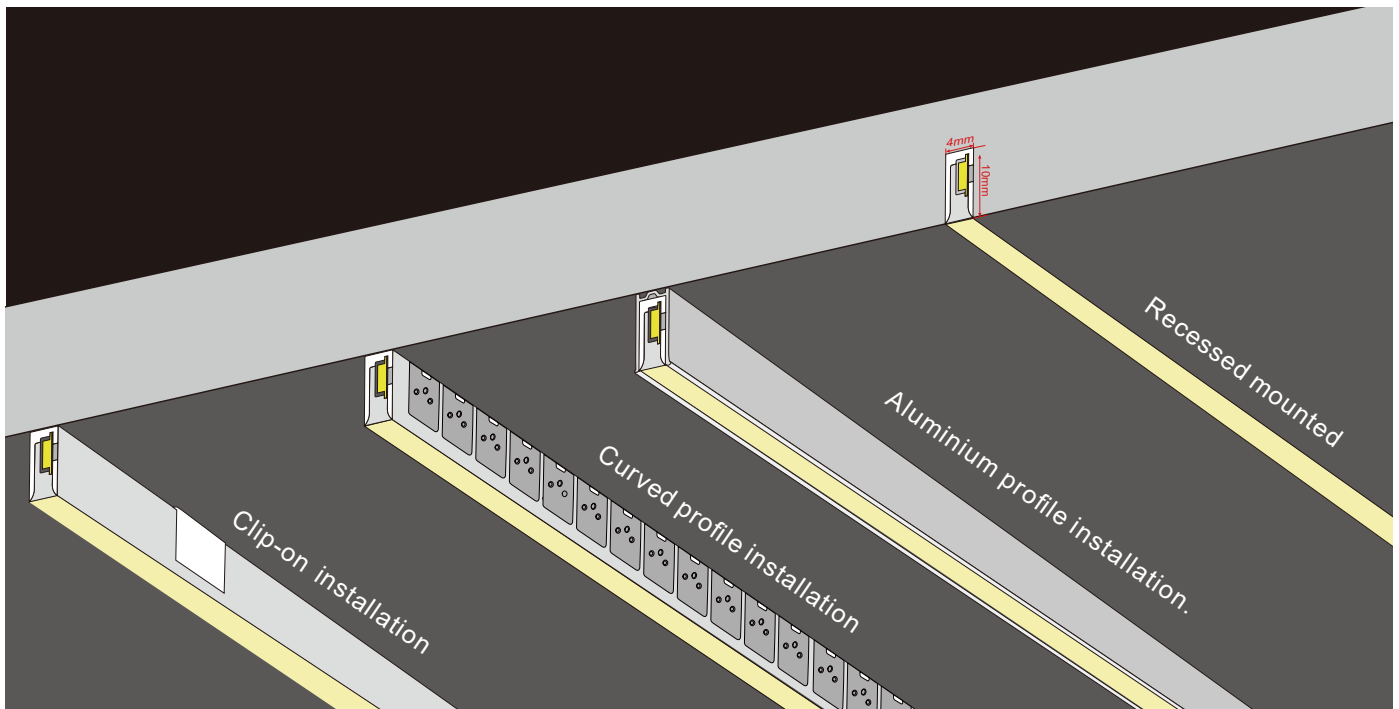

Installation of carrier

1. When installing the LED strip, install it from both ends at the same time, installation from one direction is prohibited.

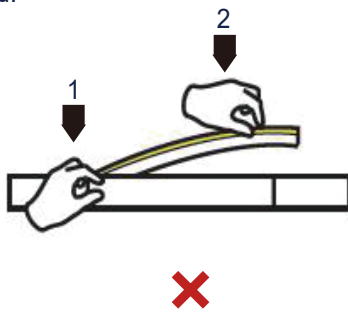
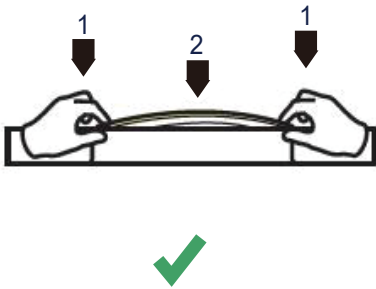

⚠ If the length of LED strip is over 2m, it is recommended to install by two persons.



2. Use tool to disassemble carefully, and do not pull the LED strip directly.

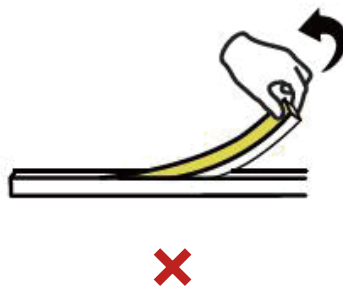
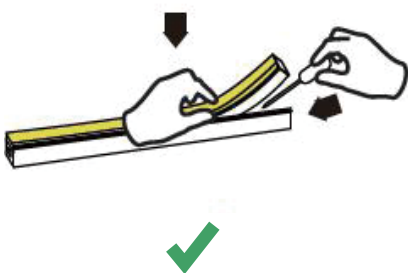

⚠ If the length of LED strip is over 2m, it is recommended to disassemble by two persons.

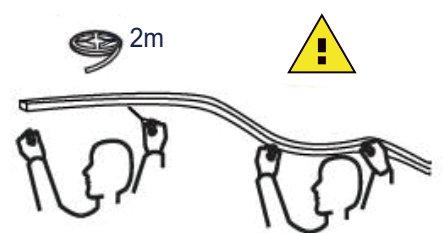

Cautions

- Please notice that the strips are not bendable to all directions. As the appropriate specific shape and degree, please follow the following instruction.
- LED strips are low voltage products, you must use the power supply (transformer). Please don't connect the led strip directly to the AC 110V or AC 220V. Otherwise, it will burn out the LED strips and lead to safety (security) accidents.
- Please read the specifications thoroughly before installation by professional staff to make sure the safe use.

Wrong bending way

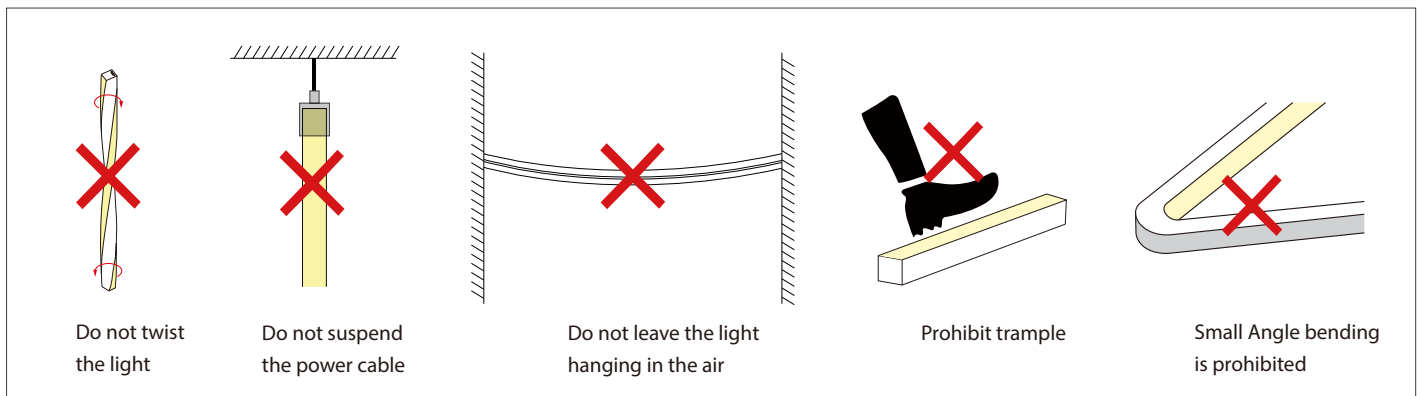

Correct bending way

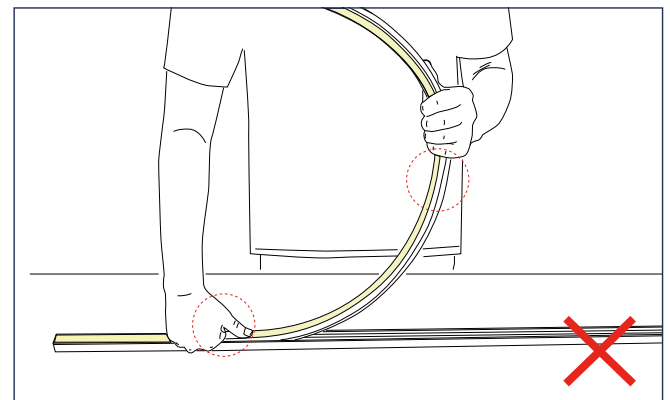
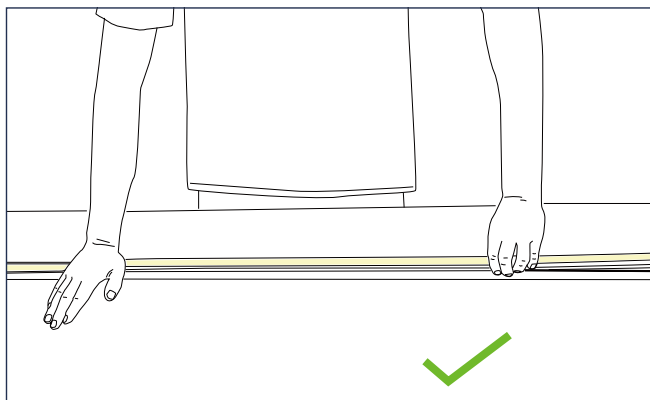

- Please press the led strip with your palm to slowly insert the led strip into the groove, and gently straighten the led strip above the groove with your right hand.
- Try to keep the led strip in a flat state during the installation process.

- Do not press the led strip with a single finger, it is easy to damage the internal parts of the led strip.
- The bent arc of the led strip should not be too large during installation.

Installation Precautions -- Side Mounted

(If the length of the light is more than 2 meters, two persons must work together to install it.)

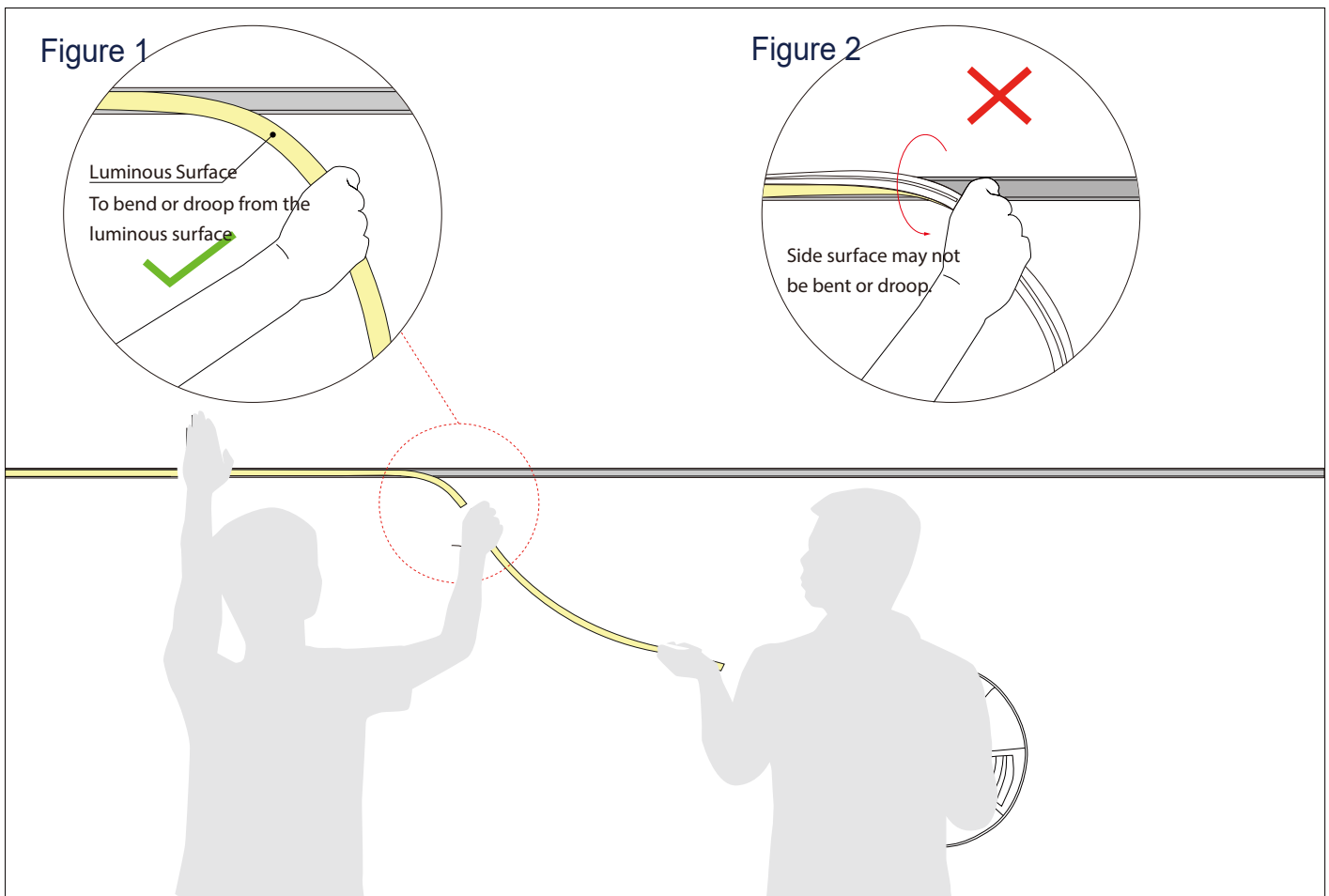

1. Installer:

- Press the light with the palm of the left hand to slowly load it into the slot. Straighten the light with right hand so that it droop in the direction of your hand. See Figure 1.
- Side surface may not be bent or droop, See Figure 2.

2. Assistant:

- Cooperate with the installer to lift the reel of the light, and then slowly deliver the light to installer. Do not pull or twist the light during the installation.

Package of neon strip (5M/Roll)

