

360° Silicone Extrusion Round Neon Tube

Model No.: ND24D

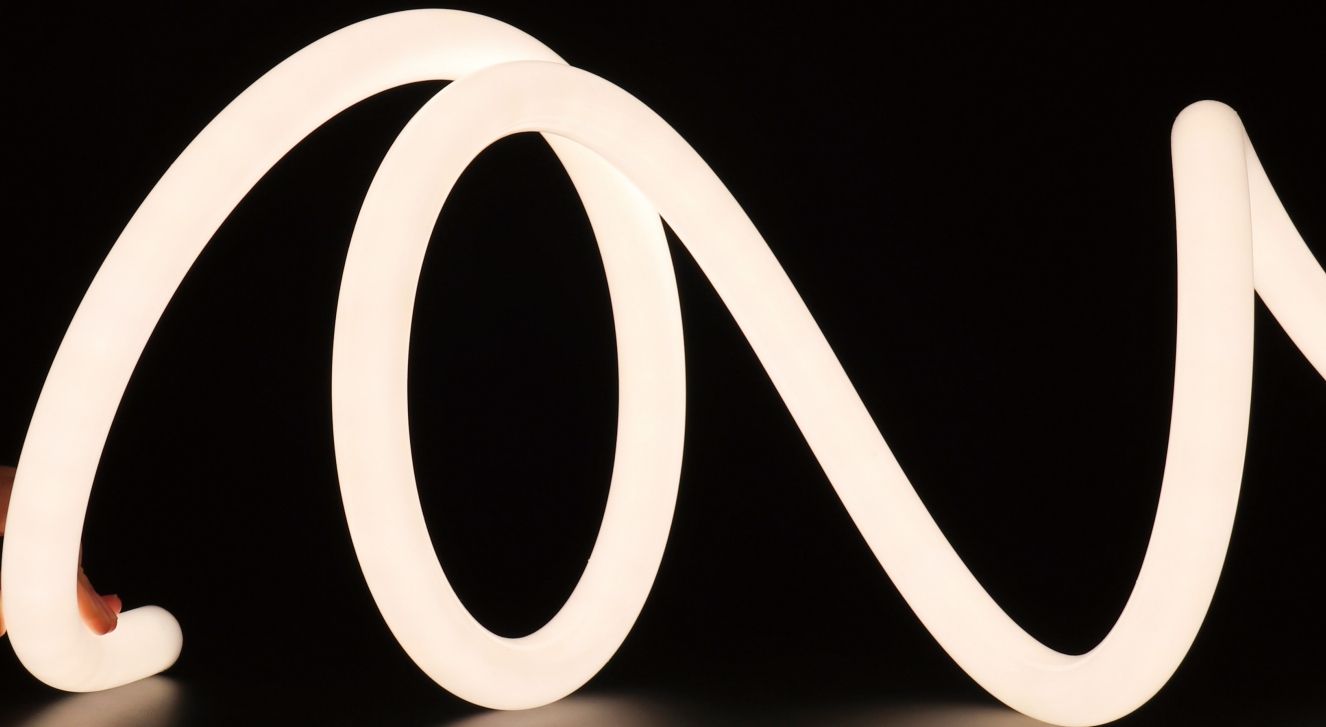

< Features

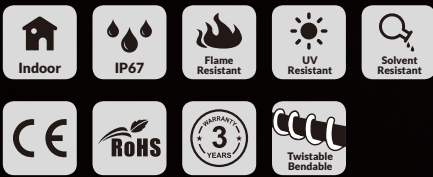
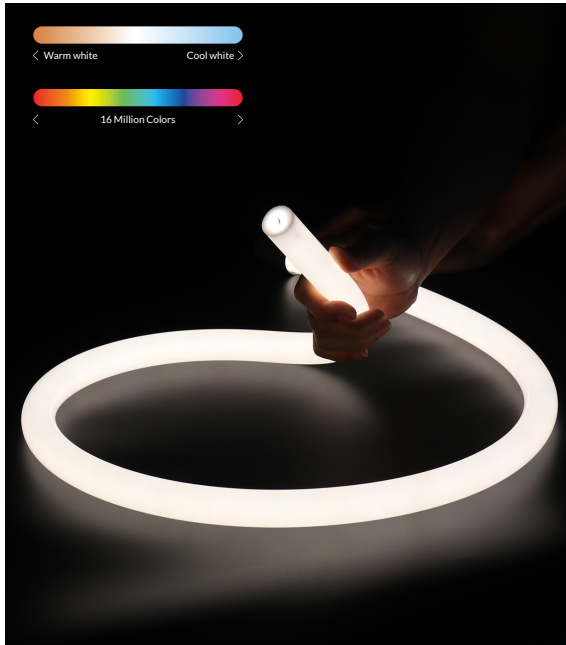

- New technology silicone extrusion, 360° beam angle, uniform light emission and no light spots.
- Unique extrusion process and design can be bent arbitrarily
- Operating/storage temperature. Ta: -25~55°C / 0°C~80°C
- Environmental characteristics: salt solution resistance, acid and alkali resistance, corrosion resistance, flame retardant resistance.
- IP rating: silicone extrusion, IP67 protection
- Flexible material to make different shapes, more possibilities for LED aesthetics.
- CE, RoHS certification, longer life time, 3 years warranty

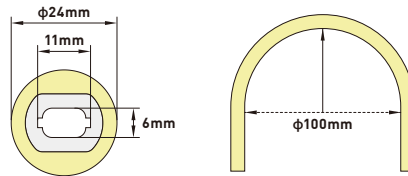

< Specifications

Model No.	ND24D
Size	φ24mm
Material	Silicone
Light transmittance	75%
Extrusion process	Dual color extrusion
PCB limited (mm)	10mm
Weight/m	580g
IP Rating	IP65
Working temperature	-25~80°C
Beam angle	360°
Bending diameter	φ100mm
Warranty	3 years
Application	Office / Home / Hotel / Exhibition / Hall

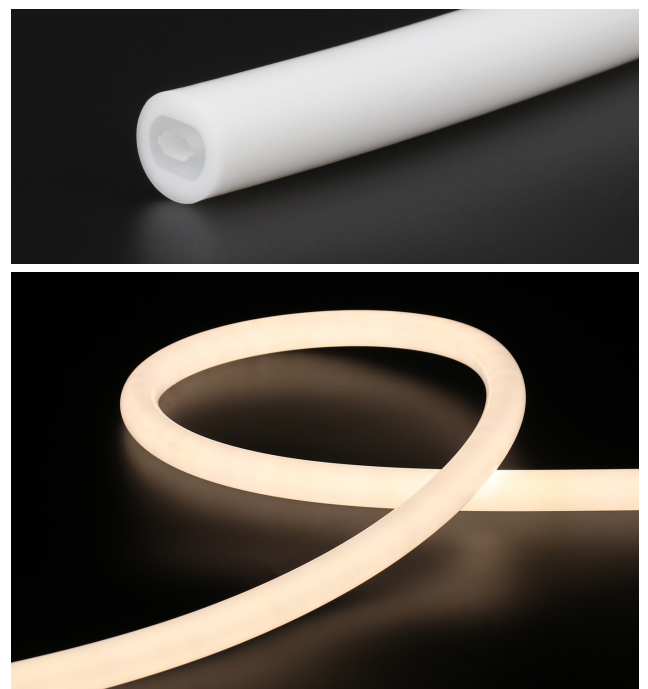

< Dimension

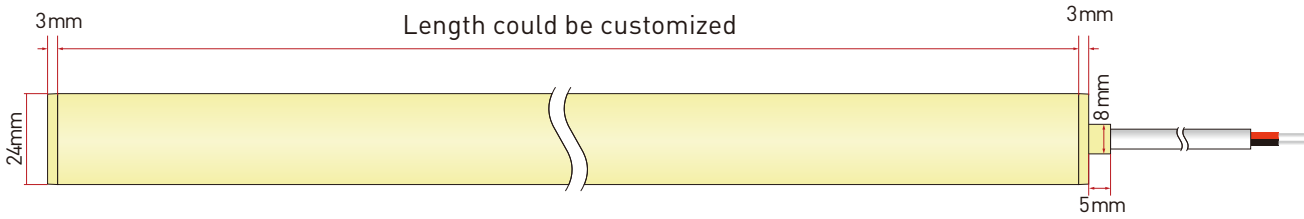

< Cutting guidance

Note: The cutting length of the neon tube should be within 5mm longer than the LED Strip.

eg. If the length of LED strip is 2m, the cutting length of the neon tube should be 2m-2.05m.

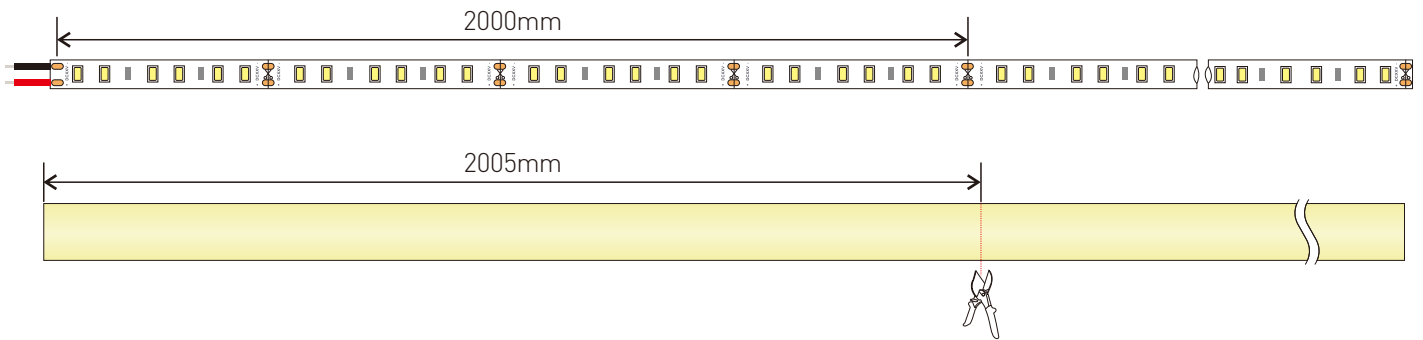



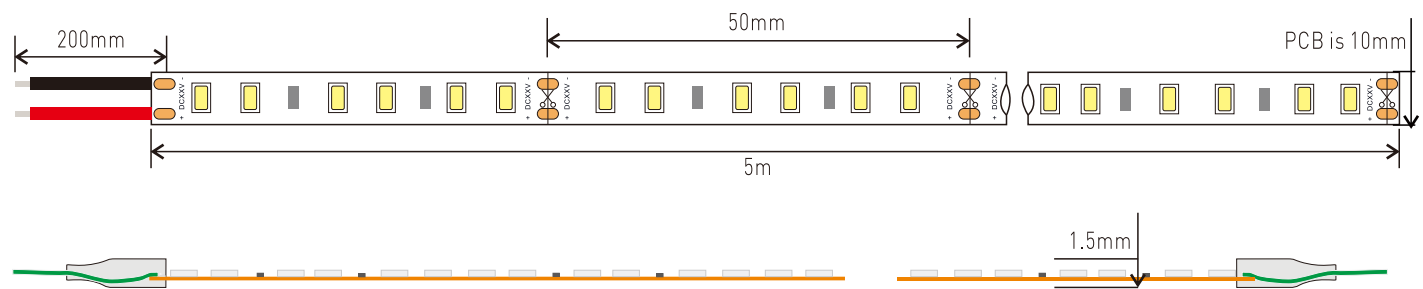





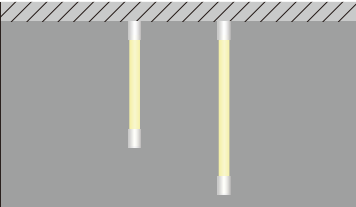

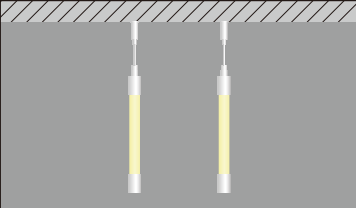

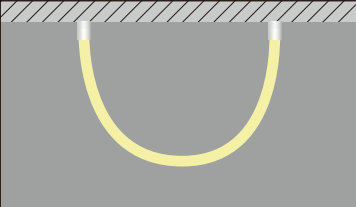

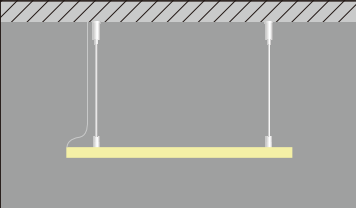

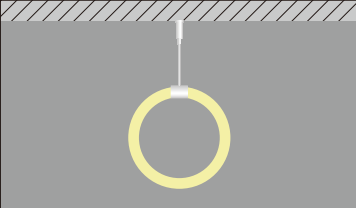
< Recommended Led Strip parameters

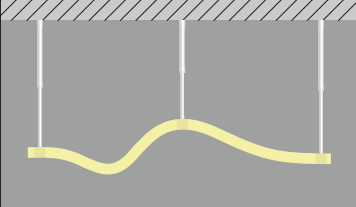

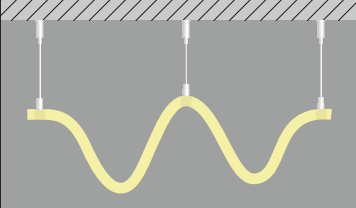
SMD2835, 120 LED/Meter								
Model No.	Color	Lumen/M	Cut every (LEDS)	LED Qty/M	Voltage	Power/M	PCB Width	Packing/M
SUR-2835FWW120-24V	WW	850	6	120	24V	9.6W	10mm	5 Meters/reel
SUR-2835FNW120-24V	NW	950						
SUR-2835FCW120-24V	CW	1050						

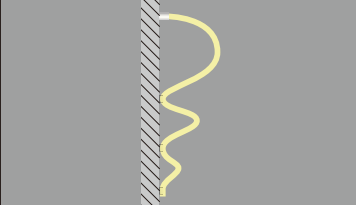
< Accessories

Model No.	Application	Accessories picture	Packing List	Accessories list
AS-ND24D-A (Vertical ceiling)			Quantities 20set N.W 0.35KG Total weight 8.2KG Package size L1070*W180*H145	1 meter round PC tube 1 pc Vertical Ceiling installation aluminum end cap 2 pcs fixed aluminum end caps 1 pc aluminum end cap without Rope 2 pcs silicone end caps (1pc with hole, 1pc without hole) 8 pcs screws 2 pcs white plastic anchors 1 pc Phillips screwdriver 1 pc M4 hexagonal wrench
AS-ND24D-B (Vertical hoisting)			Quantities 20set N.W 0.45KG Total weight 10.2KG Package size L1070*W180*H145	1 meter round Plastic tube 1 pc Vertical Hoisting installation aluminum end cap 1 pc 1 meter Conductive Steel Rope with cable inside 1 pc aluminum end cap without hole 2 pcs silicone end caps (1pc with hole, 1pc without hole) 7 pcs screws 1 pc white plastic anchors 1 pc Phillips screwdriver
AS-ND24D-C (Double-head ceiling)			Quantities 73set N.W 0.11KG Total weight 9.2KG Package size L468*W375*H237	2 pcs Vertical Ceiling installation aluminum end caps 2 pcs fixed aluminum end caps 2 pcs silicone end caps (1pc with hole, 1pc without hole) 10 pcs screws 4 pcs white plastic anchors 1 pc Phillips screwdriver 1 pc M4 hexagonal wrench
AS-ND24D-D (Horizontal hoisting)			Quantities 20set N.W 0.34KG Total weight 8KG Package size L1070*W180*H145	1 meter round Plastic tube assembled with hanging clips 2 pcs steel rope with copper bolts 2 pcs screws for steel rope bolts 2 pcs silicone end caps (1pc with hole, 1pc without hole) 2 pcs white plastic anchors
AS-ND24D-E (Round hoisting)			Quantities 73set N.W 0.1KG Total weight 8.5KG Package size L468*W375*H237	2 pcs thread locker 2 pcs side outlet aluminum end caps 2 pcs silicone end caps without hole 7 pcs screws 1 pcs plastic anchors 1 pc Phillips screwdriver
AS-ND24D-F (Telescopic rod ceiling)			Quantities 24set N.W 0.17KG Total weight 5.2KG Package size L400*W180*H145	1 set of assembled telescopic rods (the telescopic distance can be adjusted between 300MM-600MM) 1 pc white plastic anchors 1 pc screw
AS-ND24D-G (Steel Rope Ceiling)			Quantities 146set N.W 0.05KG Total weight 8.5KG Package size L468*W375*H237	1 pc 1.5m assembled steel rope (including 30MM round PC tube + 30MM PC clips + 2pcs copper bolts) 1 pc screw 1 pc white plastic anchors
AS-ND24D-H (Wall Mounting)			Quantities 73set N.W 0.09KG Total weight 7.7KG Package size L468*W375*H237	1 pc Vertical Ceiling installation aluminum end cap 1 pcs fixed aluminum end cap 2 pcs silicone end caps (1pc with hole, 1pc without hole) 3 pcs 30MM PC clips 11 pcs screws 2 pcs white plastic anchors 1 pc Phillips screwdriver 1 pc M4 hexagonal wrench

< Controller wiring diagram

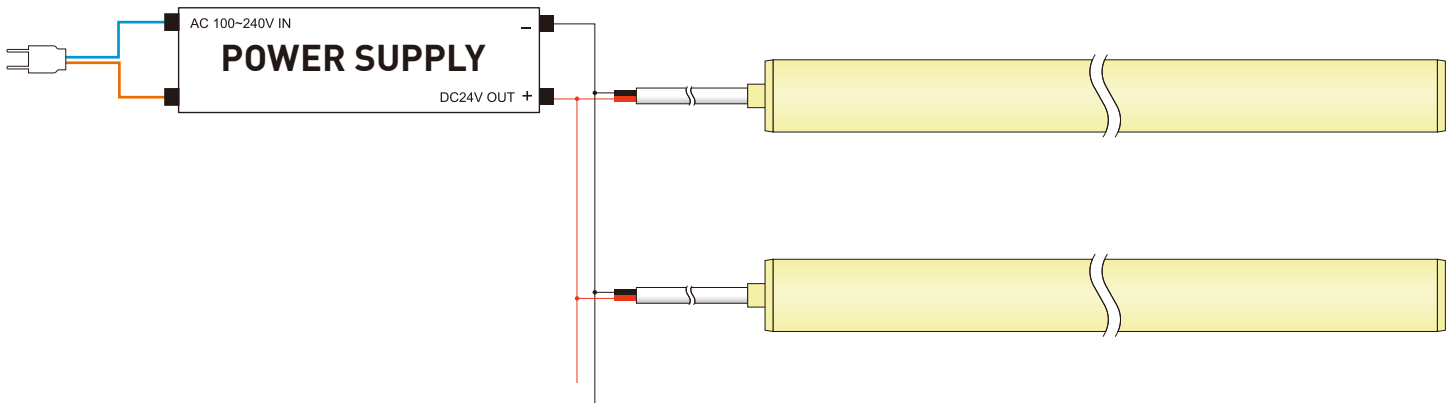

< Installation of clip

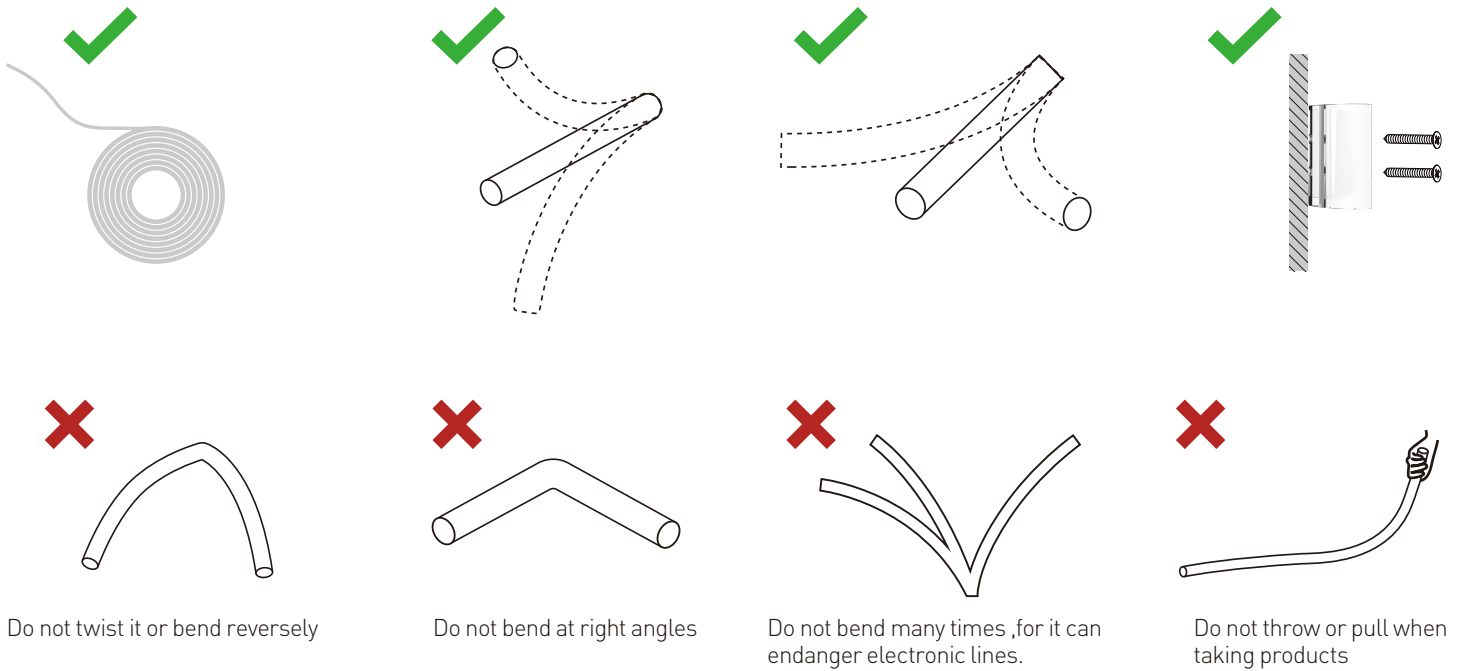

< Installation/Usage Precautions

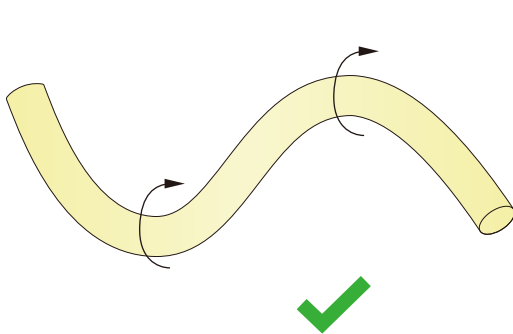

Bending diameter should be more than $\phi 100\text{mm}$

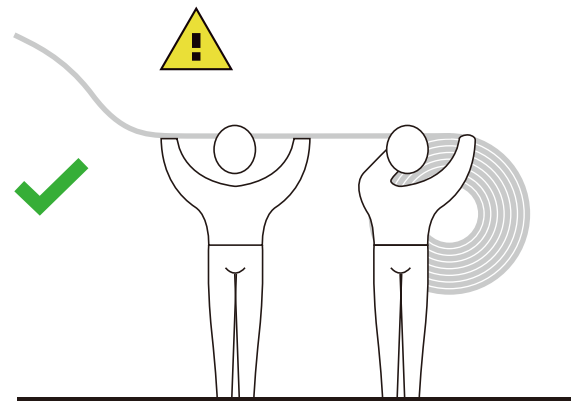

If the length of LED strip is over 2m, it is recommended to install by two persons.

< Package of Neon Strip (5M/Roll)



< Package of Silicone tube (30M/Roll)

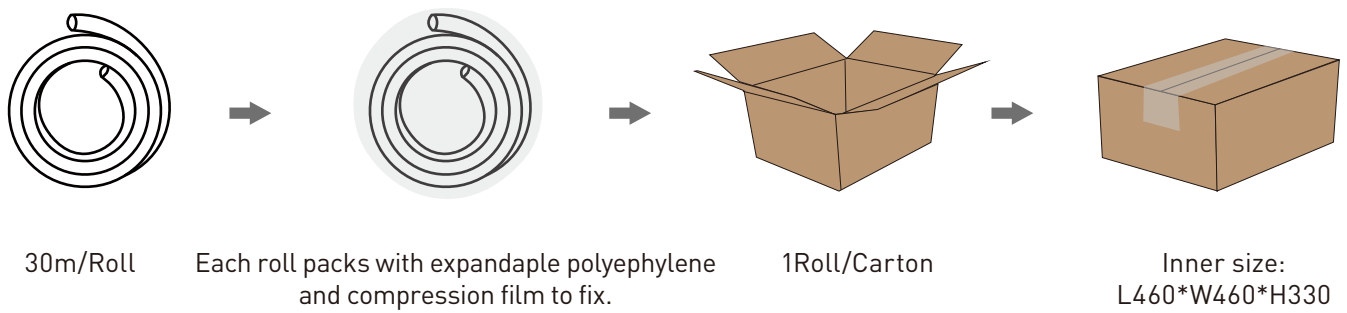

< Application

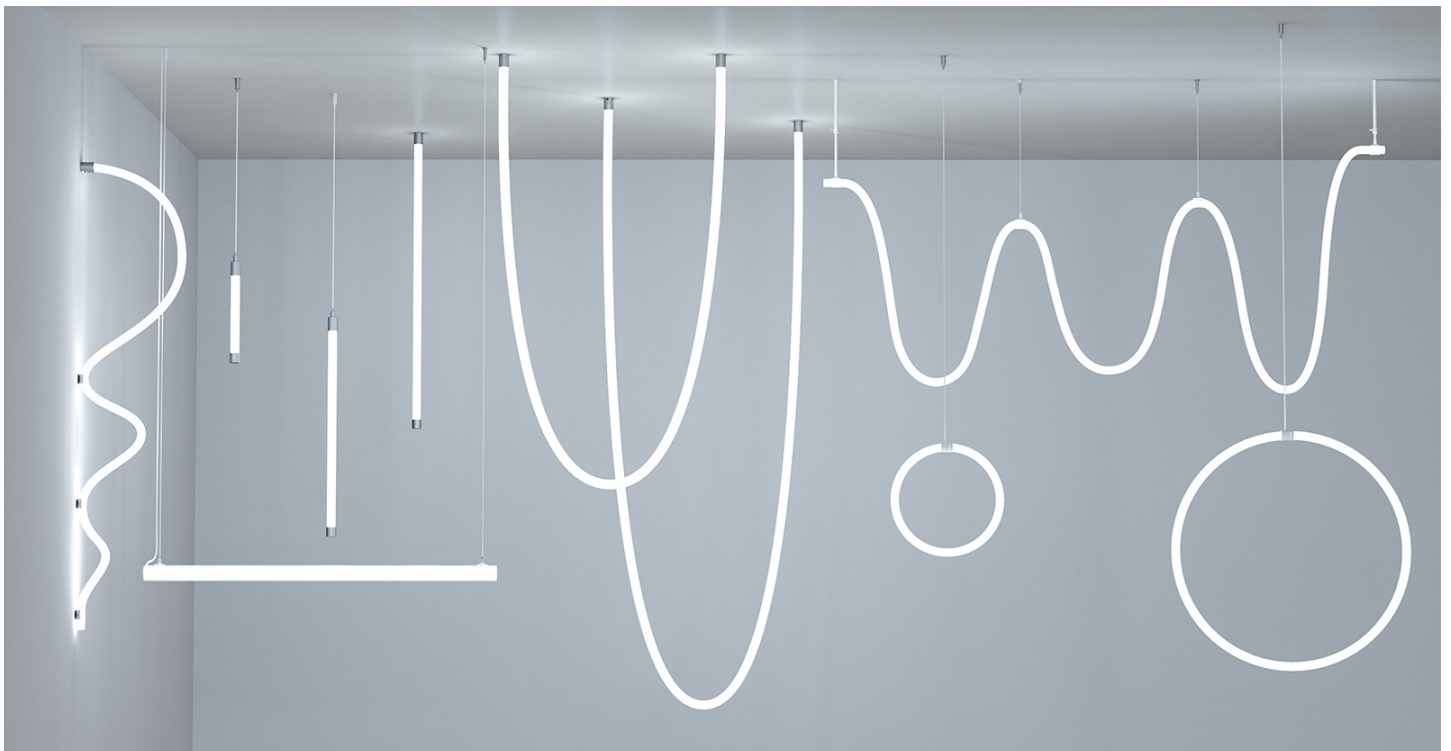

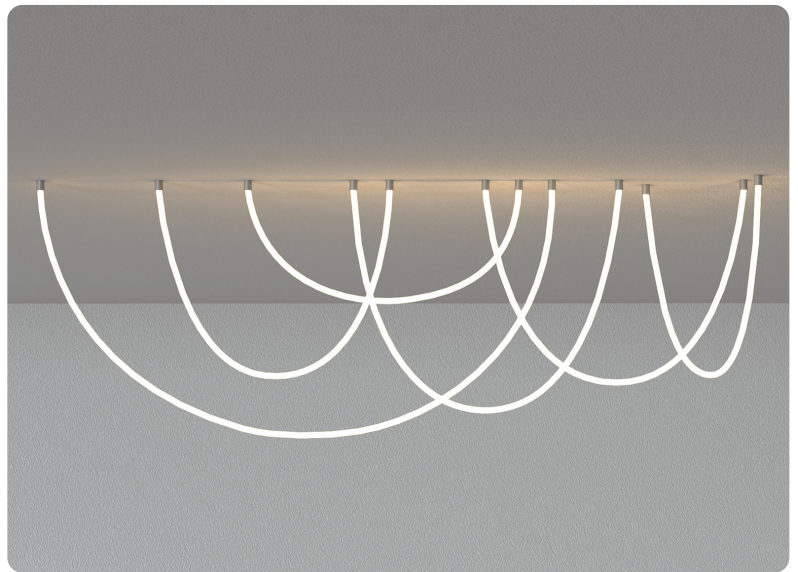
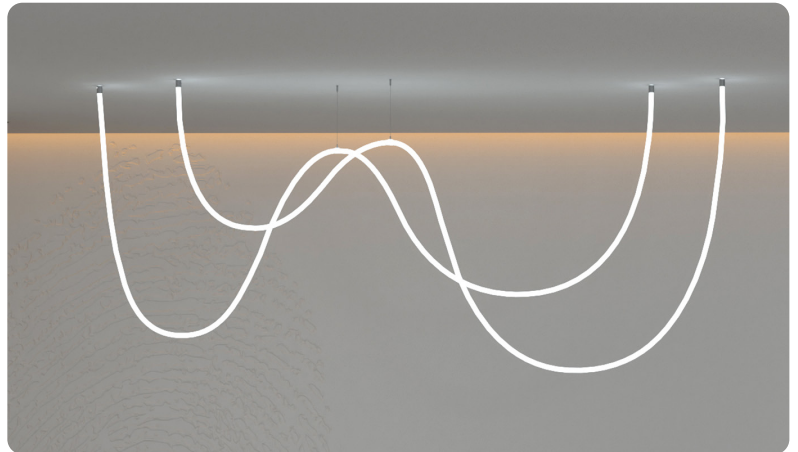

< Cautions

- Please do not touch the AC power terminal when the power supply is connected in case of the electric shock.
- Please pay attention to the positive and negative poles of the power cord in connection.
 [The voltage of the power supply and the product should be same so as to avoid damage of the product]
- When installing, no scratching, twisting and irregular bending of the product.
- To guarantee the lifetime and reliability of the light strip, please do not bend it in an arc with a semi-diameter of 100mm or less.
- If the actual application length exceeds the standard length, it will cause overload, heat, and uneven brightness to happen to the LED strip.
- In order to protect your eyes, please do not look at the light-emitting surface of the light strip for a long time.
- Non-professionals are prohibited from installing, disassembling and repairing the product.
- It is highly prohibited to use any acidic or alkaline adhesives to fix the product (including but not limited to glass glue, etc.).
- Please use professional cutting tools when you are cutting.