

**IP67**

# **N1020B**

**LED Neon Flex Silicone Tube**

---

**Product Specification**

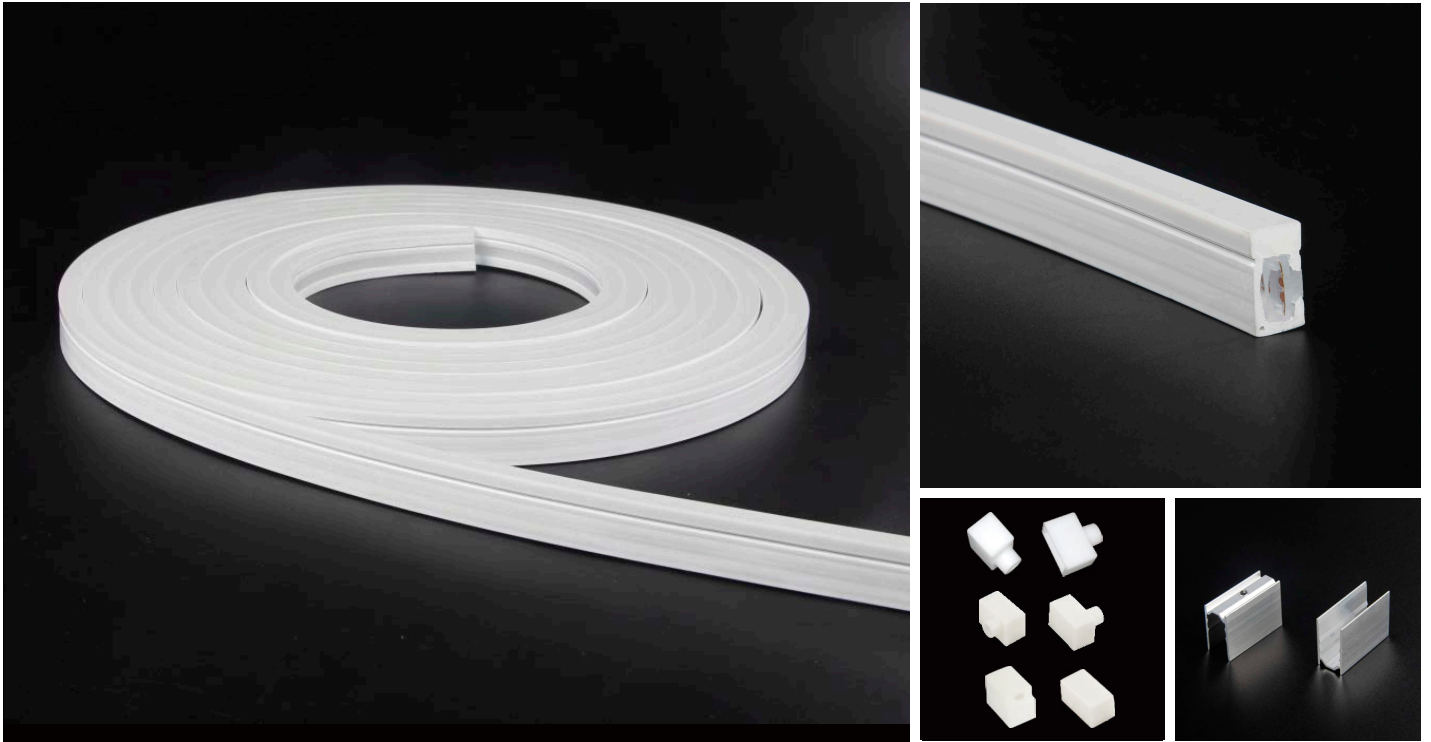

## Product Features

- At-yellowing and heat resisting silicone glue, chemical resistance acid and alkaline, available for extremely terrible outdoor environment.
- Uniform and soft luminance, no light spot.
- Super brightness large chip, golden wire welded and copper led holder for quicker heat dissipation, higher stability, longer life span.
- Leadless SMT technique (RoHS certificated), smooth welding joint, firm connection of LED and pcb.



## LED strip colloid specifications comparison

Materials Main parameters	Silicone flexible led strip	PVC flexible led strip	Notes
Colloid features in -40 ℃	No crack after 30 days	Totally cracked	The low temperature resistant of silicone is superior than PVC or epoxy materials
Colloid features in 120 ℃	No obvious change after 72 hours	Colloid changed into yellow and deformed after 2 hours	The high temperature resistant of silicone is superior than PVC or epoxy
Colloid features in 180 ℃	No obvious change after 72 hours	Colloid changed into brown and some melted after 20 minutes	Over 150 ℃ , PVC is easily hydrolyzed, Viscosity becomes weaken and easily separated
Steadily lighted in Seawater for 72 hours	No obvious change	Serious atomization on the surface	The waterproof grade of silicone led strip can reach to IP67, high resistance to acidic alkali and salt properties
Thermal conductivity	Good thermal conductivity	No thermal conductivity	Pvc and epoxy cannot conduct heat, while silicone has good thermal conductivity

## Structure & Spec.

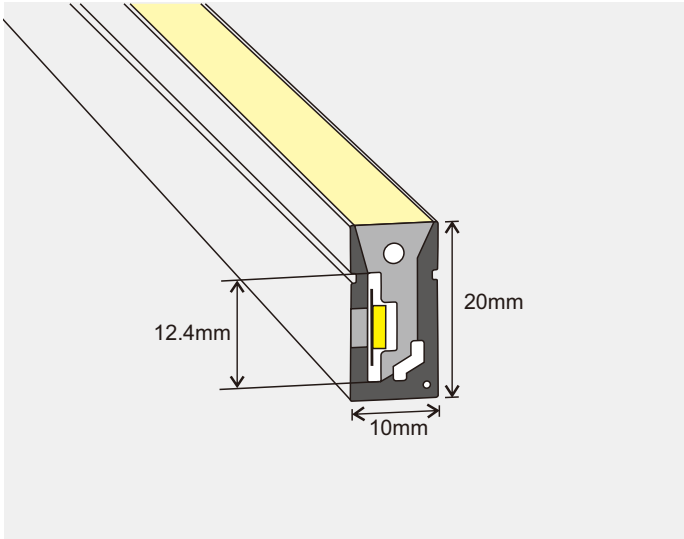

Size (mm)	10*20
PCB Limited (mm)	8-10
IP Grade	IP67
Working Temperature	-20 to 50°C
N.W.(G/M)	185
Voltage (V)	12/24 DC
Watt (W/M)	14.4 Max.
LED Type	2835/3528/5050
Color	WW/NW/CW/RGB
Luminous (LM)	280
Luminous Efficiency (LM/W)	19
* This lumen is based on SMD2835-120LEDS/M inside.	
CRI (RA)	>80

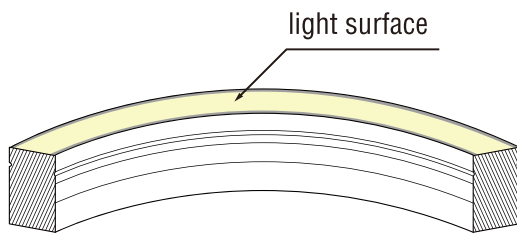

## End Caps

① Cable output straight out

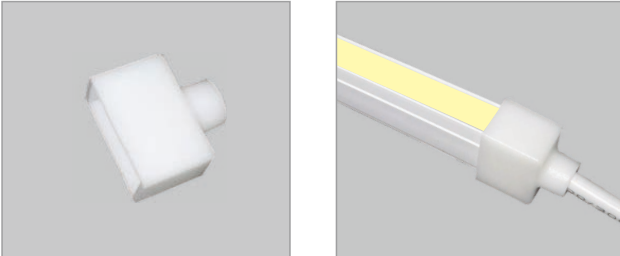

② Endcap without hole

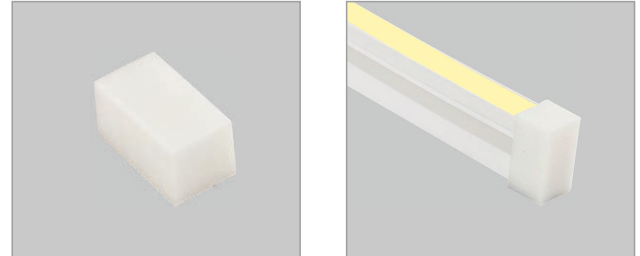

③ Cable output from left

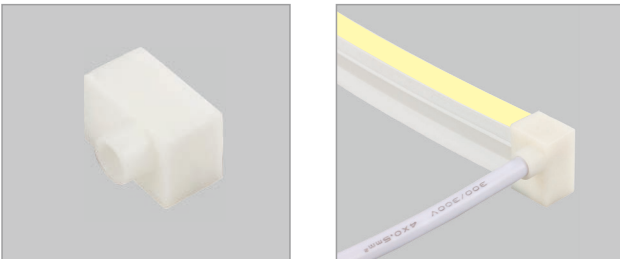

④ Cable output from right

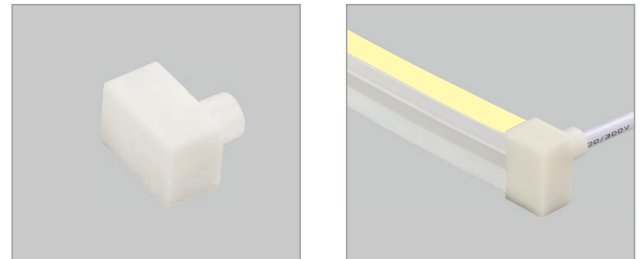

⑤ Cable output from bottom

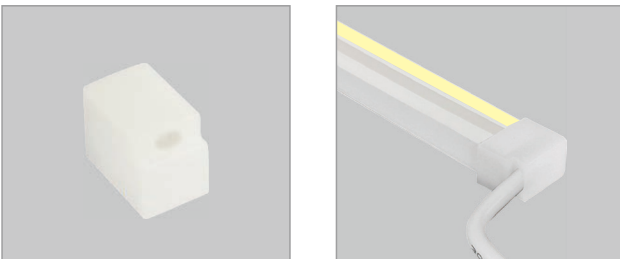

## Installation Accessories

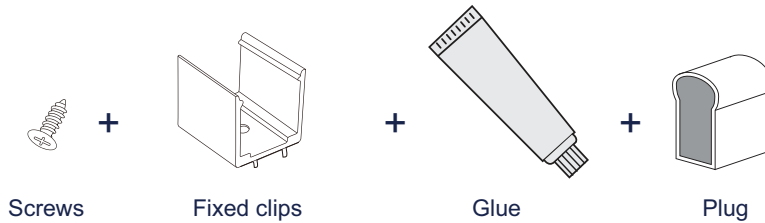

## Installation Instructions

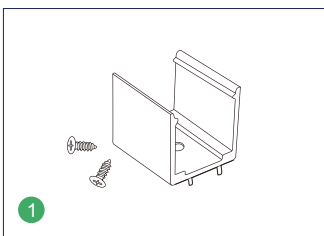
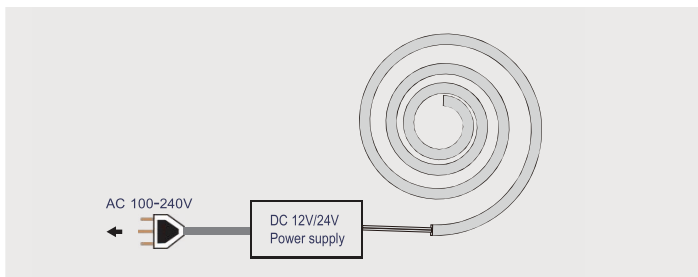

1 Prepare the screws and fixed clips

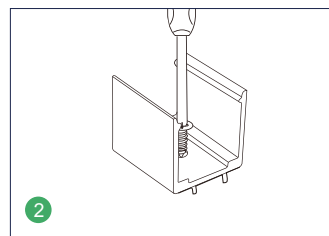

2 Adjust the fixed clips to the appropriate place, use a screwdriver to fix the screw.

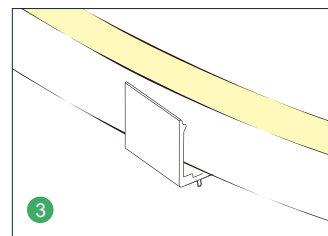

3 Put the light emitting surface upwards, then insert the LED strip into the fixed clips.

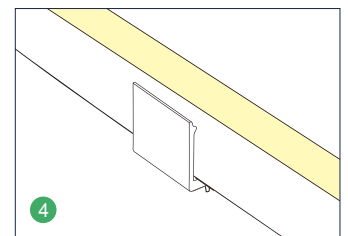

4 Fix led strip completely into the fixed clip, led strip surface must be parallel to the top edge of fixed clip.

## Packaging



50m/Roll



Each roll pack with expandable polyethylene and compression film to fix.



1Roll/box



Inner size  
355x355x305mm

## Cautions

- Please notice that the strips are not bendable to all directions. As the appropriate specific shape and degree, please follow the following instruction.
- LED strips are low voltage products, you must use the power supply (transformer). Please don't connect the led strip directly to the AC 110V or AC 220V. Otherwise, it will burn out the LED strips and lead to safety (security) accidents.
- Please read the specifications thoroughly before installation by professional staff to make sure the safe use.

### Wrong bending way

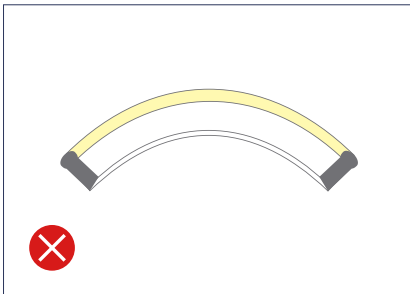

Face to the side surface (as the picture shows). Do not bend downward to damage the strip.

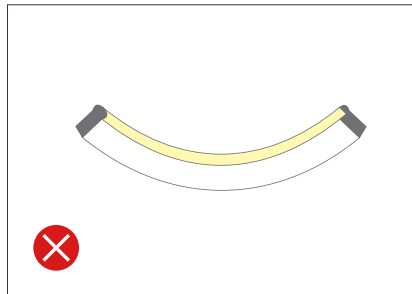

Face to the side surface (as the picture shows). Do not bend upward to damage the strip.



As the picture shows, please do not twist the strip, or it will be damaged.

### Correct bending way

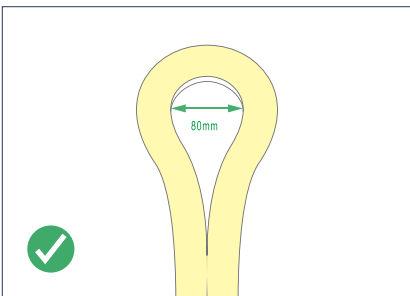

Face to the light surface, fold the strip, the minimum bending diameter is 80mm.

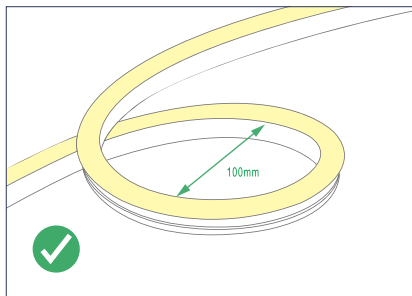

Light surface upwards, the strip is bendable to right or left naturally, the minimum bending diameter is 100mm.