



IP67

N1010B

LED Neon Flex Silicone Tube

Product Specification

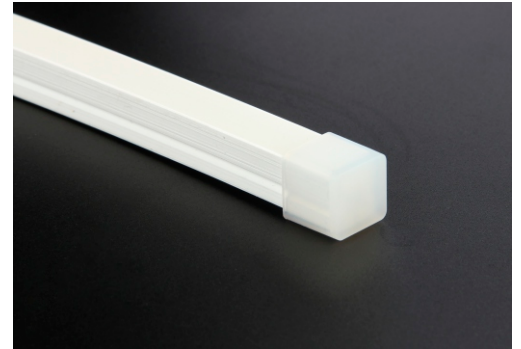
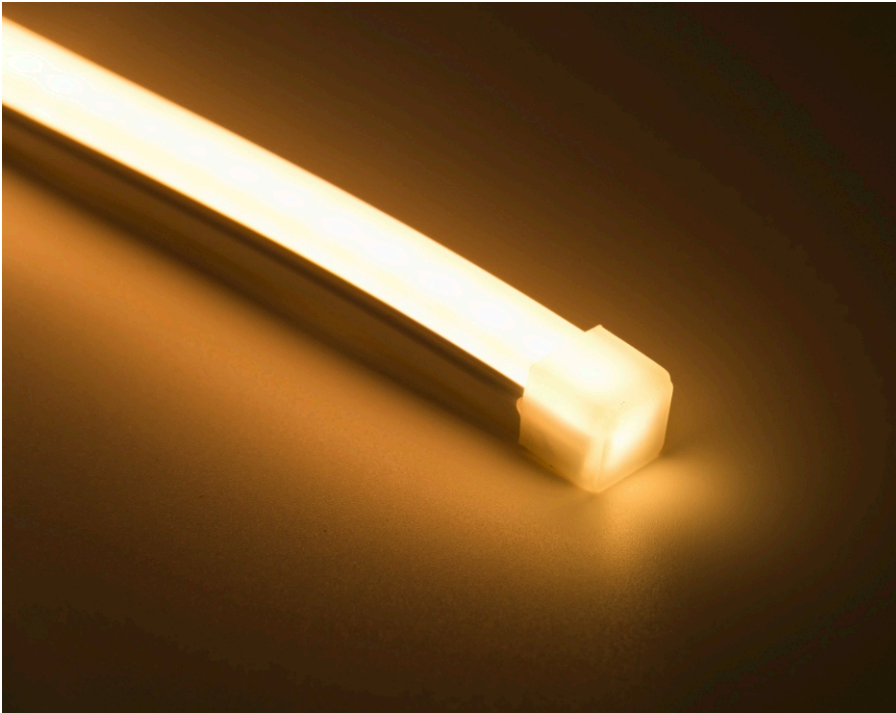

Product Features

- At-yellowing and heat resisting silicone glue, chemical resistance acid and alkaline, available for extremely terrible outdoor environment.
- Uniform and soft luminance, no light spot.
- Super brightness large chip, golden wire welded and copper led holder for quicker heat dissipation, higher stability, longer life span.
- Leadless SMT technique (RoHS certificated), smooth welding joint, firm connection of LED and pcb.



LED strip colloid specifications comparison

Materials Main parameters	Silicone flexible led strip	PVC flexible led strip	Notes
Colloid features in -40 ℃	No crack after 30 days	Totally cracked	The low temperature resistant of silicone is superior than PVC or epoxy materials
Colloid features in 120 ℃	No obvious change after 72 hours	Colloid changed into yellow and deformed after 2 hours	The high temperature resistant of silicone is superior than PVC or epoxy
Colloid features in 180 ℃	No obvious change after 72 hours	Colloid changed into brown and some melted after 20 minutes	Over 150 ℃ , PVC is easily hydrolyzed, Viscosity becomes weaken and easily separated
Steadily lighted in Seawater for 72 hours	No obvious change	Serious atomization on the surface	The waterproof grade of silicone led strip can reach to IP67, high resistance to acidic alkali and salt properties
Thermal conductivity	Good thermal conductivity	No thermal conductivity	Pvc and epoxy cannot conduct heat, while silicone has good thermal conductivity

Structure & Spec.

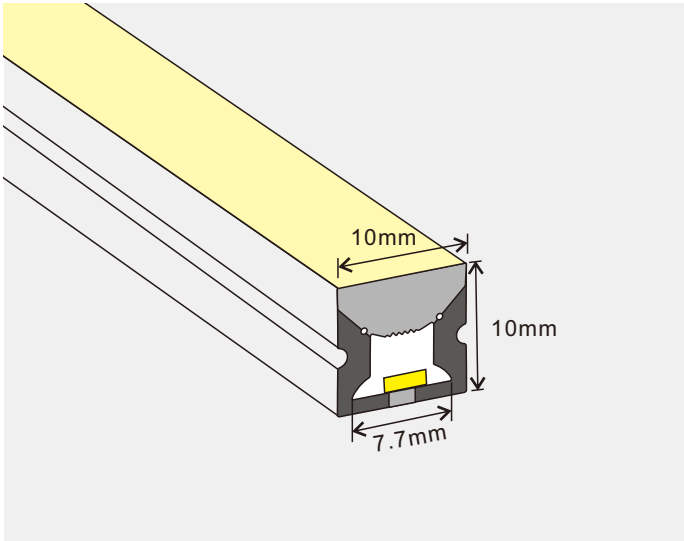

Size (mm)	10*10
PCB Limited (mm)	5-6
IP Grade	IP67
Working Temperature	-20°C to +50°C
N.W.(G/M)	85
Voltage (V)	12/24 DC
Watt (W/M)	14.4 Max.
Color	WW/NW/CW
Luminous (LM)	770
Luminous Efficiency (LM/W)	53
* This lumen is based on SMD2835-120LEDS/M inside.	
CRI (RA)	>80

Endcaps

1, Straight cable output:

Connects light to power supply with pre-installed end feed cable, Ip67.
Cable length available in 0.2m, 1m, 2m etc.

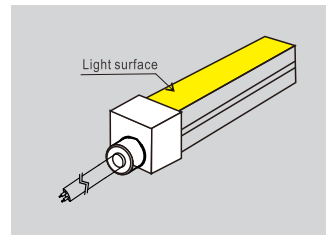
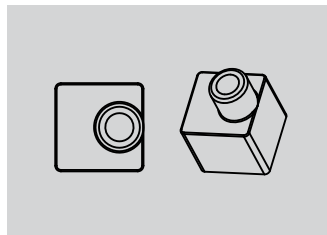

2, Cable output from side:

Connects light to power supply with pre-installed end feed cable, Ip67.
Cable length available in 0.2m, 1m, 2m etc.



Right



Left



Bottom

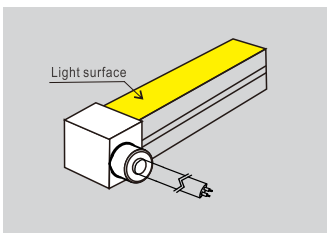
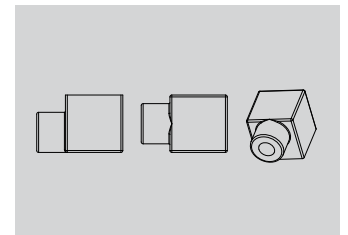

Right

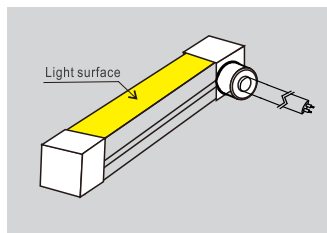

Left

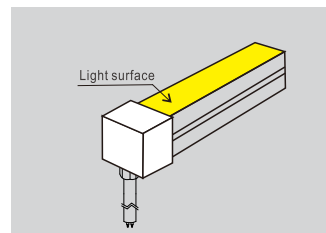

Bottom

3, End caps without hole:

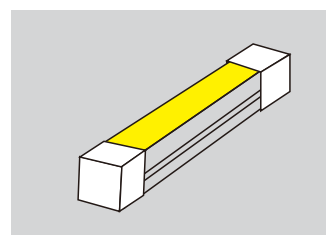
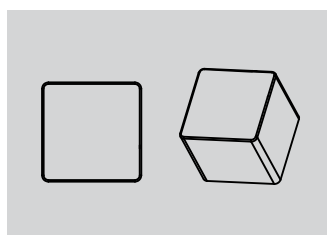

Cutting method

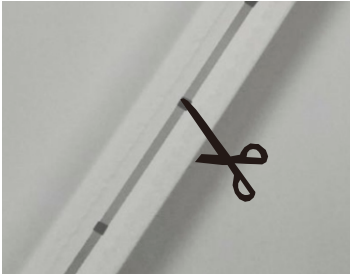

Cut it only at the cutting sign.

Mounting method

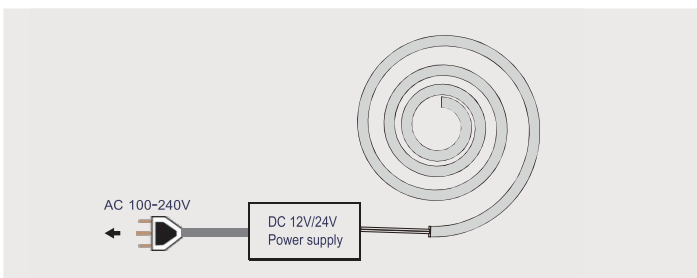

Enclose the cutting end

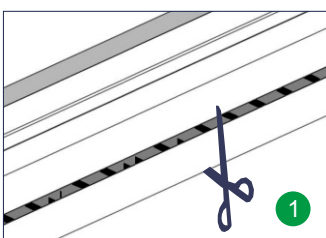

Cut the appropriate place

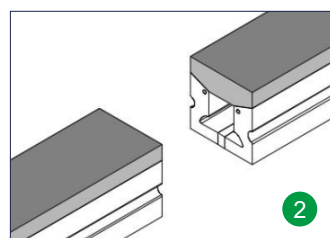

Finished the cutting

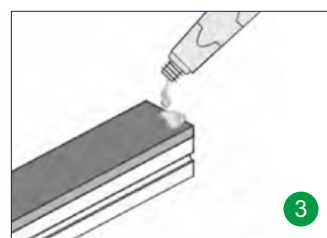

Coat the section with glue uniformly after cutting

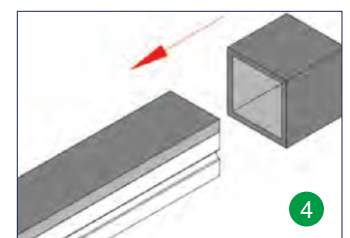

Insert the section into the plug according to direction of arrow

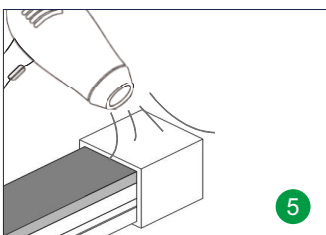

Dry the plug with hot wind or natural wind until make sure the installation is firm

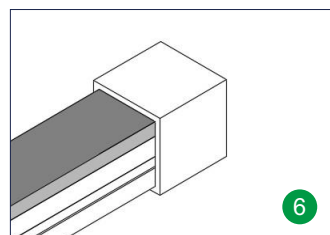

The effect of finished plug installation

Packaging



100m/Roll



Each roll pack with expandable polyethylene and compression film to fix.



1Roll/box



Inner size
355x355x155mm

Cautions

- Please notice that the strips are not bendable to all directions. As the appropriate specific shape and degree, please follow the following instruction.
- LED strips are low voltage products, you must use the power supply (transformer). Please don't connect the led strip directly to the AC 110V or AC 220V. Otherwise, it will burn out the LED strips and lead to safety (security) accidents.
- Please read the specifications thoroughly before installation by professional staff to make sure the safe use.

Wrong bending way

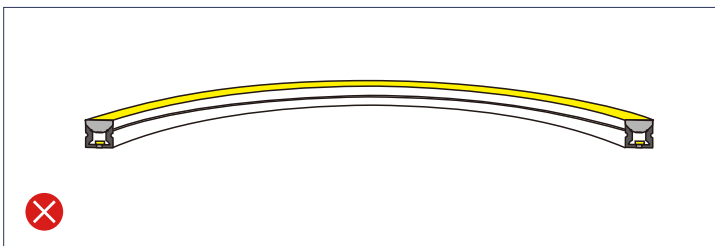

Face to the side surface (as the picture shows). Do not bend left or right to damage the strip.

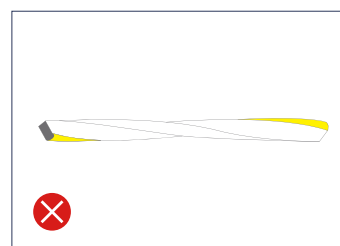

As the picture shows, please do not twist the strip, or it will be damaged.

Correct bending way

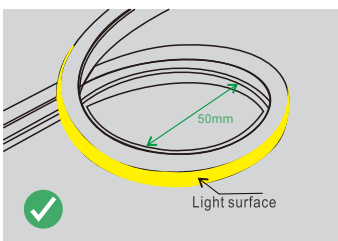

Light surface upwards, the strip is bendable to right or left naturally, the minimum bending diameter is 50mm.

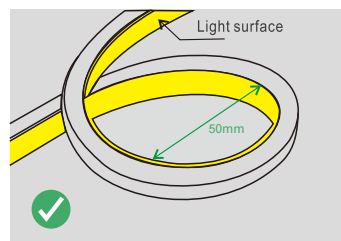

Light surface upwards, the strip is bendable to right or left naturally, the minimum bending diameter is 50mm.