

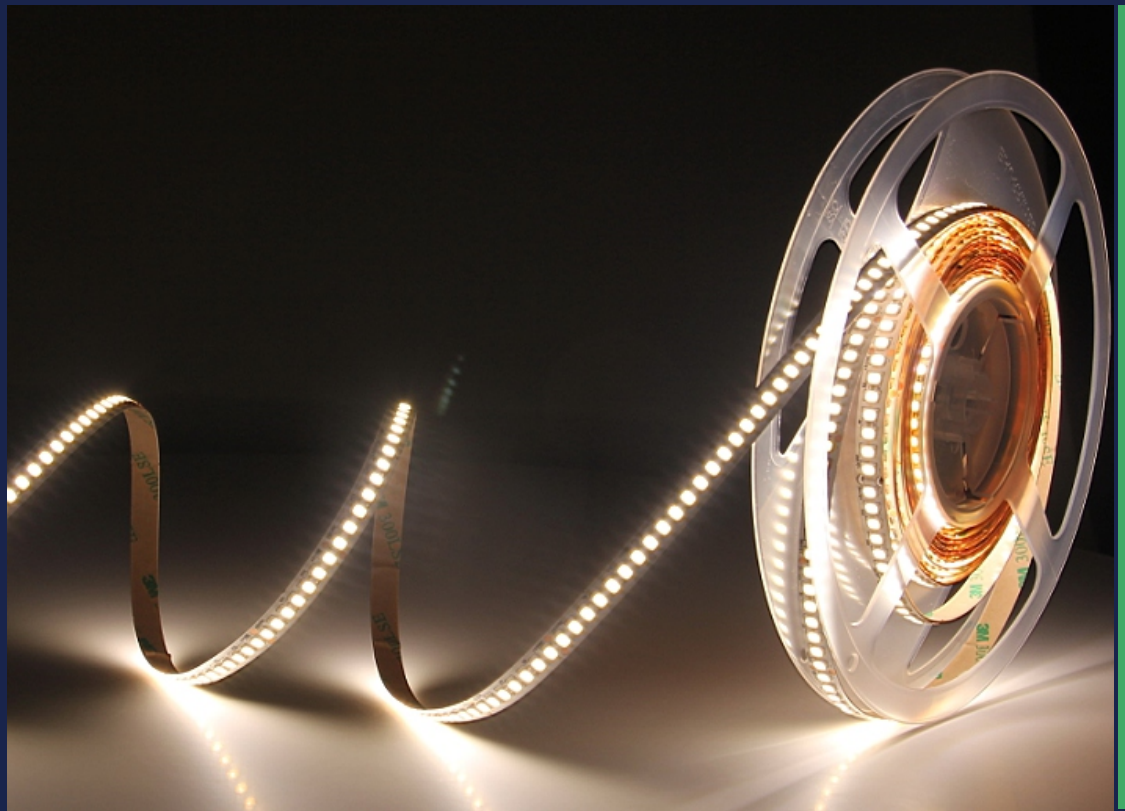

SurMountor



SUR-2835FW210-24V

FLEXIBLE STRIP introduction

Product specification

Lister: Lxlan

Assessor: 

Approver: 

Features:

- Available in 24V DC maximum.
- Very bright & low power consumption.
- Operating temperature: -20~50°C.
- Long life span LED lights, more than 50,000 hours+.
- 3M 300LSE tape.
- Non-waterproof, IP20.

Applications:

Ideal for sign letters and channel letters, concealed lights, room lighting, equipment.

Assembly drawing

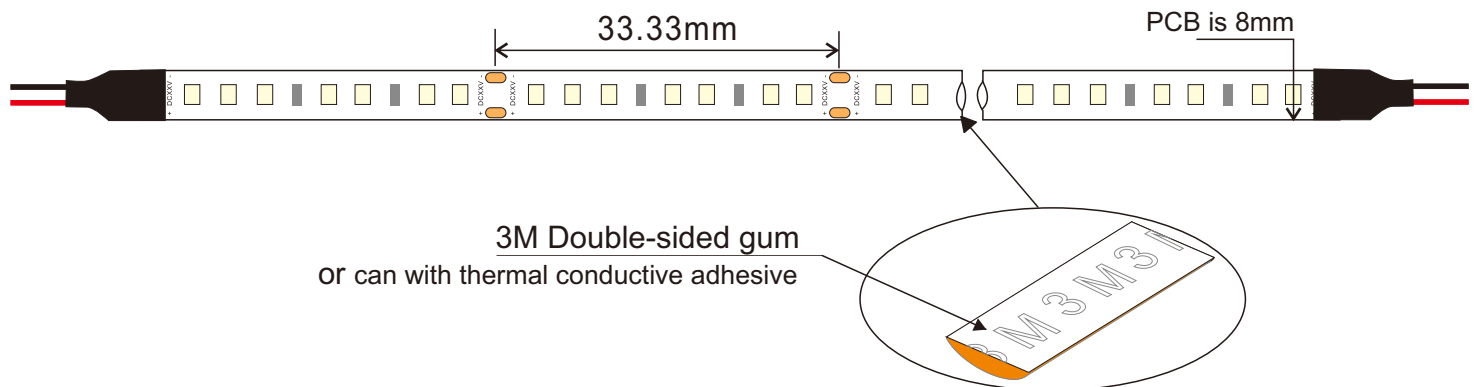

Top View



Section



SMD2835,210LED/meter

Part Number	Size	Color	Cut every (LEDS)	LED Qty/M	Lumen/M	Voltage	Power/m	Packing/m
SUR-2835FWW210-24V	L5000*W8*H3	WW 	7	210	2300	24V	21.6W	5 Meters/reel
SUR-2835FNW210-24V		NW 			2500			
SUR-2835FCW210-24V		CW 			2600			

Radiation diagram

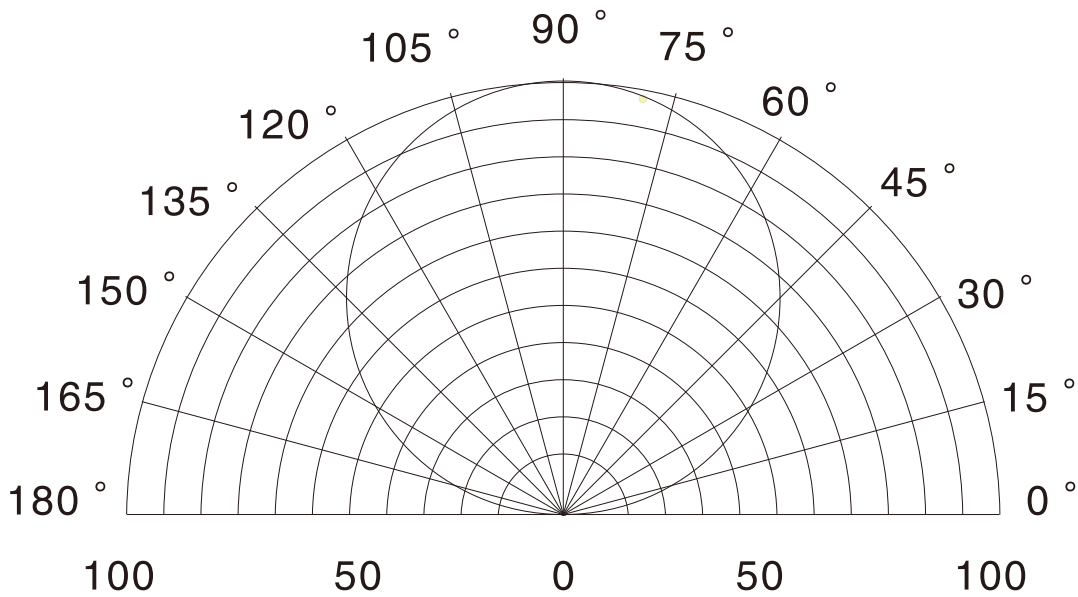

Relative luminous intensity Iv %

LED Light distribution



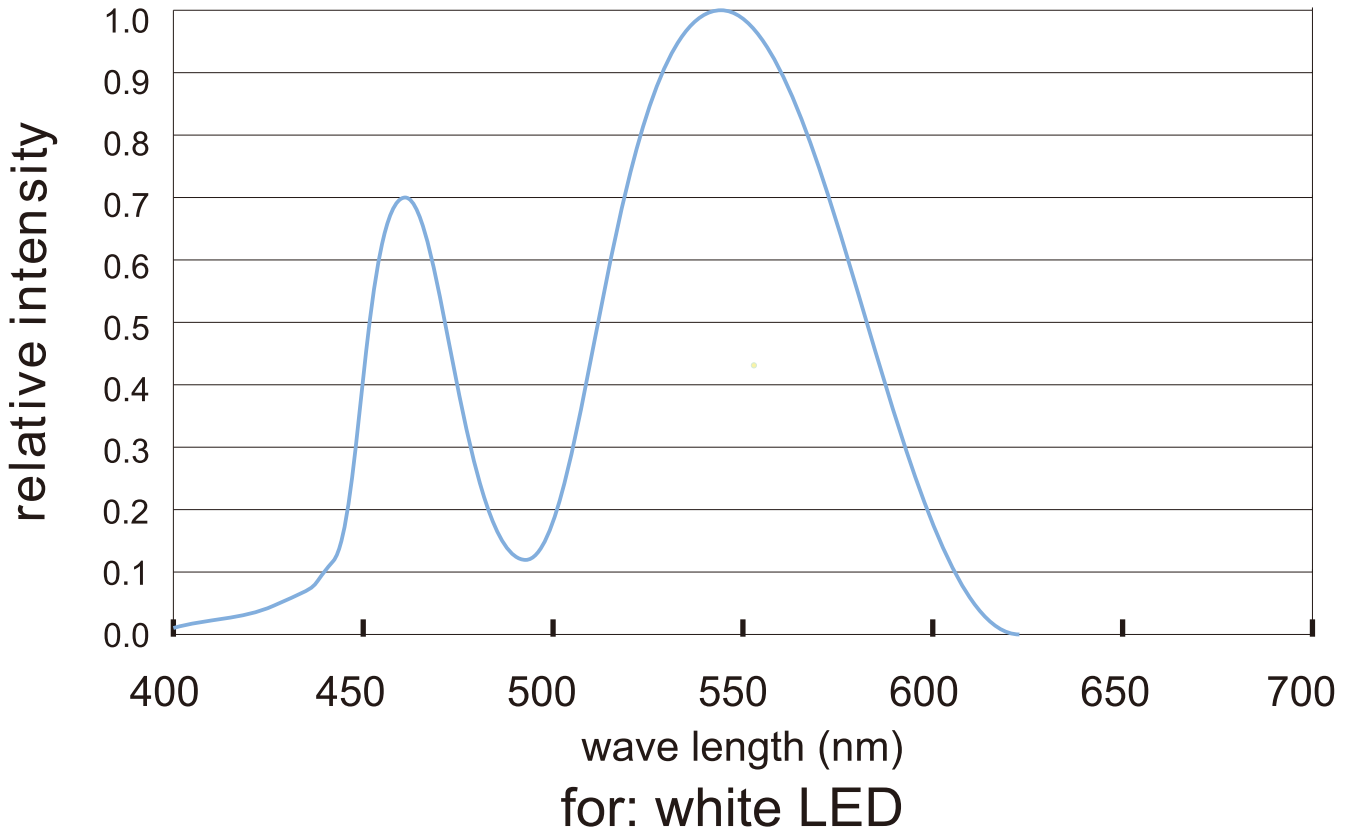

How to connect flexible strip

Below shows you how to connect the flexible strip to power supplies.

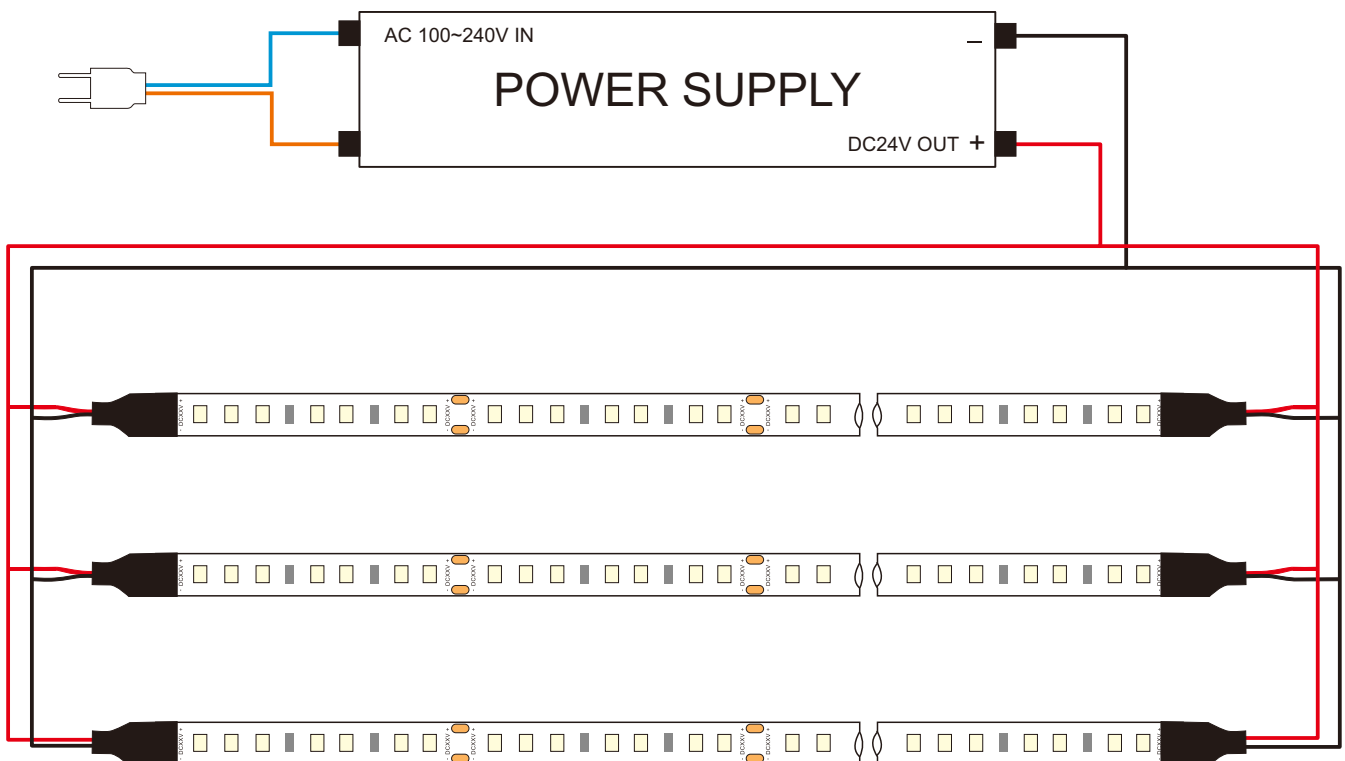

Package:

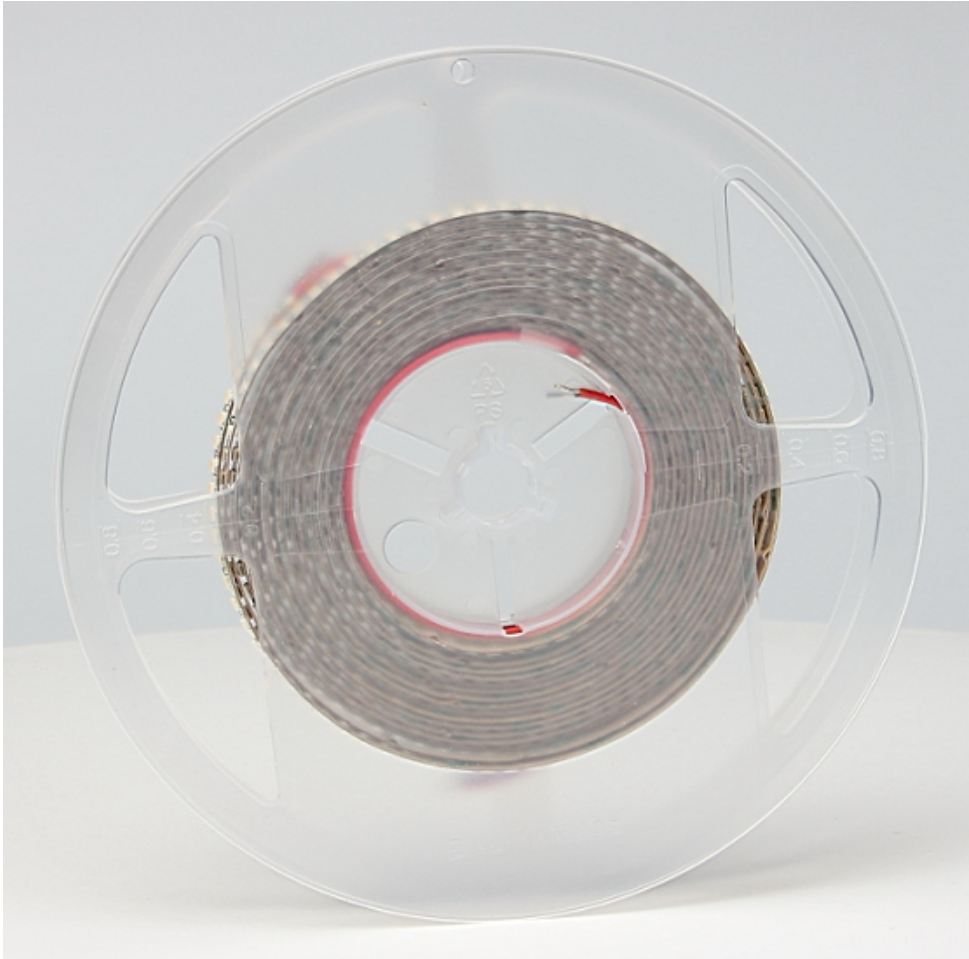

1 reel/bag



25 bags/Inner Box



Inner box
size:25x26x31cm

50 Bags/Outer Box



Outer box
size:34x52x27cm

Package: 5 meter strip in one reel, one reel in one anti-static bag, 25 bags put into one carton, 2 inner box put into 1 carton.

! Cautions:

When install the led strip, please note the installation technique. The led strip can be bent, but not distorted, as shown below:

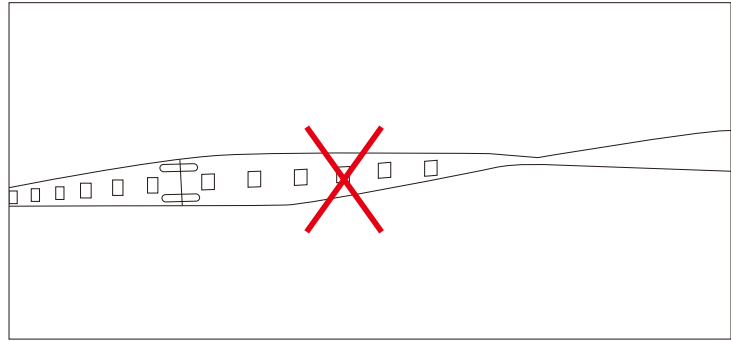
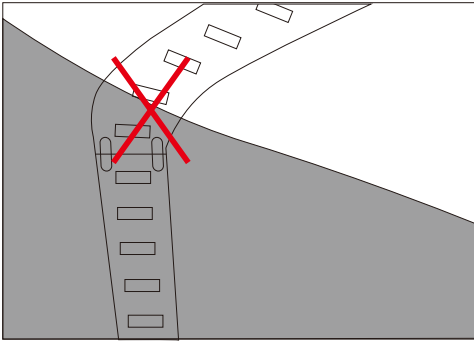
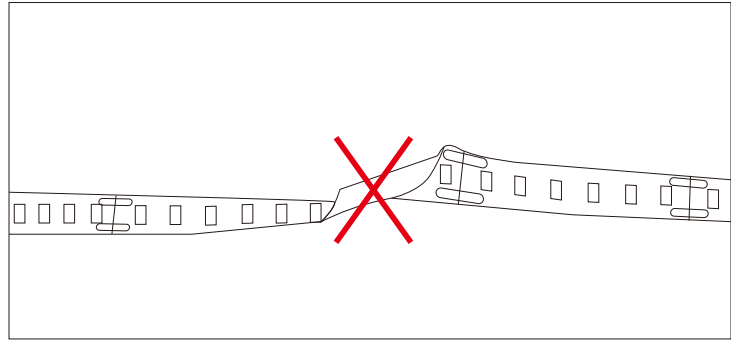
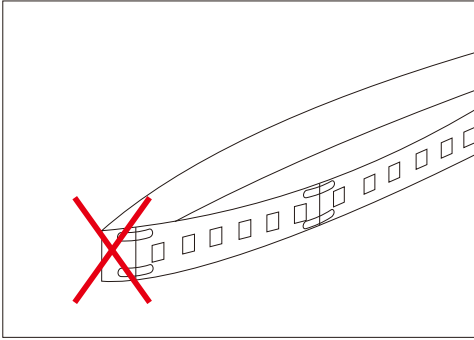
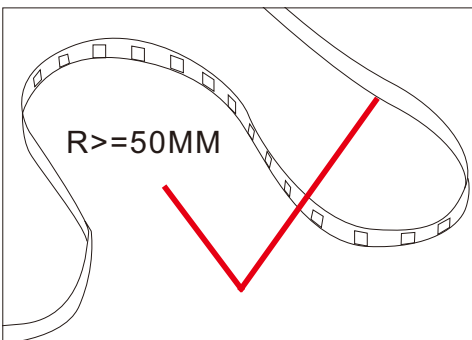
**Distortion(Wrong)****Bend (Right)**