

# LED Aluminum Profile-PE001

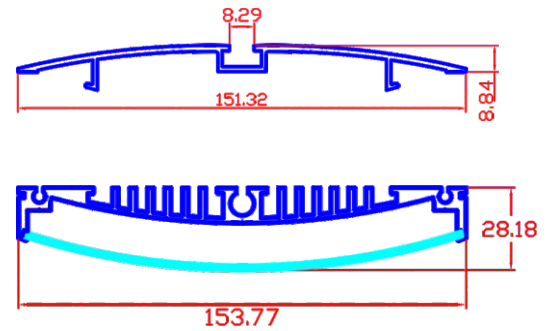

Customized Color can be ordered

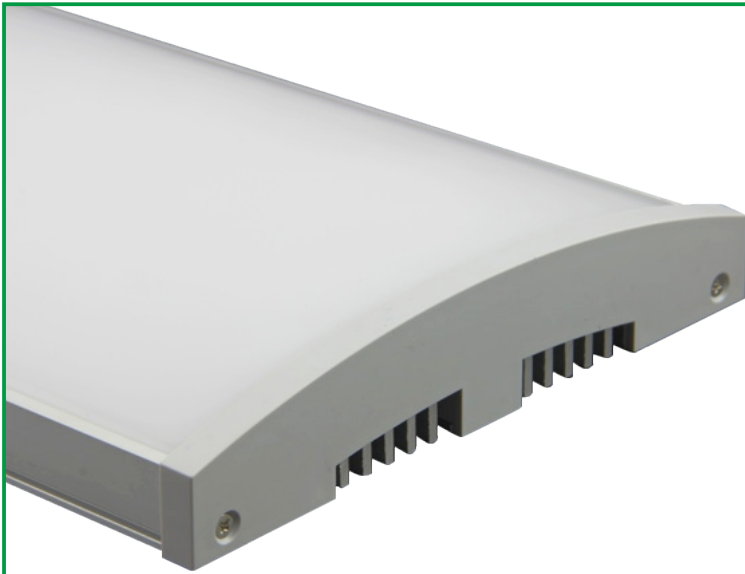
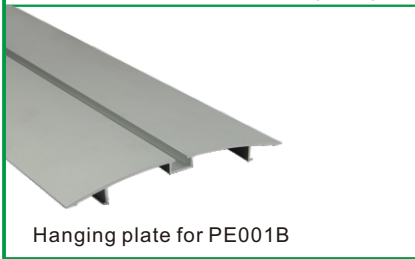
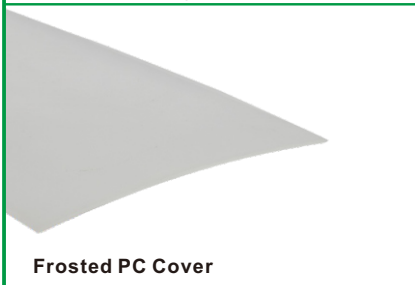

## Service Environment and Installation:

1, With screws ---10PCS of flexible LED Strips

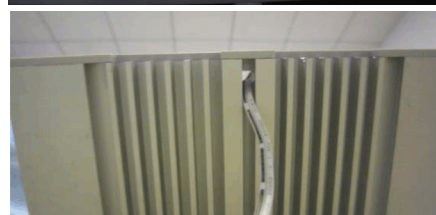
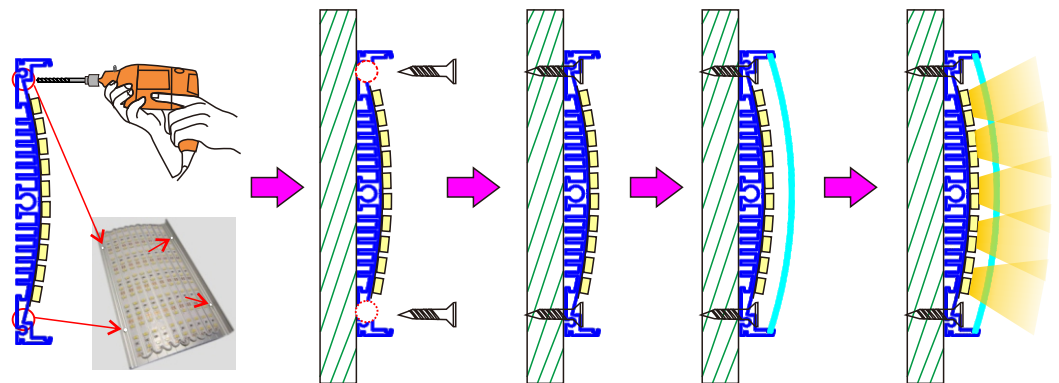

2, With PE001B and Steel Rope

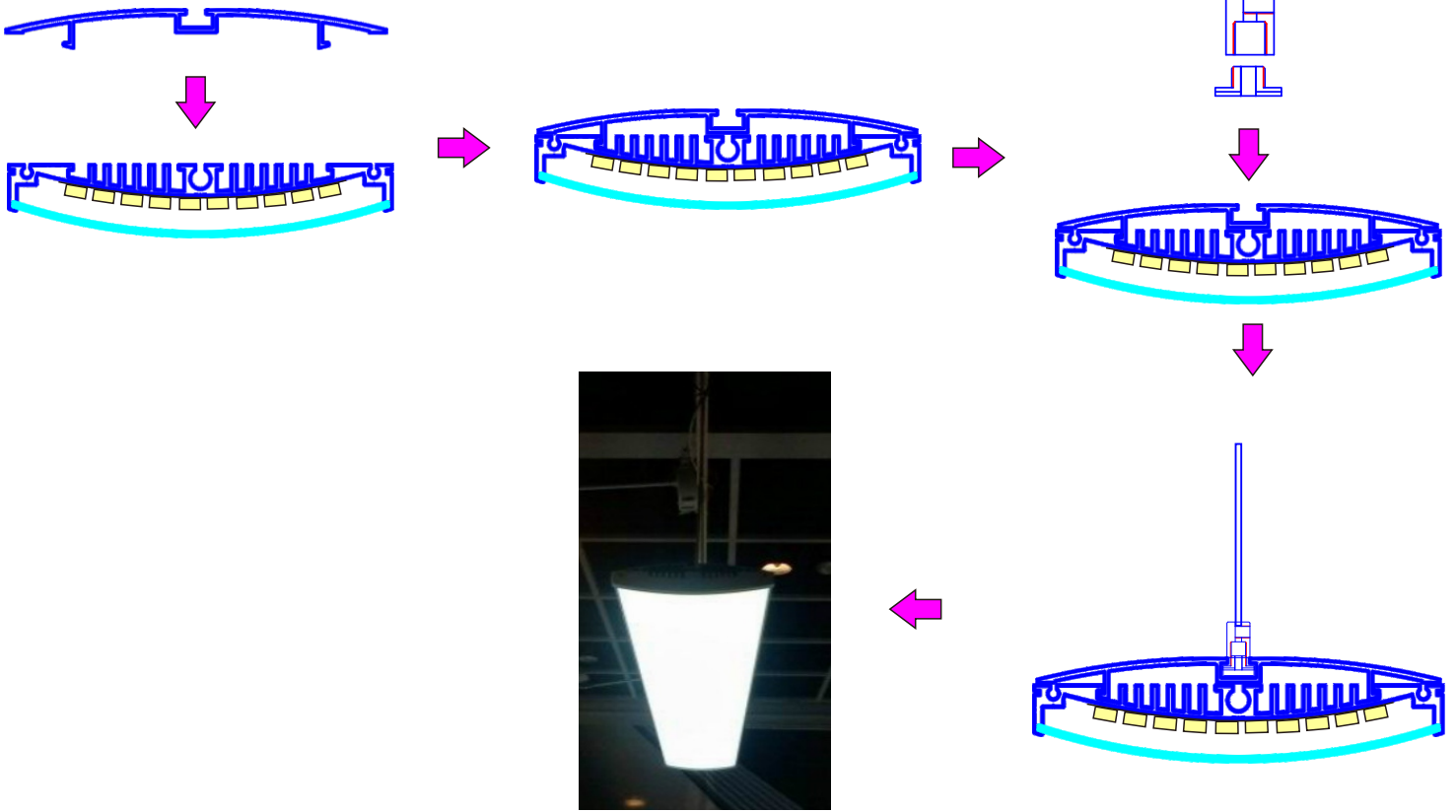

Fix the top joiner to the ceiling. Adjust the cable length to suit

Slide the suspension kits botto mjoiner into the mounting clip and rotate the joiner until locked into place

3, With PE001C Driver box

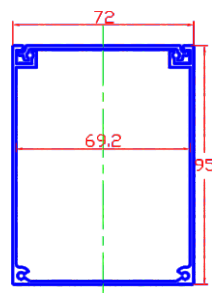

The driver could be put inside PE001C. Same installation as PE001B

