

LED Aluminum Profile-A3535

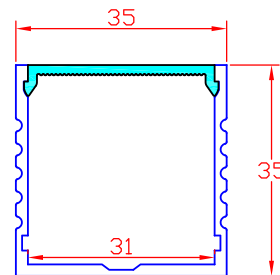

Customized Color can be ordered

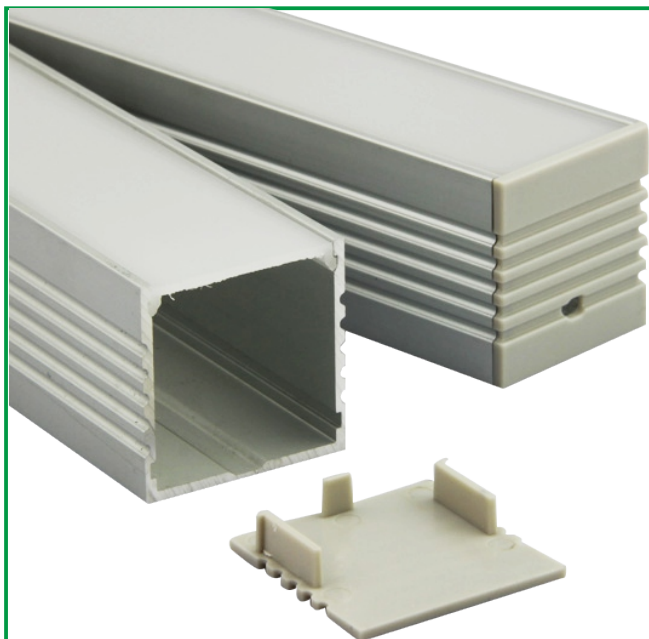

LED Aluminum profile 1~2meter

Service Environment and Installation:

1, With clip(Standard)

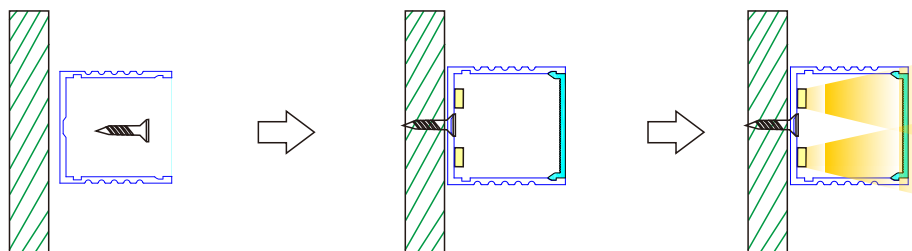

Milky PC Cover

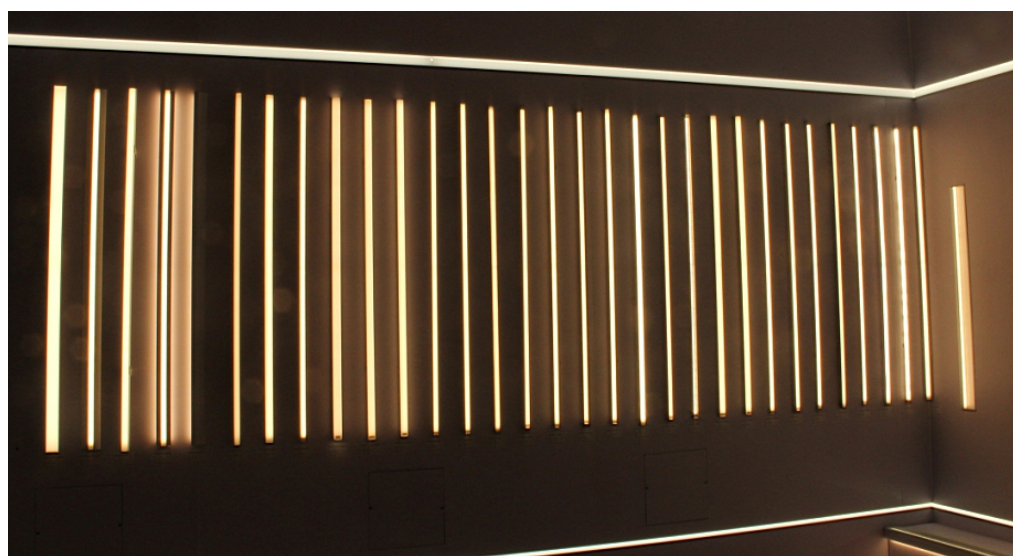

Plastic end caps
(1 with hole, 1 without hole)

3, With Steel Rope

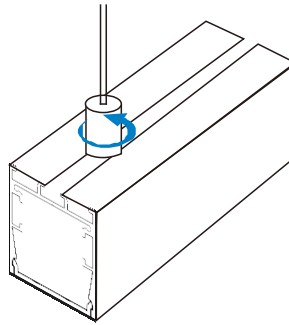

Slide the suspension kits bottom joiner into the aluminum base and rotate the joiner until locked into place

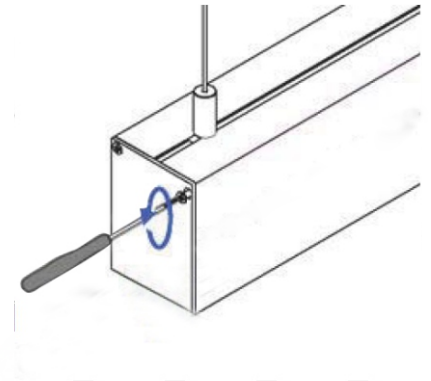

Screw the end caps

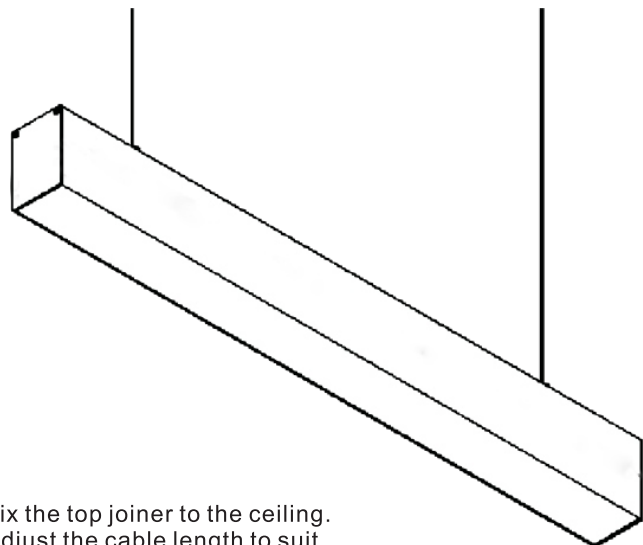

Fix the top joiner to the ceiling.
Adjust the cable length to suit