

LED Aluminum Profile-C7532

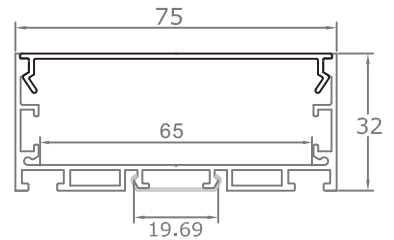

Customized Color can be ordered

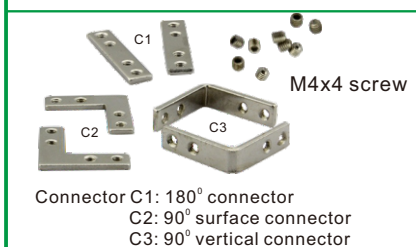
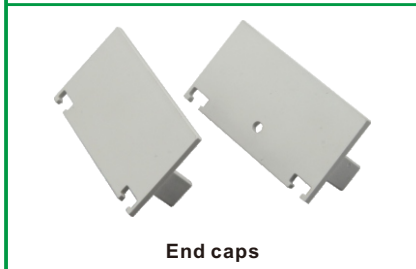

Service Environment and Installation:

1, With clip(Standard)

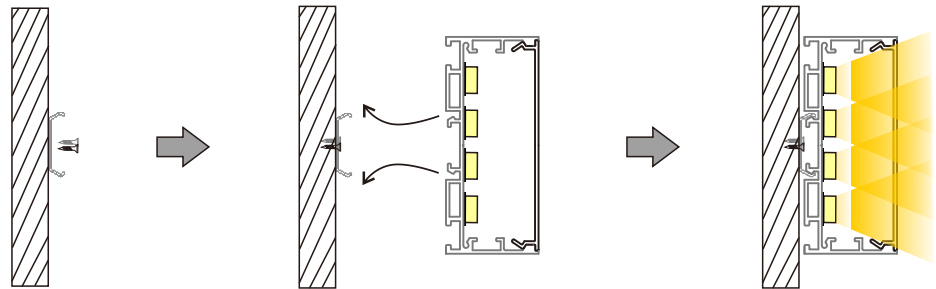

2, With Connector:

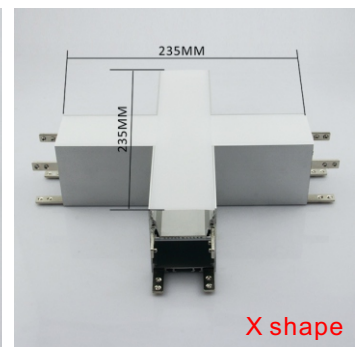
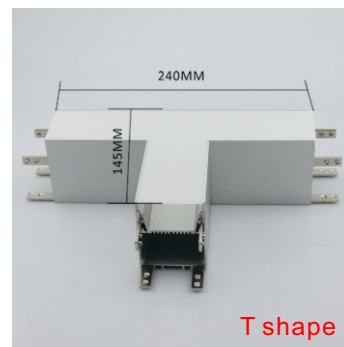
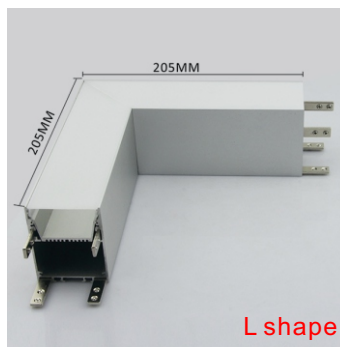

3, With Steel Rope



Slide the suspension kits bottom joiner into the mounting clip and rotate the joiner until locked into place

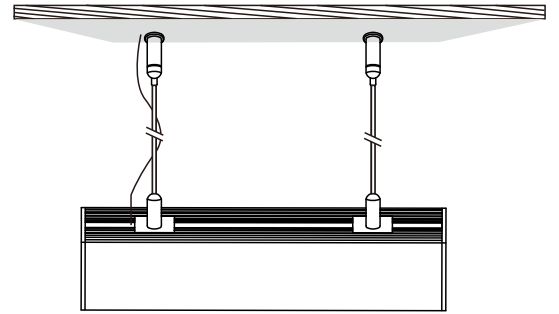

Fix the top joiner to the ceiling. Adjust the cable length to suit